



SIXTH EDITION

# JAVA™ PROGRAMMING

JOYCE FARRELL



[www.allitebooks.com](http://www.allitebooks.com)

This is an electronic version of the print textbook. Due to electronic rights restrictions, some third party content may be suppressed.

Editorial review has deemed that any suppressed content does not materially affect the overall learning experience.

The publisher reserves the right to remove content from this title at any time if subsequent rights restrictions require it.

For valuable information on pricing, previous editions, changes to current editions, and alternate formats, please visit [www.cengage.com/highered](http://www.cengage.com/highered) to search by ISBN#, author, title, or keyword for materials in your areas of interest.

SIXTH EDITION

# JAVA™ PROGRAMMING

JOYCE FARRELL



COURSE TECHNOLOGY  
CENGAGE Learning™

Australia • Brazil • Japan • Korea • Mexico • Singapore • Spain • United Kingdom • United States

[www.allitebooks.com](http://www.allitebooks.com)



**Java Programming, Sixth Edition**

Joyce Farrell

Executive Editor: Marie Lee

Acquisitions Editor: Brandi Shailer

Senior Product Manager: Alyssa Pratt

Development Editor: Dan Seiter

Editorial Assistant: Jacqueline Lacaire

Associate Marketing Manager:

Shanna Shelton

Senior Content Project Manager:

Jill Braiewa

Art Director: Faith Brosnan

Cover Designer: Bruce Bond

Cover Photo: ©istockphoto.com/

Dimitrije

Print Buyer: Julio Esperas

Copyeditor: Mark Goodin

Proofreader: Suzanne Huizenga

Indexer: Liz Cunningham

Compositor: Integra Software Services

© 2012 Course Technology, Cengage Learning

ALL RIGHTS RESERVED. No part of this work covered by the copyright herein may be reproduced, transmitted, stored or used in any form or by any means—graphic, electronic, or mechanical, including but not limited to photocopying, recording, scanning, digitizing, taping, Web distribution, information networks, or information storage and retrieval systems, except as permitted under Section 107 or 108 of the 1976 United States Copyright Act—without the prior written permission of the publisher.

For product information and technology assistance, contact us at  
**Cengage Learning Customer & Sales Support, 1-800-354-9706**

For permission to use material from this text or product,  
submit all requests online at [cengage.com/permissions](http://cengage.com/permissions)  
Further permissions questions can be e-mailed to  
[permissionrequest@cengage.com](mailto:permissionrequest@cengage.com)

Library of Congress Control Number: 2010941935

ISBN-13: 978-1-111-52944-4

ISBN-10: 1-111-52944-2

**Course Technology**

20 Channel Center Street  
Boston, MA 02210

Microsoft® is a registered trademark of the Microsoft Corporation.

Oracle and Java are registered trademarks of Oracle and/or its affiliates. Other names may be trademarks of their respective owners.

Some of the product names and company names used in this book have been used for identification purposes only and may be trademarks or registered trademarks of their respective manufacturers and sellers.

Any fictional data related to people, companies, or URLs used throughout this book is intended for instructional purposes only. At the time this book was printed, any such data was fictional and not belonging to any real people or companies.

Course Technology, a part of Cengage Learning, reserves the right to revise this publication and make changes from time to time in its content without notice.

The programs in this book are for instructional purposes only. They have been tested with care, but are not guaranteed for any particular intent beyond educational purposes. The author and the publisher do not offer any warranties or representations, nor do they accept any liabilities with respect to the programs.

Cengage Learning is a leading provider of customized learning solutions with office locations around the globe, including Singapore, the United Kingdom, Australia, Mexico, Brazil, and Japan. Locate your local office at: [www.cengage.com/global](http://www.cengage.com/global)

Cengage Learning products are represented in Canada by Nelson Education, Ltd.

To learn more about Course Technology, visit

[www.cengage.com/coursetechnology](http://www.cengage.com/coursetechnology)

Purchase any of our products at your local college store or at our preferred online store:  
[www.cengagebrain.com](http://www.cengagebrain.com)

Printed in the United States of America

1 2 3 4 5 6 7 17 16 15 14 13 12 11

# Brief Contents

	Preface . . . . .	xviii
<b>CHAPTER 1</b>	Creating Your First Java Classes . . . . .	<b>1</b>
<b>CHAPTER 2</b>	Using Data . . . . .	<b>51</b>
<b>CHAPTER 3</b>	Using Methods, Classes, and Objects . . . . .	<b>103</b>
<b>CHAPTER 4</b>	More Object Concepts . . . . .	<b>157</b>
<b>CHAPTER 5</b>	Making Decisions . . . . .	<b>211</b>
<b>CHAPTER 6</b>	Looping . . . . .	<b>259</b>
<b>CHAPTER 7</b>	Characters, Strings, and the <code>StringBuilder</code> . . . . .	<b>301</b>
<b>CHAPTER 8</b>	Arrays . . . . .	<b>341</b>
<b>CHAPTER 9</b>	Advanced Array Concepts . . . . .	<b>381</b>
<b>CHAPTER 10</b>	Introduction to Inheritance . . . . .	<b>425</b>
<b>CHAPTER 11</b>	Advanced Inheritance Concepts . . . . .	<b>469</b>
<b>CHAPTER 12</b>	Exception Handling . . . . .	<b>519</b>
<b>CHAPTER 13</b>	File Input and Output . . . . .	<b>579</b>
<b>CHAPTER 14</b>	Introduction to Swing Components . . . . .	<b>643</b>
<b>CHAPTER 15</b>	Advanced GUI Topics . . . . .	<b>699</b>
<b>CHAPTER 16</b>	Graphics . . . . .	<b>769</b>
<b>CHAPTER 17</b>	Applets, Images, and Sound . . . . .	<b>825</b>
<b>APPENDIX A</b>	Working with the Java Platform . . . . .	<b>869</b>
<b>APPENDIX B</b>	Learning About Data Representation . . . . .	<b>877</b>
<b>APPENDIX C</b>	Formatting Output . . . . .	<b>885</b>
<b>APPENDIX D</b>	Generating Random Numbers . . . . .	<b>897</b>
<b>APPENDIX E</b>	Javadoc . . . . .	<b>905</b>
	Glossary . . . . .	<b>913</b>
	Index . . . . .	<b>937</b>

# Contents

	Preface . . . . .	xviii
<b>CHAPTER 1</b>	<b>Creating Your First Java Classes . . . . .</b>	<b>1</b>
	Learning About Programming . . . . .	2
	Comparing Procedural and Object-Oriented	
	Programming Concepts . . . . .	5
	Procedural Programming . . . . .	5
	Object-Oriented Programming . . . . .	6
	Understanding Classes, Objects, and Encapsulation . . . . .	7
	Understanding Inheritance and Polymorphism . . . . .	9
	Features of the Java Programming Language . . . . .	10
	Java Program Types . . . . .	12
	Analyzing a Java Application that Produces Console Output . . . . .	13
	Understanding the Statement that Produces the Output . . . . .	13
	Understanding the First Class . . . . .	15
	Indent Style . . . . .	18
	Understanding the main() Method . . . . .	19
	Adding Comments to a Java Class . . . . .	21
	Saving, Compiling, Running, and Modifying a Java Application . . . . .	23
	Saving a Java Class . . . . .	23
	Compiling a Java Class . . . . .	23
	Running a Java Application . . . . .	25
	Modifying a Java Class . . . . .	25
	Creating a Java Application that Produces GUI Output . . . . .	27
	Correcting Errors and Finding Help . . . . .	29
	You Do It . . . . .	33
	Your First Application . . . . .	33
	Adding Comments to a Class . . . . .	34
	Modifying a Class . . . . .	35
	Creating a Dialog Box . . . . .	36
	Don't Do It . . . . .	37
	Key Terms . . . . .	39
	Chapter Summary . . . . .	42
	Review Questions . . . . .	43

Exercises . . . . .	46
Debugging Exercise . . . . .	48
Game Zone . . . . .	48

## CHAPTER 2

### Using Data . . . . . 51

Using Constants and Variables . . . . .	52
Declaring Variables . . . . .	53
Declaring Named Constants . . . . .	54
The Scope of Variables and Constants . . . . .	56
Pitfall: Forgetting That a Variable Holds One Value at a Time . . . . .	56
Learning About Integer Data Types . . . . .	57
Using the boolean Data Type . . . . .	59
Learning About Floating-Point Data Types . . . . .	61
Working with the char Data Type . . . . .	62
Displaying Data and Performing Arithmetic . . . . .	67
Performing Arithmetic . . . . .	69
Writing Arithmetic Statements Efficiently . . . . .	71
Pitfall: Not Understanding Imprecision in Floating-Point Numbers . . . . .	71
Understanding Numeric Type Conversion . . . . .	73
Using the Scanner Class for Keyboard Input . . . . .	76
Pitfall: Using nextLine() Following One of the Other Scanner Input Methods . . . . .	78
Using the JOptionPane Class for GUI Input . . . . .	81
Using Input Dialog Boxes . . . . .	81
Using Confirm Dialog Boxes . . . . .	85
You Do It . . . . .	87
Working with Numeric Values . . . . .	87
Accepting User Data . . . . .	89
Performing Arithmetic . . . . .	90
Experimenting with Java Programs . . . . .	91
Don't Do It . . . . .	92
Key Terms . . . . .	93
Chapter Summary . . . . .	96
Review Questions . . . . .	97
Exercises . . . . .	100
Debugging Exercise . . . . .	102
Game Zone . . . . .	102

## CHAPTER 3

### Using Methods, Classes, and Objects . . . . . 103

Creating Methods . . . . .	104
Adding Parameters to Methods . . . . .	108
Creating Methods That Require Multiple Parameters . . . . .	112

Creating Methods That Return Values . . . . .	114
Chaining Method Calls . . . . .	117
Learning About Class Concepts . . . . .	118
Creating a Class . . . . .	120
Creating Instance Methods in a Class . . . . .	123
Declaring Objects and Using Their Methods . . . . .	126
Understanding Data Hiding . . . . .	128
Organizing Classes . . . . .	129
An Introduction to Using Constructors . . . . .	132
Understanding that Classes are Data Types . . . . .	134
You Do It . . . . .	137
Creating a Static Method That Requires No Arguments and Returns No Values . . . . .	137
Calling a Static Method from Another Class . . . . .	139
Creating a Static Method That Accepts Arguments and Returns Values . . . . .	140
Creating a Class That Contains Instance Fields and Methods . . . . .	142
Creating a Class That Instantiates Objects of Another Class . . . . .	143
Adding a Constructor to a Class . . . . .	144
Creating a More Complete Class . . . . .	145
Don't Do It . . . . .	145
Key Terms . . . . .	146
Chapter Summary . . . . .	148
Review Questions . . . . .	149
Exercises . . . . .	151
Debugging Exercise . . . . .	154
Game Zone . . . . .	154
<b>CHAPTER 4</b> <b>More Object Concepts . . . . .</b>	<b>157</b>
Understanding Blocks and Scope . . . . .	158
Overloading a Method . . . . .	165
Learning About Ambiguity . . . . .	167
Using Constructors with Parameters . . . . .	171
Overloading Constructors . . . . .	172
Learning About the <code>this</code> Reference . . . . .	173
Using the <code>this</code> Reference to Make Overloaded Constructors More Efficient . . . . .	176
Using <code>static</code> Variables . . . . .	178
Using Constant Fields . . . . .	181
Using Automatically Imported, Prewritten Constants and Methods . . . . .	182
Using the <code>GregorianCalendar</code> Class . . . . .	184
Understanding Composition . . . . .	189
A Brief Look at Nested and Inner Classes . . . . .	191



You Do It . . . . .	193
Demonstrating Scope . . . . .	193
Overloading Methods . . . . .	195
Creating Overloaded Constructors . . . . .	196
Using an Explicitly Imported Prewritten Class . . . . .	198
Creating an Interactive Application with a Timer . . . . .	199
Don't Do It . . . . .	201
Key Terms . . . . .	201
Chapter Summary . . . . .	202
Review Questions . . . . .	203
Exercises . . . . .	206
Debugging Exercise . . . . .	208
Game Zone . . . . .	209

## CHAPTER 5 Making Decisions . . . . . 211

Planning Decision-Making Logic . . . . .	212
The <code>if</code> and <code>if...else</code> Structures . . . . .	214
Pitfall: Misplacing a Semicolon in an <code>if</code> Statement . . . . .	215
Pitfall: Using the Assignment Operator Instead of the Equivalency Operator . . . . .	216
Pitfall: Attempting to Compare Objects Using the Relational Operators . . . . .	216
The <code>if...else</code> Structure . . . . .	217
Using Multiple Statements in an <code>if</code> or <code>if...else</code> Structure . . . . .	218
Nesting <code>if</code> and <code>if...else</code> Statements . . . . .	222
Using Logical AND and OR Operators . . . . .	225
Making Accurate and Efficient Decisions . . . . .	227
Using <code>&amp;&amp;</code> and <code>  </code> Appropriately . . . . .	231
Using the <code>switch</code> Statement . . . . .	232
Using the Conditional and NOT Operators . . . . .	236
Using the NOT Operator . . . . .	237
Understanding Operator Precedence . . . . .	238
You Do It . . . . .	241
Using an <code>if...else</code> . . . . .	241
Creating an Event Class to Use in a Decision-Making Application . . . . .	242
Writing an Application that Uses the Event Class . . . . .	243
Using the <code>switch</code> Statement . . . . .	246
Don't Do It . . . . .	246
Key Terms . . . . .	247
Chapter Summary . . . . .	248
Review Questions . . . . .	249

	Exercises . . . . .	252
	Debugging Exercise . . . . .	256
	Game Zone . . . . .	256
<b>CHAPTER 6</b>	<b>Looping . . . . .</b>	<b>259</b>
	Learning About the Loop Structure . . . . .	260
	Creating <code>while</code> Loops . . . . .	261
	Writing a Definite <code>while</code> Loop . . . . .	261
	Writing an Indefinite <code>while</code> Loop . . . . .	266
	Using Shortcut Arithmetic Operators . . . . .	270
	Creating a <code>for</code> Loop . . . . .	273
	Learning How and When to Use a <code>do...while</code> Loop . . . . .	275
	Learning About Nested Loops . . . . .	278
	Improving Loop Performance . . . . .	281
	Avoiding Unnecessary Operations . . . . .	281
	Considering the Order of Evaluation of Short-Circuit Operators . . . . .	282
	Comparing to Zero . . . . .	282
	Employing Loop Fusion . . . . .	284
	You Do It . . . . .	285
	Writing a Loop to Validate Data Entries . . . . .	285
	Working with Prefix and Postfix Increment Operators . . . . .	286
	Working with Definite Loops . . . . .	288
	Working with Nested Loops . . . . .	289
	Don't Do It . . . . .	290
	Key Terms . . . . .	291
	Chapter Summary . . . . .	292
	Review Questions . . . . .	293
	Exercises . . . . .	296
	Debugging Exercise . . . . .	298
	Game Zone . . . . .	298
<b>CHAPTER 7</b>	<b>Characters, Strings, and the <code>StringBuilder</code> . . . . .</b>	<b>301</b>
	Understanding String Data Problems . . . . .	302
	Manipulating Characters . . . . .	303
	Declaring and Comparing <code>String</code> Objects . . . . .	307
	Comparing <code>String</code> Values . . . . .	308
	Using Other <code>String</code> Methods . . . . .	312
	Converting <code>Strings</code> to Numbers . . . . .	316
	Learning About the <code>StringBuilder</code> and <code>StringBuffer</code>	
	Classes . . . . .	319
	You Do It . . . . .	324
	Using <code>String</code> Class Methods . . . . .	324

	Converting a <code>String</code> to an Integer . . . . .	326
	Using <code>StringBuilder</code> Methods . . . . .	327
	Don't Do It . . . . .	329
	Key Terms . . . . .	329
	Chapter Summary . . . . .	331
	Review Questions . . . . .	331
	Exercises . . . . .	334
	Debugging Exercise . . . . .	337
	Game Zone . . . . .	337
<b>CHAPTER 8</b>	<b>Arrays . . . . .</b>	<b>341</b>
	Declaring and Initializing an Array . . . . .	342
	Initializing an Array . . . . .	344
	Using Subscripts with an Array . . . . .	346
	Declaring and Using Arrays of Objects . . . . .	349
	Using the Enhanced <code>for</code> Loop . . . . .	350
	Manipulating Arrays of <code>Strings</code> . . . . .	350
	Searching an Array . . . . .	352
	Searching an Array for a Range Match . . . . .	356
	Passing Arrays to and Returning Arrays from Methods . . . . .	359
	Returning an Array from a Method . . . . .	362
	You Do It . . . . .	363
	Creating and Populating an Array . . . . .	363
	Initializing an Array . . . . .	363
	Using a <code>for</code> Loop to Access Array Elements . . . . .	364
	Creating Parallel Arrays to Eliminate Nested <code>if</code> Statements . . . . .	364
	Creating an Application with an Array of Objects . . . . .	366
	Creating an Interactive Application That Creates an Array of Objects . . . . .	367
	Passing an Array to a Method . . . . .	369
	Don't Do It . . . . .	370
	Key Terms . . . . .	371
	Chapter Summary . . . . .	372
	Review Questions . . . . .	372
	Exercises . . . . .	375
	Debugging Exercise . . . . .	378
	Game Zone . . . . .	378
<b>CHAPTER 9</b>	<b>Advanced Array Concepts . . . . .</b>	<b>381</b>
	Sorting Array Elements . . . . .	382
	Sorting Arrays of Objects . . . . .	385
	Using Two-Dimensional and Other Multidimensional Arrays . . . . .	388

Passing a Two-Dimensional Array to a Method . . . . .	390
Using the <code>length</code> Field with a Two-Dimensional Array . . . . .	391
Understanding Ragged Arrays . . . . .	392
Using Other Multidimensional Arrays . . . . .	392
Using the <code>Arrays</code> Class . . . . .	393
Using the <code>ArrayList</code> Class . . . . .	398
Understanding the Limitations of the <code>ArrayList</code> Class . . . . .	403
Creating Enumerations . . . . .	404
You Do It . . . . .	409
Using a Two-Dimensional Array . . . . .	409
Using <code>Arrays</code> Class Methods . . . . .	411
Creating Enumerations . . . . .	413
Don't Do It . . . . .	415
Key Terms . . . . .	415
Chapter Summary . . . . .	416
Review Questions . . . . .	417
Exercises . . . . .	420
Debugging Exercise . . . . .	421
Game Zone . . . . .	421

## CHAPTER 10 Introduction to Inheritance . . . . . 425

Learning About the Concept of Inheritance . . . . .	426
Inheritance Terminology . . . . .	429
Extending Classes . . . . .	430
Overriding Superclass Methods . . . . .	432
Calling Constructors During Inheritance . . . . .	434
Using Superclass Constructors That Require Arguments . . . . .	436
Accessing Superclass Methods . . . . .	438
Comparing <code>this</code> and <code>super</code> . . . . .	440
Employing Information Hiding . . . . .	441
Methods You Cannot Override . . . . .	443
A Subclass Cannot Override <code>static</code> Methods in Its Superclass . . . . .	443
A Subclass Cannot Override <code>final</code> Methods in Its Superclass . . . . .	446
A Subclass Cannot Override Methods in a <code>final</code> Superclass . . . . .	448
You Do It . . . . .	450
Creating a Superclass and an Application to Use It . . . . .	450
Creating a Subclass and an Application to Use It . . . . .	452
Understanding the Role of Constructors in Inheritance . . . . .	454
Inheritance When the Superclass Requires Constructor Arguments . . . . .	456
Don't Do It . . . . .	458
Key Terms . . . . .	458
Chapter Summary . . . . .	459

	Review Questions . . . . .	460
	Exercises . . . . .	463
	Debugging Exercise . . . . .	467
	Game Zone . . . . .	467
<b>CHAPTER 11</b>	<b>Advanced Inheritance Concepts . . . . .</b>	<b>469</b>
	Creating and Using Abstract Classes . . . . .	470
	Using Dynamic Method Binding . . . . .	474
	Using a Superclass as a Method Parameter Type . . . . .	476
	Creating Arrays of Subclass Objects . . . . .	477
	Using the <code>Object</code> Class and Its Methods . . . . .	479
	Using the <code>toString()</code> Method . . . . .	480
	Using the <code>equals()</code> Method . . . . .	483
	Using Inheritance to Achieve Good Software Design . . . . .	486
	Creating and Using Interfaces . . . . .	487
	Creating Interfaces to Store Related Constants . . . . .	492
	Creating and Using Packages . . . . .	494
	You Do It . . . . .	496
	Creating an Abstract Class . . . . .	496
	Extending an Abstract Class . . . . .	497
	Extending an Abstract Class with a Second Subclass . . . . .	499
	Instantiating Objects from Subclasses . . . . .	500
	Using Object References . . . . .	501
	Using an Interface . . . . .	502
	Creating a Package . . . . .	504
	Don't Do It . . . . .	507
	Key Terms . . . . .	507
	Chapter Summary . . . . .	508
	Review Questions . . . . .	509
	Exercises . . . . .	512
	Debugging Exercise . . . . .	516
	Game Zone . . . . .	516
<b>CHAPTER 12</b>	<b>Exception Handling . . . . .</b>	<b>519</b>
	Learning About Exceptions . . . . .	520
	Trying Code and Catching <code>Exceptions</code> . . . . .	525
	Throwing and Catching Multiple <code>Exceptions</code> . . . . .	530
	Using the <code>finally</code> Block . . . . .	534
	Understanding the Advantages of Exception Handling . . . . .	537
	Specifying the <code>Exceptions</code> a Method Can Throw . . . . .	539
	Tracing <code>Exceptions</code> Through the Call Stack . . . . .	544
	Creating Your Own <code>Exceptions</code> . . . . .	548

Using Assertions . . . . .	551
You Do It . . . . .	555
Throwing and Catching Exceptions . . . . .	555
Creating a Class That Automatically Throws Exceptions . . . . .	558
Creating a Class That Passes on an Exception . . . . .	559
Creating an Application That Can Catch Exceptions . . . . .	560
Extending a Class That Throws Exceptions . . . . .	562
Creating an Exception Class . . . . .	563
Using an Exception You Created . . . . .	564
Don't Do It . . . . .	567
Key Terms . . . . .	568
Chapter Summary . . . . .	569
Review Questions . . . . .	570
Exercises . . . . .	573
Debugging Exercise . . . . .	577
Game Zone . . . . .	578
<b>CHAPTER 13</b> File Input and Output . . . . .	<b>579</b>
Understanding Computer Files . . . . .	580
Using the Path Class . . . . .	581
Creating a Path . . . . .	582
Retrieving Information about a Path . . . . .	583
Converting a Relative Path to an Absolute One . . . . .	584
Checking File Accessibility . . . . .	585
Deleting a Path . . . . .	587
Determining File Attributes . . . . .	588
File Organization, Streams, and Buffers . . . . .	591
Using Java's IO Classes . . . . .	594
Writing to a File . . . . .	597
Reading from a File . . . . .	599
Creating and Using Sequential Data Files . . . . .	601
Learning about Random Access Files . . . . .	607
Writing Records to a Random Access Data File . . . . .	611
Reading Records from a Random Access Data File . . . . .	618
Accessing a Random Access File Sequentially . . . . .	618
Accessing a Random Access File Randomly . . . . .	620
You Do It . . . . .	622
Creating Multiple Random Access Files . . . . .	622
Writing a Method to Create an Empty File . . . . .	624
Adding Data Entry Capability to the Program . . . . .	625
Setting Up a Program to Read the Created Files . . . . .	628
Displaying File Statistics . . . . .	629

Reading a File Sequentially . . . . .	630
Reading a File Randomly . . . . .	632
Don't Do It . . . . .	633
Key Terms . . . . .	633
Chapter Summary . . . . .	635
Review Questions . . . . .	636
Exercises . . . . .	639
Debugging Exercise . . . . .	641
Game Zone . . . . .	641

## **CHAPTER 14** Introduction to Swing Components . . . . . **643**

Understanding Swing Components . . . . .	644
Using the JFrame Class . . . . .	645
Customizing a JFrame's Appearance . . . . .	648
Using the JLabel Class . . . . .	650
Changing a JLabel's Font . . . . .	652
Using a Layout Manager . . . . .	654
Extending the JFrame Class . . . . .	656
Adding JTextField, JButton, and Tool Tips to a JFrame . . . . .	659
Adding JTextField . . . . .	659
Adding JButton . . . . .	661
Using Tool Tips . . . . .	663
Learning About Event-Driven Programming . . . . .	664
Preparing Your Class to Accept Event Messages . . . . .	665
Telling Your Class to Expect Events to Happen . . . . .	665
Telling Your Class How to Respond to Events . . . . .	665
Using the setEnabled() Method . . . . .	669
Understanding Swing Event Listeners . . . . .	669
Using the JCheckBox, ButtonGroup, and JComboBox	
Classes . . . . .	672
The JCheckBox Class . . . . .	672
The ButtonGroup Class . . . . .	676
The JComboBox Class . . . . .	677
You Do It . . . . .	679
Creating a JFrame . . . . .	679
Ending an Application When a JFrame Closes . . . . .	681
Adding Components to a JFrame . . . . .	681
Adding Functionality to a JButton and a JTextField . . . . .	682
Distinguishing Event Sources . . . . .	684
Including JCheckBoxes in an Application . . . . .	685
Don't Do It . . . . .	688
Key Terms . . . . .	689

**CHAPTER 15**

Chapter Summary . . . . .	691
Review Questions . . . . .	692
Exercises . . . . .	695
Debugging Exercise . . . . .	696
Game Zone . . . . .	696
<b>Advanced GUI Topics . . . . .</b>	<b>699</b>
Understanding the Content Pane . . . . .	700
Using Color . . . . .	702
Learning More About Layout Managers . . . . .	705
Using BorderLayout . . . . .	706
Using FlowLayout . . . . .	708
Using GridLayout . . . . .	710
Using CardLayout . . . . .	712
Using Advanced Layout Managers . . . . .	714
Using the JPanel Class . . . . .	714
Creating JScrollPane . . . . .	722
A Closer Look at Events and Event Handling . . . . .	725
An Event-Handling Example: KeyListener . . . . .	728
Using AWTEvent Class Methods . . . . .	730
Understanding x- and y-Coordinates . . . . .	732
Handling Mouse Events . . . . .	733
Using Menus . . . . .	738
Using JCheckBoxMenuItem and JRadioButtonMenuItem Objects . . . . .	741
Using addSeparator() . . . . .	743
Using setMnemonic() . . . . .	743
You Do It . . . . .	744
Using BorderLayout . . . . .	744
Using Fewer than Five Components with the BorderLayout Manager . . . . .	746
Using FlowLayout . . . . .	747
Using GridLayout . . . . .	748
Using CardLayout . . . . .	749
Viewing All the Cards in CardLayout . . . . .	750
Using a Menu Bar and JPanel's . . . . .	751
Don't Do It . . . . .	755
Key Terms . . . . .	756
Chapter Summary . . . . .	757
Review Questions . . . . .	759
Exercises . . . . .	761
Debugging Exercise . . . . .	763
Game Zone . . . . .	763



Learning About the <code>paint()</code> and <code>repaint()</code> Methods . . . .	770
Using the <code>setLocation()</code> Method . . . . .	772
Creating Graphics Objects . . . . .	774
Using the <code>drawString()</code> Method . . . . .	775
Using the <code>setFont()</code> and <code>setColor()</code> Methods . . . . .	776
Using Color . . . . .	777
Drawing Lines and Shapes . . . . .	778
Drawing Lines . . . . .	778
Drawing Rectangles . . . . .	779
Creating Shadowed Rectangles . . . . .	781
Drawing Ovals . . . . .	782
Drawing Arcs . . . . .	783
Creating Polygons . . . . .	784
Copying an Area . . . . .	786
Learning More About Fonts . . . . .	787
Discovering Screen Statistics Using the <code>Toolkit</code> Class . . . .	789
Discovering Font Statistics . . . . .	790
Drawing with Java 2D Graphics . . . . .	792
Specifying the Rendering Attributes . . . . .	792
Setting a Drawing Stroke . . . . .	794
Creating Objects to Draw . . . . .	795
You Do It . . . . .	798
Using the <code>drawString()</code> Method . . . . .	798
Using Fonts and Colors . . . . .	799
Creating Your Own Graphics Object . . . . .	800
Examining Screen Coordinates . . . . .	801
Creating a Drawing . . . . .	802
Copying an Area . . . . .	803
Using <code>FontMetrics</code> Methods to Compare Fonts . . . . .	805
Using <code>FontMetrics</code> Methods to Place a Border Around a String . . . . .	807
Using Drawing Strokes . . . . .	809
Working with Shapes . . . . .	810
Don't Do It . . . . .	812
Key Terms . . . . .	812
Chapter Summary . . . . .	814
Review Questions . . . . .	815
Exercises . . . . .	818
Debugging Exercise . . . . .	821
Game Zone . . . . .	821

<b>CHAPTER 17</b>	<b>Applets, Images, and Sound . . . . .</b>	<b>825</b>
	Introducing Applets . . . . .	826
	Understanding the <code>JApplet</code> Class . . . . .	826
	Running an Applet . . . . .	827
	Writing an HTML Document to Host an Applet . . . . .	828
	Creating a <code>JApplet</code> that Contains an <code>init()</code> Method . . . . .	830
	Working with <code>JApplet</code> Components . . . . .	832
	Understanding the <code>JApplet</code> Life Cycle . . . . .	835
	The <code>init()</code> Method . . . . .	836
	The <code>start()</code> Method . . . . .	836
	The <code>stop()</code> Method . . . . .	836
	The <code>destroy()</code> Method . . . . .	836
	Understanding Multimedia and Using Images . . . . .	837
	Adding Images to <code>JApplets</code> . . . . .	838
	Using <code>ImageIcons</code> . . . . .	841
	Adding Sound to <code>JApplets</code> . . . . .	844
	You Do It . . . . .	846
	Creating an HTML Document to Host an Applet . . . . .	846
	Creating and Running a <code>JApplet</code> . . . . .	846
	Running a <code>JApplet</code> in Your Web Browser . . . . .	847
	Creating a More Complicated <code>JApplet</code> . . . . .	848
	Making the <code>JApplet</code> 's Button Respond to Events . . . . .	849
	Understanding the Applet Life Cycle . . . . .	850
	Displaying Images . . . . .	854
	Playing Sounds . . . . .	855
	Don't Do It . . . . .	857
	Key Terms . . . . .	857
	Chapter Summary . . . . .	858
	Review Questions . . . . .	859
	Exercises . . . . .	861
	Debugging Exercise . . . . .	864
	Game Zone . . . . .	864
<b>APPENDIX A</b>	<b>Working with the Java Platform . . . . .</b>	<b>869</b>
	Configuring Windows to Work with the Java SE Development Kit . . . . .	870
	Finding the Command Prompt . . . . .	871
	Command Prompt Anatomy . . . . .	871
	Changing Directories . . . . .	871
	Setting the <code>class</code> and <code>classpath</code> Variables . . . . .	872
	Changing a File's Name . . . . .	873
	Compiling and Executing a Java Program . . . . .	873

	Using Notepad to Save and Edit Source Code . . . . .	874
	Using TextPad to Work with Java . . . . .	874
	Key Terms . . . . .	875
<b>APPENDIX B</b>	<b>Learning About Data Representation . . . . .</b>	<b>877</b>
	Understanding Numbering Systems . . . . .	878
	Representing Numeric Values . . . . .	880
	Representing Character Values . . . . .	881
	Key Terms . . . . .	883
<b>APPENDIX C</b>	<b>Formatting Output . . . . .</b>	<b>885</b>
	Rounding Numbers . . . . .	886
	Using the <code>printf()</code> Method . . . . .	887
	Specifying a Number of Decimal Places to Display with <code>printf()</code> . . . . .	891
	Specifying a Field Size with <code>printf()</code> . . . . .	891
	Using the Optional Argument Index with <code>printf()</code> . . . . .	892
	Using the <code>DecimalFormat</code> Class . . . . .	893
	Key Terms . . . . .	894
<b>APPENDIX D</b>	<b>Generating Random Numbers . . . . .</b>	<b>897</b>
	Understanding Random Numbers Generated by Computers . . . . .	898
	Using the <code>Math.random()</code> Method . . . . .	899
	Using the <code>Random</code> Class . . . . .	900
	Key Terms . . . . .	903
<b>APPENDIX E</b>	<b>Javadoc . . . . .</b>	<b>905</b>
	The Javadoc Documentation Generator . . . . .	906
	Javadoc Comment Types . . . . .	906
	Generating Javadoc Documentation . . . . .	908
	Specifying Visibility of Javadoc Documentation . . . . .	911
	Key Terms . . . . .	912
	 Glossary . . . . .	 <b>913</b>
	 Index . . . . .	 <b>937</b>

# Preface

*Java Programming, Sixth Edition* provides the beginning programmer with a guide to developing applications using the Java programming language. Java is popular among professional programmers because it can be used to build visually interesting graphical user interface (GUI) and Web-based applications. Java also provides an excellent environment for the beginning programmer—a student quickly can build useful programs while learning the basics of structured and object-oriented programming techniques.

This textbook assumes that you have little or no programming experience. This book provides a solid background in good object-oriented programming techniques and introduces terminology using clear, familiar language. The writing is nontechnical and emphasizes good programming practices. The examples are business examples; they do not assume a mathematical background beyond high-school business math. In addition, the examples illustrate only one or two major points; they do not contain so many features that you become lost following irrelevant and extraneous details. The explanations in this textbook are written clearly in straightforward sentences, making it easier for native and non-native English speakers alike to master the programming concepts. Complete, working code examples appear frequently in each chapter; these examples help students make the transition from the theoretical to the practical. The code presented in each chapter can also be downloaded from the publisher's Web site, so that students can easily run the programs and experiment with changes to them.

## Organization and Coverage

*Java Programming, Sixth Edition* presents Java programming concepts, enforcing good style, logical thinking, and the object-oriented paradigm. Objects are covered right from the beginning, earlier than in many other textbooks. You create your first Java program in Chapter 1. Chapters 2, 3, and 4 increase your understanding of how data, classes, objects, and methods interact in an object-oriented environment.

Chapters 5 and 6 explore input and repetition structures, which are the backbone of programming logic and essential to creating useful programs in any language. You learn the special considerations of string and array manipulation in Chapters 7, 8, and 9.

Chapters 10, 11, and 12 thoroughly cover inheritance (the object-oriented concept that allows you to develop new objects quickly by adapting the features of existing ones) and exception handling (the object-oriented approach to handling errors). Both are important concepts in object-oriented design. Chapter 13 provides information on handling files so you can permanently store and retrieve program output.

Chapters 14 and 15 introduce GUI Swing components—Java’s visually pleasing, user-friendly widgets—and their layout managers. Chapters 16 and 17 show you ways to provide interactive excitement using graphics, applets, images, and sound.

In every chapter, *Java Programming, Sixth Edition* follows the text explanation with a “You Do It” section that contains step-by-step exercises to illustrate the concepts just learned, reinforcing the student’s understanding and promoting concept retention. Creating the programs in the step-by-step examples also provides students with successful experiences using the language; finishing the examples provides them with models for their own creations.

The student using *Java Programming, Sixth Edition* builds applications from the bottom up, rather than starting with existing objects. This facilitates a deeper understanding of the concepts used in object-oriented programming, and engenders appreciation for the existing objects students use as their knowledge of the language advances. When students complete this book, they will know how to modify and create simple Java programs and will have the tools to create more complex examples. They also will have a fundamental knowledge of object-oriented programming, which will serve them well in advanced Java courses or in studying other object-oriented languages such as C++, C#, and Visual Basic.

## Features of the Text

*Java Programming, Sixth Edition* is a superior textbook because it includes the following features:

**OBJECTIVES:** Each chapter begins with a list of objectives so you know the topics that will be presented in the chapter. In addition to providing a quick reference to topics covered, this feature provides a useful study aid.

**NOTES:** These highlighted tips provide additional information—for example, an alternative method of performing a procedure, another term for a concept, background information on a technique, or a common error to avoid.

**FIGURES:** Each chapter contains many figures. Code figures are most frequently 25 lines or fewer, illustrating one concept at a time. Frequent screen shots show exactly how program output appears. Callouts appear where needed to emphasize a point.

**COLOR:** The code figures in each chapter contain all Java keywords in blue. This helps students identify keywords more easily, distinguishing them from programmer-selected names.

**FILES:** More than 200 student files can be downloaded from the publisher’s Web site. Most files contain the code presented in the figures in each chapter; students can run the code for themselves, view the output, and make changes to the code to observe the effects. Other files include debugging exercises that help students improve their programming skills.

**TWO TRUTHS AND A LIE:** A short quiz reviews each chapter section, with answers provided. This quiz contains three statements from the preceding section of text—two statements are true and one is false. Over the years, students have requested answers to problems, but we



have hesitated to distribute them in case instructors want to use problems as assignments or test questions. These true-false mini-quizzes provide students with immediate feedback as they read, without “giving away” answers to the existing multiple-choice questions and programming problems.

xx

**YOU DO IT:** In each chapter, step-by-step exercises help students create multiple working programs that emphasize the logic a programmer uses in choosing statements to include. This section provides a means for students to achieve success on their own—even those in online or distance learning classes.

**DON'T DO IT:** This section at the end of each chapter summarizes common mistakes and pitfalls that plague new programmers while learning the current topic.

**KEY TERMS:** Each chapter includes a list of newly introduced vocabulary, shown in the order of appearance in the text. The list of key terms provides a mini-review of the major concepts in the chapter.

**SUMMARY:** Following each chapter is a summary that recaps the programming concepts and techniques covered in the chapter. This feature provides a concise means for students to check their understanding of the main points in each chapter.

**REVIEW QUESTIONS:** Each chapter includes 20 multiple-choice questions that serve as a review of chapter topics.

**EXERCISES:** Each chapter concludes with meaningful programming exercises that provide additional practice of the skills and concepts learned in the chapter. These exercises vary in difficulty and are designed to allow exploration of logical programming concepts.



**GAME ZONE:** Each chapter provides one or more exercises in which students create interactive games using the programming techniques learned up to that point; 70 game programs are suggested in the book. The games are fun to create and play; writing them motivates students to master the necessary programming techniques. Students might exchange completed game programs with each other, suggesting improvements and discovering alternate ways to accomplish tasks.

**APPENDICES:** This edition includes useful appendices on working with the Java platform, data representation, formatting output, generating random numbers, and creating Javadoc comments.

**GLOSSARY:** A glossary contains definitions for all key terms in the book, presented in alphabetical order.

**QUALITY:** Every program example, exercise, and game solution was tested by the author and then tested again by a Quality Assurance team using a prerelease snapshot version of Java Standard Edition (SE) 7, the most recent version available. (The external version number used by Sun Microsystems is 7.0; the internal version number is 1.7.0. For more information on the features of the JDK, visit <http://www.oracle.com/technetwork/java/index.html>.)

## New to This Edition!

This edition introduces the following pedagogical improvements:

- Programs are written and tested using Java 7, the newest edition of the Java platform.
- Video lessons accompany each chapter. The author created and narrated these videos, which enhance explanations in the text and help to clarify difficult topics. The videos are a great supplement to online classes.
- Array coverage is split into two chapters, allowing instructors to cover introductory and advanced array topics separately, and providing more detail and exercises using arrays.
- This book covers the `Path` class, which is new in Java 7 and replaces the functionality of the `File` class. The *File Input and Output* chapter has been completely rewritten to describe state-of-the-art file handling techniques.
- This book covers using `Strings` in `switch` statements, which is a new feature in Java 7.
- This book covers catching multiple `Exception` types in a single `catch` block, which is a new feature of Java 7.

xxi

## CourseMate

The more you study, the better the results. Make the most of your study time by accessing everything you need to succeed in one place. Read your textbook, take notes, review flashcards, watch videos, and take practice quizzes online. CourseMate goes beyond the book to deliver what you need! Learn more at [www.cengage.com/coursemate](http://www.cengage.com/coursemate).

The *Java Programming* CourseMate includes:

- **Debugging Exercises:** Four error-filled programs accompany each chapter. By debugging these programs, students can gain expertise in program logic in general and the Java programming language in particular.
- **Video Lessons:** Each chapter is accompanied by at least three video lessons that help to explain important chapter concepts. These videos were created and narrated by the author.
- An interactive eBook, quizzes, flashcards, and more!



Instructors may add CourseMate to the textbook package, or students may purchase CourseMate directly at [www.cengagebrain.com](http://www.cengagebrain.com).

## Instructor Resources

The following supplemental materials are available when this book is used in a classroom setting.

**ELECTRONIC INSTRUCTOR'S MANUAL:** The Instructor's Manual that accompanies this textbook contains additional instructional material to assist in class preparation, including items such as Sample Syllabi, Chapter Outlines, Technical Notes, Lecture Notes, Quick

Quizzes, Teaching Tips, Discussion Topics, and Key Terms. Additional exercises in the Instructor's Manual include:

- **Tough Questions:** Each chapter is accompanied by two or more fairly difficult questions that are typical of what an applicant might encounter in a technical job interview. These questions are often open-ended; some involve coding, and others might involve research.
- **Up for Discussion:** Each chapter is supported by a few thought-provoking questions concerning programming in general or Java in particular. The questions can be used to start classroom or online discussions, or to develop and encourage research, writing, and language skills.

**EXAMVIEW®:** This textbook is accompanied by ExamView, a powerful testing software package that allows instructors to create and administer printed, computer (LAN-based), and Internet-based exams. ExamView includes hundreds of questions that correspond to the topics covered in this text, enabling students to generate detailed study guides that include page references for further review. The computer-based and Internet testing components allow students to take exams at their computers, and they save the instructor time by grading each exam automatically.

**POWERPOINT PRESENTATIONS:** Microsoft PowerPoint slides are available for each chapter. These slides are provided as a teaching aid for classroom presentation, to make available to students on the network for chapter review, or to be printed for classroom distribution. Instructors can add their own slides for additional topics they introduce to the class.

**SOLUTION FILES:** Solutions to You Do It exercises and all end-of-chapter exercises are provided to instructors on the Instructor Resources CD and on the Course Technology Web site at [login.cengage.com](http://login.cengage.com). The solutions are password protected.

Annotated solutions are provided for some of the multiple-choice Review Questions. For example, if students are likely to debate answer choices, or not understand the choice deemed to be the correct one, a rationale is provided.

**DISTANCE LEARNING:** Course Technology is proud to present online test banks in WebCT and Blackboard to provide the most complete and dynamic learning experience possible. Instructors are encouraged to make the most of the course, both online and offline. For more information on how to access the online test bank, contact your local Cengage sales representative.



## Acknowledgements

I would like to thank all of the people who helped to make this book a reality, especially Dan Seiter, Development Editor. Dan's suggestions and attention to detail have improved this book over multiple editions. He is a master at ferreting out inconsistencies and has made this a superior book.

Thanks also to Alyssa Pratt, Senior Product Manager; Jill Braiewa, Senior Content Project Manager; and Chris Scriver and Serge Palladino, Quality Assurance. I am lucky to work with these professionals, who are dedicated to producing excellent instructional materials.

I am also grateful to the reviewers who provided comments and encouragement during this book's development, including Saleem Abuleil, Chicago State University; Valorie Branstool, Oklahoma State University; Robert Madison, Ivy Tech; Lori Nicholson, Wayne State College; and Susan Taylor, Mount Wachusett Community College.

Thanks, too, to my husband, Geoff, for his support. Finally, this book is dedicated to Eli Anthony Farrell-Ortiz.

*Joyce Farrell*

# Read This Before You Begin

The following information will help you as you prepare to use this textbook.

## To the User of the Data Files

To complete the steps and projects in this book, you need data files that have been created specifically for this book. Your instructor will provide the data files to you. You also can obtain the files electronically from [www.cengagebrain.com](http://www.cengagebrain.com). Find the ISBN of your title on the back cover of your book, then enter the ISBN in the search box at the top of the CengageBrain home page. You can find the data files on the product page that opens. Note that you can use a computer in your school lab or your own computer to complete the exercises in this book.

## Using Your Own Computer

To use your own computer to complete the steps and exercises, you need the following:

- **Software:** Java SE 7, available from <http://www.oracle.com/technetwork/java/index.html>. Although almost all of the examples in this book will work with earlier versions of Java, this book was created using Java 7. The book clearly points out the few cases when an example is based on Java 7 and will not work with earlier versions of Java. You also need a text editor, such as Notepad. A few exercises ask you to use a browser, such as Internet Explorer.
- **Hardware:** If you are using Windows 7, the Java Web site suggests at least 128 MB of memory and at least 98 MB of disk space. For other operating system requirements, see <http://java.com/en/download/help>.
- **Data Files:** You cannot complete all the chapters and projects in this book using your own computer unless you have the data files. You can get the data files from your instructor, or you can obtain the data files electronically from [www.cengagebrain.com](http://www.cengagebrain.com).

## Special Note

At the time of publication, both of the following URLs direct you to online Java documentation: <http://java.sun.com> and <http://www.oracle.com/technetwork/java/index.html>. For convenience, this book most frequently directs you to the shorter URL, but there is no guarantee how long it will continue to be functional. Therefore, use the longer URL if needed, or simply use a search engine to locate the current location of the official Java documentation.

# Creating Your First Java Classes

In this chapter, you will:

- ① Define basic programming terminology
- ① Describe procedural and object-oriented programming concepts
- ① Describe the features of the Java programming language
- ① Analyze a Java application that produces console output
- ① Add comments to a Java class
- ① Save, compile, run, and modify a Java application
- ① Create a Java application that produces GUI output
- ① Correct errors and find help

## Learning About Programming

A computer **program** is a set of instructions that you write to tell a computer what to do. Computers are constructed from circuitry that consists of small on/off switches, so you could create a computer program by writing something along the following lines:

```
first switch-on  
second switch-off  
third switch-off  
fourth switch-on
```

The **logic** behind a computer program determines the exact order of switches that perform the desired tasks to produce desired output. A program written in the style that refers to switch settings is written in **machine language**, which is the most basic circuitry-level language. Machine language is a **low-level programming language**, or one that corresponds closely to a computer processor's circuitry. The problems with this approach lie in keeping track of the many switches involved in programming any worthwhile task and in discovering the errant switch or switches if the program does not operate as expected. In addition, the number and location of switches vary from computer to computer, which means that you need to customize a machine language program for every type of machine on which you want the program to run.



Programmers often say that machine language consists of 1s and 0s. What they mean is that you can use 1s and 0s to represent on and off switches.

Fortunately, programming has evolved into an easier task because of the development of high-level programming languages. A **high-level programming language** allows you to use a vocabulary of reasonable terms, such as *read*, *write*, or *add*, instead of the sequences of on and off switches that perform these tasks. High-level languages also allow you to assign intuitive names to areas of computer memory, such as “hoursWorked” or “rateOfPay,” rather than having to remember the memory locations (switch numbers) of those values. Java is a high-level programming language.



In every high-level programming language, the names of memory locations cannot include spaces.

Each high-level language has its own **syntax**, or rules of the language. For example, depending on the specific high-level language, you might use the verb *print* or *write* to produce output. All languages have a specific, limited vocabulary and a specific set of rules for using that vocabulary. When you are learning a computer programming language, such as Java, C++, or Visual Basic, you really are learning the vocabulary and syntax rules for that language.

Using a programming language, programmers write a series of **program statements**, similar to English sentences, to carry out the tasks they want the program to perform. After the program statements are written, high-level language programmers use a computer program called a **compiler** or **interpreter** to translate their language statements into machine code. A compiler translates an entire program before carrying out the statement, or **executing** it,

whereas an interpreter translates one program statement at a time, executing a statement as soon as it is translated.



Program statements are also known as **commands** because they are commands to the computer such as “write this statement” or “add these two numbers.”



Whether you use a compiler or interpreter often depends on the programming language you use. For example, C++ is a compiled language, and Visual Basic is an interpreted language. Each type of translator has its supporters; programs written in compiled languages execute more quickly, whereas programs written in interpreted languages are easier to develop and debug. Java uses the best of both technologies: a compiler to translate your programming statements and an interpreter to read the compiled code line by line when the program executes (also called **at run time**).

Compilers and interpreters issue one or more error messages each time they encounter an invalid program statement—that is, a statement containing a **syntax error**, or misuse of the language. Subsequently, the programmer can correct the error and attempt another translation by compiling or interpreting the program again. Locating and repairing all syntax errors is the first part of the process of **debugging** a program—freeing the program of all errors. Figure 1-1 illustrates the steps a programmer takes while developing an executable program.

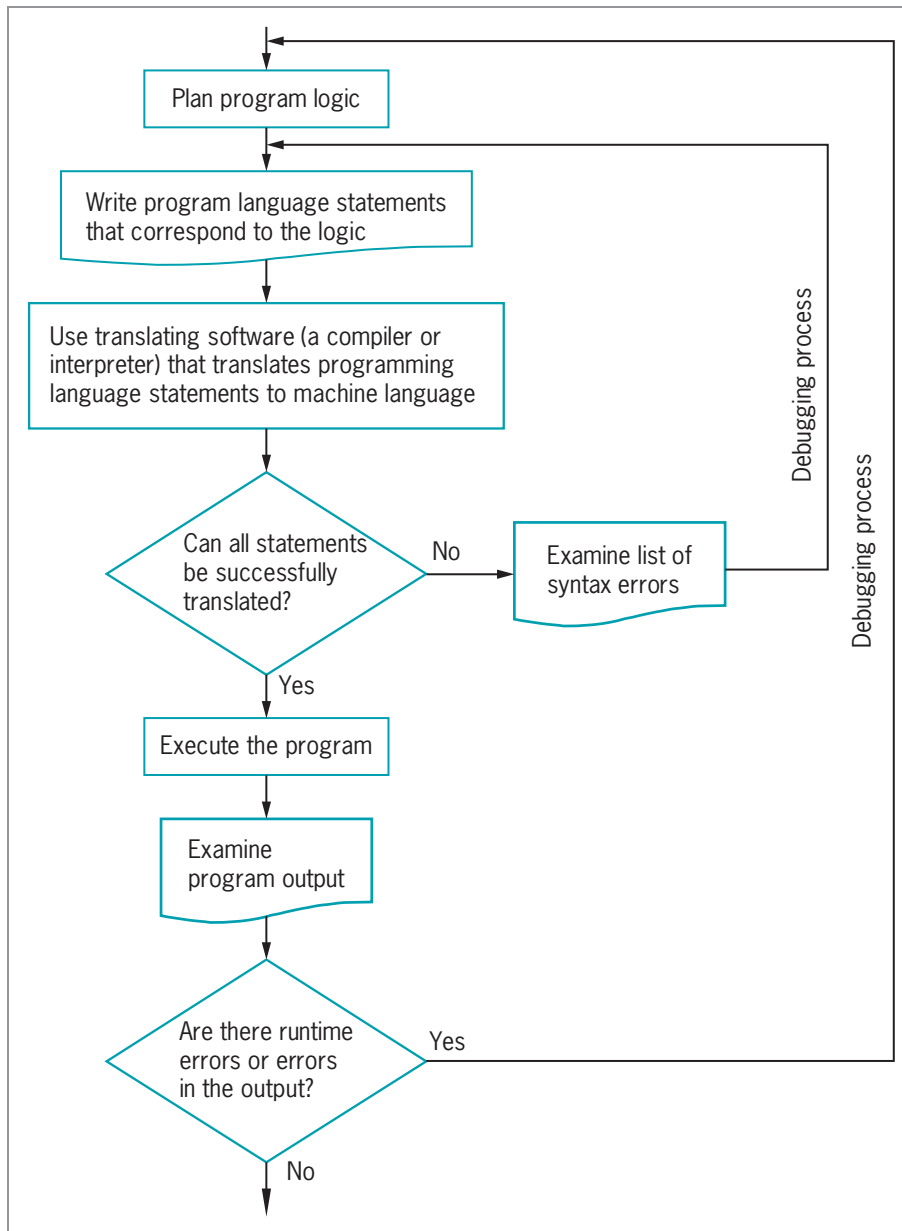


You will learn more about debugging Java programs later in this chapter.

As Figure 1-1 shows, you might be able to use a computer language’s syntax correctly, but still have errors to correct. In addition to learning the correct syntax for a particular language, a programmer must also understand computer programming logic. When you develop a program of any significant size, you should plan its logic before you write any program statements. Correct logic requires that all the right commands be issued in the appropriate order. Examples of logical errors include multiplying two values when you meant to divide them, or producing output prior to obtaining the appropriate input. Syntax errors are discovered when you compile a program, but often you can identify logical errors only when you examine a program’s first output. For example, if you know an employee’s paycheck should contain the value \$5,000, but you see that it holds \$50 or \$50,000 after you execute a payroll program, a logical error has occurred. Correcting logic errors is the second part of the debugging process. Tools that help you visualize and understand logic are presented in Chapter 5.



Programmers call some logical errors **semantic errors**. For example, if you misspell a programming-language word, you commit a syntax error, but if you use a correct word in the wrong context, you commit a semantic error.



**Figure 1-1** The program development process

## TWO TRUTHS & A LIE

### Learning About Programming

1. Unlike a low-level programming language, a high-level programming language allows you to use a vocabulary of reasonable terms instead of the sequences of on and off switches that perform the corresponding tasks.
2. A compiler executes each program statement as soon as it is translated, whereas an interpreter translates all of a program's statements before executing any.
3. A syntax error occurs when you misuse a language; locating and repairing all syntax errors is part of the process of debugging a program.

The false statement is #2. A compiler translates an entire program before carrying out any statements, whereas an interpreter translates one program statement at a time, executing a statement as soon as it is translated.

## Comparing Procedural and Object-Oriented Programming Concepts

Two popular approaches to writing computer programs are procedural programming and object-oriented programming.

### Procedural Programming

**Procedural programming** is a style of programming in which operations are executed one after another in sequence. It involves using your knowledge of a programming language to create **applications**, which are programs that perform a task for a user. In procedural applications, you create names for computer memory locations that can hold values—for example, numbers and text—in electronic form. The named computer memory locations are called **variables** because they hold values that might vary. For example, a payroll program written for a company might contain a variable named `rateOfPay`. The memory location referenced by the name `rateOfPay` might contain different values (a different value for every employee of the company) at different times. During the execution of the payroll program, each value stored under the name `rateOfPay` might have many operations performed on it—the value might be read from an input device, the value might be multiplied by another variable representing hours worked, and the value might be printed on paper. For convenience, the individual operations used in a computer program are often grouped into logical units called **procedures**. For example, a series of four or five comparisons and calculations that together determine a person's federal withholding tax value might be

grouped as a procedure named `calculateFederalWithholding`. A procedural program defines the variable memory locations and then **calls** a series of procedures to input, manipulate, and output the values stored in those locations. A single procedural program often contains hundreds of variables and thousands of procedure calls.



Procedures are also called modules, methods, functions, and subroutines. Users of different programming languages tend to use different terms. Java programmers most frequently use the term *method*.

## Object-Oriented Programming

Object-oriented programming is an extension of procedural programming in which you take a slightly different approach to writing computer programs. Writing **object-oriented programs** involves creating classes, which are blueprints for objects; creating objects from those classes; and creating applications that use those objects. After creation, classes can be reused over and over again to develop new programs. Thinking in an object-oriented manner involves envisioning program components as objects that belong to classes and that are similar to concrete objects in the real world; then, you can manipulate the objects and have them interrelate with each other to achieve a desired result.



Programmers use *OO* as an abbreviation for *object-oriented*; it is pronounced “oh oh.” Object-oriented programming is abbreviated *OOP*, and pronounced to rhyme with *soup*.

Originally, object-oriented programming was used most frequently for two major types of applications:

- **Computer simulations**, which attempt to mimic real-world activities so that their processes can be improved or so that users can better understand how the real-world processes operate
- **Graphical user interfaces**, or **GUIs** (pronounced “gooeys”), which allow users to interact with a program in a graphical environment

Thinking about objects in these two types of applications makes sense. For example, a city might want to develop a program that simulates traffic patterns to better prevent traffic tie-ups. By creating a model with objects such as cars and pedestrians that contain their own data and rules for behavior, the simulation can be set in motion. For example, each car object has a specific current speed and a procedure for changing that speed. By creating a model of city traffic using objects, a computer can create a simulation of a real city at rush hour.

Creating a GUI environment for users also is a natural use for object orientation. It is easy to think of the components a user manipulates on a computer screen, such as buttons and scroll bars, as similar to real-world objects. Each GUI object contains data—for example, a button on a screen has a specific size and color. Each object also contains behaviors—for example, each button can be clicked and reacts in a specific way when clicked. Some people consider the term *object-oriented programming* to be synonymous with GUI programming, but object-oriented programming means more. Although many GUI programs are object-oriented, one



does not imply the other. Modern businesses use object-oriented design techniques when developing all sorts of business applications, whether they are GUI applications or not.



Do not assume that all object-oriented programs are written to use GUI objects—they are not. However, the difference between command-line and GUI operating systems provides an analogy that helps you envision object-oriented concepts.

Understanding how object-oriented programming differs from traditional procedural programming requires understanding three basic concepts:

- Polymorphism
- Inheritance
- Encapsulation as it applies to classes as objects



You can remember the three concepts *polymorphism*, *inheritance*, and *encapsulation* by remembering the acronym *PIE*.

## Understanding Classes, Objects, and Encapsulation

In object-oriented terminology, a **class** is a term that describes a group or collection of objects with common properties. A **class definition** describes what attributes its objects will have and what those objects will be able to do. **Attributes** are the characteristics that define an object; they are **properties** of the object. The values contained in an object's properties differentiate objects of the same class from one another. An **object** is a specific, concrete **instance** of a class.



When you create an object instance, you **instantiate** it.

For example, the class `Automobile` describes what `Automobile` objects are like. Some properties of the `Automobile` class are `make`, `model`, `year`, and `color`. Each `Automobile` object possesses the same attributes, but not, of course, the same values for those attributes. One `Automobile` might be a 2009 white Ford Taurus and another might be a 2011 red Chevrolet Camaro. Similarly, your dog has the properties of all `Dogs`, including a breed, name, age, and whether his shots are current. The values of the properties of an object are also referred to as the object's **state**.



In object-oriented programming grammar, an object is equivalent to a noun, and an attribute is an adjective. Methods are similar to verbs.

When you understand an object's class, you understand a lot about the object. If your friend purchases an `Automobile`, you know it has a model name, and if your friend gets a `Dog`, you know the dog has a breed. Knowing what attributes exist for classes allows you to ask appropriate questions about the states or values of those attributes. Similarly, in a GUI

operating environment, you expect each component to have specific, consistent attributes and methods, such as a window having a title bar and a close button, because each component gains these properties as a member of the general class of GUI components. Figure 1-2 shows the relationship of some Dog objects to the Dog class.

8



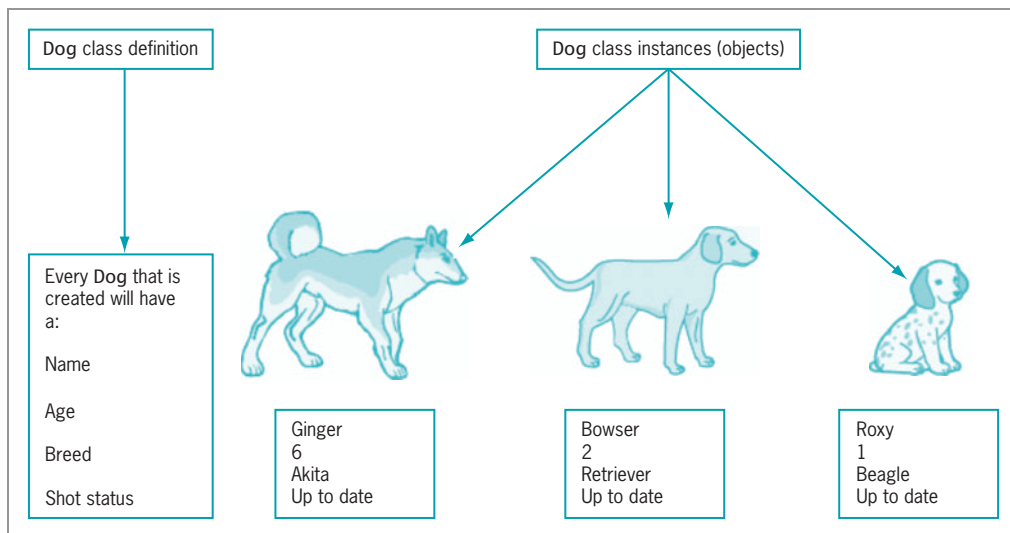
By convention, programmers using Java begin their class names with an uppercase letter. Thus, the class that defines the attributes and methods of an automobile would probably be named `Automobile`, and the class for dogs would probably be named `Dog`. However, following this convention is not required to produce a workable program.



When you learn a programming language such as Java, you learn to work with two types of classes: those that have already been developed by the language's creators and your own new, customized classes.



In the same way that a blueprint exists before any houses are built from it, and a recipe exists before any cookies are baked from it, so does a class exist before any objects are instantiated from it.



**Figure 1-2** A class definition and some objects created from it

Besides defining properties, classes define methods their objects can use. A **method** is a self-contained block of program code that carries out some action, similar to a procedure in a procedural program. An `Automobile`, for example, might have methods for moving forward, moving backward, being filled with gasoline, and being washed. Some methods can ascertain certain attributes, such as the current speed of an `Automobile` and the status of its gas tank. Similarly, a `Dog` can walk or run, eat food, and get a bath, and there are methods to determine how hungry the `Dog` is or what its name is. GUI operating system components can be maximized, minimized, and dragged.

In object-oriented classes, attributes and methods are encapsulated into objects that are then used much like real-world objects. **Encapsulation** refers to the hiding of data and methods within an object. Encapsulation provides the security that keeps data and methods safe from inadvertent changes. Programmers sometimes refer to encapsulation as using a “black box,” or a device that you can use without regard to the internal mechanisms. A programmer can access and use the methods and data contained in the black box but cannot change them.

If an object’s methods are well written, the user is unaware of the low-level details of how the methods are executed, and the user must simply understand the interface or interaction between the method and the object. For example, if you can fill your `Automobile` with gasoline, it is because you understand the interface between the gas pump nozzle and the vehicle’s gas tank opening. You don’t need to understand how the pump works mechanically or where the gas tank is located inside your vehicle. If you can read your speedometer, it does not matter how the displayed figure is calculated. As a matter of fact, if someone produces a superior, more accurate speed-determining device and inserts it in your `Automobile`, you don’t have to know or care how it operates, as long as your interface remains the same. The same principles apply to well-constructed classes used in object-oriented programs—programs that use classes only need to work with interfaces.

## Understanding Inheritance and Polymorphism

An important feature of object-oriented programs is **inheritance**—the ability to create classes that share the attributes and methods of existing classes, but with more specific features. For example, `Automobile` is a class, and all `Automobile` objects share many traits and abilities. `Convertible` is a class that inherits from the `Automobile` class; a `Convertible` is a type of `Automobile` that has and can do everything a “plain” `Automobile` does—but with an added ability to lower its top. (In turn, `Automobile` inherits from the `Vehicle` class.) `Convertible` is not an object—it is a class. A specific `Convertible` is an object—for example, `my1967BlueMustangConvertible`.



Chapters 10 and 11 provide more information about inheritance and polymorphism, and how they are implemented in Java.

Inheritance helps you understand real-world objects. For example, the first time you encounter a `Convertible`, you already understand how the ignition, brakes, door locks, and other `Automobile` systems work. You need to be concerned only with the attributes and methods that are “new” with a `Convertible`. The advantages in programming are the same—you can build new classes based on existing classes and concentrate on the specialized features you are adding.

A final important concept in object-oriented terminology is **polymorphism**. Literally, polymorphism means “many forms”—it describes the feature of languages that allows the same word or symbol to be interpreted correctly in different situations based on the context. For example, although the classes `Automobile`, `Sailboat`, and `Airplane` all inherit from `Vehicle`, `turn` and `stop` methods work differently for instances of those classes. The advantages of polymorphism will become more apparent when you begin to create GUI

applications containing features such as windows, buttons, and menu bars. In a GUI application, it is convenient to remember one method name, such as `setColor` or `setHeight`, and have it work correctly no matter what type of object you are modifying.

10



Watch the video *Object-Oriented Programming*.



When you see a plus sign (+) between two numbers, you understand they are being added. When you see it carved in a tree between two names, you understand that the names are linked romantically. Because the symbol has diverse meanings based on context, it is polymorphic.

## TWO TRUTHS & A LIE

### Comparing Procedural and Object-Oriented Programming Concepts

1. An instance of a class is a created object that possesses the attributes and methods described in the class definition.
2. Encapsulation protects data by hiding it within an object.
3. Polymorphism is the ability to create classes that share the attributes and methods of existing classes, but with more specific features.

The false statement is #3. Inheritance is the ability to create classes that share the attributes and methods of existing classes, but with more specific features; polymorphism describes the ability to use one term to cause multiple actions.

## Features of the Java Programming Language

**Java** was developed by Sun Microsystems as an object-oriented language for general-purpose business applications and for interactive, World Wide Web-based Internet applications. Some of the advantages that have made Java so popular in recent years are its security features and the fact that it is **architecturally neutral**, which means that you can use Java to write a program that runs on any platform (operating system).

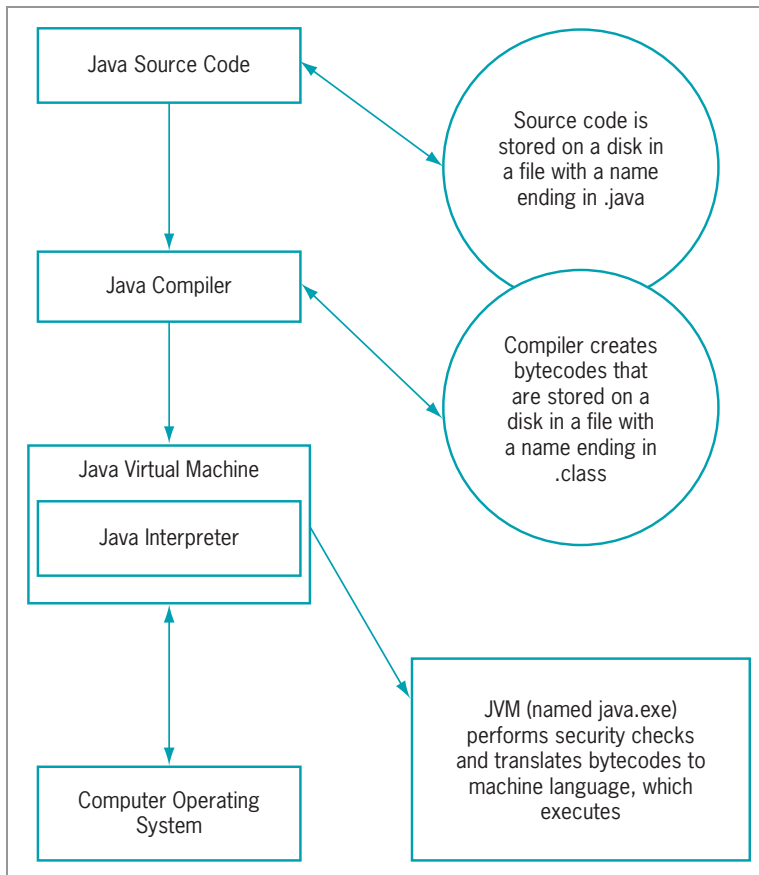
Java can be run on a wide variety of computers because it does not execute instructions on a computer directly. Instead, Java runs on a hypothetical computer known as the **Java Virtual Machine (JVM)**.



When programmers call the JVM “hypothetical,” they don’t mean it doesn’t exist. Instead, they mean it is not a physical entity created from hardware, but is composed only of software.

**Interactive applications** are those in which a user communicates with a program by using an input device such as the keyboard or a mouse.

Figure 1-3 shows the Java environment. Programming statements written in a high-level programming language are called **source code**. When you write a Java program, you first construct the source code using a text editor such as Notepad. The statements are saved in a file; then, the Java compiler converts the source code into a binary program of **bytecode**. A program called the **Java interpreter** then checks the bytecode and communicates with the



**Figure 1-3** The Java environment

operating system, executing the bytecode instructions line by line within the Java Virtual Machine. Because the Java program is isolated from the operating system, the Java program also is insulated from the particular hardware on which it is run. Because of this insulation, the JVM provides security against intruders accessing your computer's hardware through the operating system. Therefore, Java is more secure than other languages. Another advantage provided by the JVM means less work for programmers—when using other programming languages, software vendors usually have to produce multiple versions of the same product (a Windows version, Macintosh version, UNIX version, Linux version, and so on) so all users can run the program. With Java, one program version will run on all these platforms.



**“Write once, run anywhere” (WORA)** is a slogan developed by Sun Microsystems to describe the ability of one Java program version to work correctly on multiple platforms.

Java also is simpler to use than many other object-oriented languages. Java is modeled after C++. Although neither language is easy to read or understand on first exposure, Java does eliminate some of the most difficult-to-understand features in C++, such as pointers and multiple inheritance.

## Java Program Types

You can write two kinds of programs using Java. Programs that are embedded in a Web page are called Java **applets**. Stand-alone programs are called **Java applications**. Java applications can be further subdivided into **console applications**, which support character output to a computer screen in a DOS window, for example, and **windowed applications**, which create a GUI with elements such as menus, toolbars, and dialog boxes. Console applications are the easiest applications to create; you start using them in the next section.

### TWO TRUTHS & A LIE

#### Features of the Java Programming Language

1. Java was developed to be architecturally neutral, which means that anyone can build an application without extensive study.
2. After you write a Java program, the compiler converts the source code into a binary program of bytecode.
3. Java programs that are embedded in a Web page are called applets, while stand-alone programs are called Java applications.

The false statement is #1. Java was developed to be architecturally neutral, which means that you can use Java to write a program that will run on any platform.

## Analyzing a Java Application that Produces Console Output

At first glance, even the simplest Java application involves a fair amount of confusing syntax. Consider the application in Figure 1-4. This program is written on seven lines, and its only task is to display “First Java application” on the screen.

13

```
public class First
{
    public static void main(String[] args)
    {
        System.out.println("First Java application");
    }
}
```

**Figure 1-4** The First class



When you see program code in figures in this book, Java keywords as well as `true`, `false`, and `null` are blue, and all other program elements are black. A complete list of Java keywords is shown later in this chapter.



The code for every complete program shown in this book is available in a set of student files you can download so that you can execute the programs on your own computer.

### Understanding the Statement that Produces the Output

The statement `System.out.println("First Java application");` does the actual work in this program. Like all Java statements, this one ends with a semicolon.

The text “First Java application” is a **literal string** of characters; that is, it is a series of characters that will appear in output exactly as entered. Any literal string in Java is written between double quotation marks. Figure 1-5 labels this string and the other parts of the statement.



Most Java programming statements can be written on as many lines as you choose, as long as you place line breaks between words. However, a literal string cannot be broken and placed on multiple lines.



A statement does not necessarily end at the end of a line; a statement might run across several lines until it ends with a semicolon.

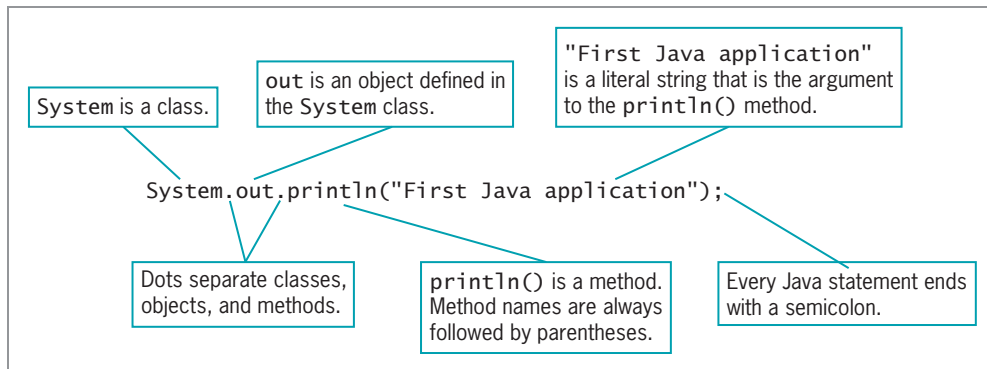


Figure 1-5 Anatomy of a Java statement



The dots (periods) in `System.out.println` are used to separate the names of the components in the statement. You will use this same format repeatedly in your Java programs.

The string “First Java application” appears within parentheses because the string is an argument to a method, and arguments to methods always appear within parentheses. **Arguments** are pieces of information that are sent into, or **passed** to, a method, usually because the method requires the information to perform its task or carry out its purpose. As an example, consider placing a catalog order with a company that sells sporting goods. Processing a catalog order is a method that consists of a set of standard procedures—recording the order, checking the availability of the item, pulling the item from the warehouse, and so on. Each catalog order also requires a set of data items, such as which item number you are ordering and the quantity of the item desired; these data items can be considered the order’s arguments. If you order two of item 5432 from a catalog, you expect different results than if you order 1,000 of item 9008. Likewise, if you pass the argument “Happy Holidays” to a Java method, you expect different results than if you pass the argument “First Java application”.



When you call a method, you always use parentheses following the method name. In this book you will learn about many methods that require arguments between their parentheses, and many others for which you leave the parentheses empty.



The `println()` method requires only one argument. Later in this chapter, you will learn about a method named `showMessageDialog()` that requires two arguments. Other methods require more.



You can use the `println()` method with no arguments when you want to output a blank line.



Within the statement `System.out.println("First Java application");`, the method to which you are passing "First Java application" is named `println()`. The `println()` method displays a line of output on the screen and positions the insertion point on the next line, so that any subsequent output appears on a new line.



Method names usually are referenced followed by their parentheses, as in `println()`, so that you can distinguish method names from variable names.

Within the statement `System.out.println("First Java application");`, `out` is a property of the `System` class that refers to the **standard output device** for a system, normally the monitor. The `out` object itself is an instance of the `PrintStream` class, which contains several methods, including `println()`. Technically, you could create the `out` object and write the instructions within the `println()` method yourself, but it would be time consuming, and the creators of Java assumed you frequently would want to display output on a screen. Therefore, the `System` and `PrintStream` classes, the `out` object, and the `println()` method were created as a convenience to the programmer.



The `print()` method is very similar to the `println()` method. With `println()`, after the message is displayed, the insertion point appears on the following line. With `print()`, the insertion point does not advance to a new line; it remains on the same line as the output.

Within the statement `System.out.println("First Java application");`, `System` is a class. Therefore, `System` defines attributes for `System` objects, just as the `Dog` class defines the attributes for `Dog` objects. One of the `System` attributes is `out`. (You can probably guess that another attribute is `in` and that it represents an input device.)



Java is case sensitive; the class named `System` is a completely different class from one named `system`, `SYSTEM`, or even `sYsTeM`.

The statement that displays the string "First Java application" cannot stand alone; it is embedded within a class, as shown in Figure 1-4.

## Understanding the First Class

Everything that you use within a Java program must be part of a class. When you write `public class First`, you are defining a class named `First`. You can define a Java class using any name or **identifier** you need, as long as it meets the following requirements:

- A Java identifier must begin with a letter of the English alphabet, a non-English letter (such as  $\alpha$  or  $\pi$ ), an underscore, or a dollar sign. A class name cannot begin with a digit.
- A Java identifier can contain only letters, digits, underscores, or dollar signs.



Java is based on **Unicode**, which is an international system of character representation. The term *letter* indicates English-language letters as well as characters from Arabic, Greek, and other alphabets. You can learn more about Unicode in Appendix B.

- A Java identifier cannot be a reserved keyword, such as `public` or `class`. (See Table 1-1 for a list of reserved keywords.)
- A Java identifier cannot be one of the following values: `true`, `false`, or `null`. These are not keywords (they are primitive values), but they are reserved and cannot be used.

<code>abstract</code>	<code>continue</code>	<code>for</code>	<code>new</code>	<code>switch</code>
<code>assert</code>	<code>default</code>	<code>goto</code>	<code>package</code>	<code>synchronized</code>
<code>boolean</code>	<code>do</code>	<code>if</code>	<code>private</code>	<code>this</code>
<code>break</code>	<code>double</code>	<code>implements</code>	<code>protected</code>	<code>throw</code>
<code>byte</code>	<code>else</code>	<code>import</code>	<code>public</code>	<code>throws</code>
<code>case</code>	<code>enum</code>	<code>instanceof</code>	<code>return</code>	<code>transient</code>
<code>catch</code>	<code>extends</code>	<code>int</code>	<code>short</code>	<code>try</code>
<code>char</code>	<code>final</code>	<code>interface</code>	<code>static</code>	<code>void</code>
<code>class</code>	<code>finally</code>	<code>long</code>	<code>strictfp</code>	<code>volatile</code>
<code>const</code>	<code>float</code>	<code>native</code>	<code>super</code>	<code>while</code>

**Table 1-1** Java reserved keywords



Although they are reserved as keywords, `const` and `goto` are not used in Java programs and they have no function. Both words are used in other languages and were reserved in case developers of future versions of Java wanted to implement them.

It is a Java standard, although not a requirement, to begin class identifiers with an uppercase letter and employ other uppercase letters as needed to improve readability. Table 1-2 lists some valid and conventional class names that you could use when writing programs in Java. Table 1-3 provides some examples of class names that *could* be used in Java (if you use these class names, the class will compile) but that are unconventional and not recommended. Table 1-4 provides some class name examples that are illegal.

<b>Class Name</b>	<b>Description</b>
<code>Employee</code>	Begins with an uppercase letter
<code>UnderGradStudent</code>	Begins with an uppercase letter, contains no spaces, and emphasizes each new word with an initial uppercase letter
<code>InventoryItem</code>	Begins with an uppercase letter, contains no spaces, and emphasizes the second word with an initial uppercase letter
<code>Budget2012</code>	Begins with an uppercase letter and contains no spaces

**Table 1-2** Some valid class names in Java



You should follow established conventions for Java so your programs will be easy for other programmers to interpret and follow. This book uses established Java programming conventions.

Using an uppercase letter to begin an identifier and to start each new word in an identifier is known as **Pascal casing**.

Class Name	Description
Undergradstudent	New words are not indicated with initial uppercase letters, making this identifier difficult to read
Inventory_Item	Underscore is not commonly used to indicate new words
BUDGET2012	Using all uppercase letters for class identifiers is not conventional
budget2012	Conventionally, class names do not begin with a lowercase letter

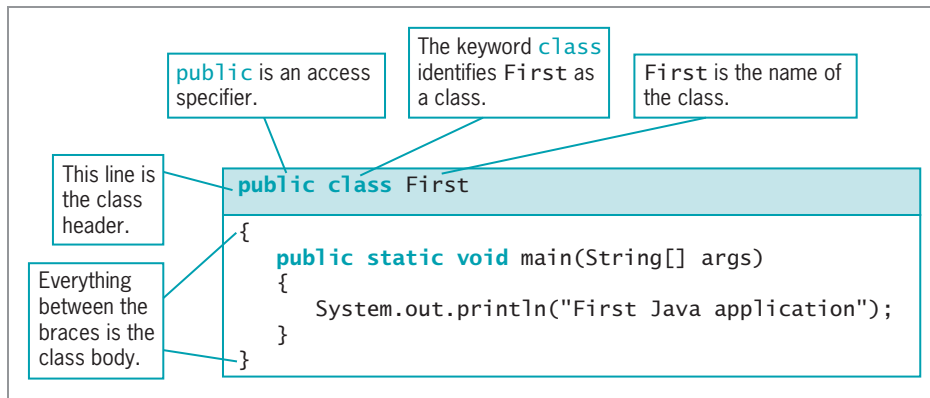
**Table 1-3** Legal but unconventional and nonrecommended class names in Java

Class Name	Description
Inventory Item	Space character is illegal in an identifier
c1ass	c1ass is a reserved word
2012Budget	Class names cannot begin with a digit
phone#	The number symbol ( # ) is illegal in an identifier

**Table 1-4** Some illegal class names in Java

In Figure 1-4 (and again in Figure 1-6), the line `public class First` is the class header; it contains the keyword `class`, which identifies `First` as a class. The reserved word `public` is an access specifier. An **access specifier** defines the circumstances under which a class can be accessed and the other classes that have the right to use a class. Public access is the most liberal type of access; you will learn about public and other types of access in Chapter 3.

After the class header, you enclose the contents of a class within curly braces ( `{` and `}` ); any data items and methods between the curly braces make up the **class body**. A class body can be composed of any number of data items and methods. In Figure 1-4 (and again in Figure 1-6), the class `First` contains only one method within its curly braces. The name of the method is `main()`, and the `main()` method, like the `println()` method, includes its own set of parentheses. The `main()` method in the `First` class contains only one statement—the statement that uses the `println()` method.



**Figure 1-6** The parts of a typical class



The `First` class contains one method named `main()`. The `main()` method does not contain any other methods, but it does contain a *method call* to the `println()` method.



In general, whitespace is optional in Java. **Whitespace** is any combination of nonprinting characters—for example, spaces, tabs, and carriage returns (blank lines). However, you cannot use whitespace within any identifier or keyword. You can insert whitespace between words or lines in your program code by typing spaces, tabs, or blank lines because the compiler ignores these extra spaces. You use whitespace to organize your program code and make it easier to read.

## Indent Style

For every opening curly brace ( `{` ) in a Java program, there must be a corresponding closing curly brace ( `}` ). The placement of the opening and closing curly braces is not important to the compiler. For example, the following class executes in exactly the same way as the one shown in Figure 1-4. The only difference is the layout of the braces—the line breaks occur in different locations.

```
public class First{
    public static void main(String[] args){
        System.out.println("First Java application");
    }
}
```



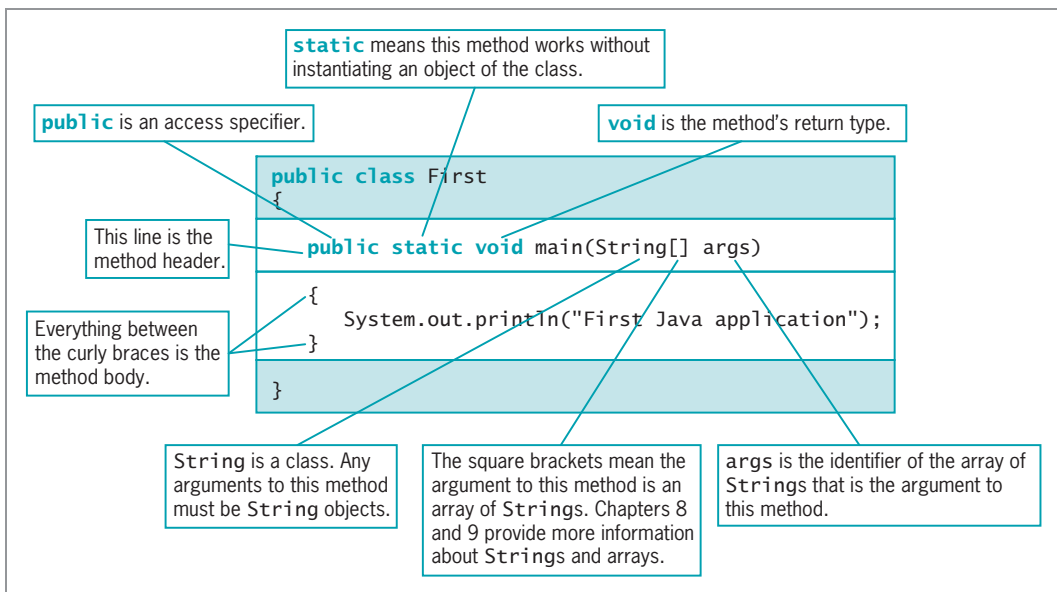
The indent style in which curly braces are aligned and each occupies its own line is called the **Allman style**, named for Eric Allman, a programmer who popularized the style. The indent style in which opening braces are not on separate lines is known as the **K & R style**, named for Kernighan and Ritchie, who wrote the first book on the C programming language.

Java programmers use a variety of indent styles, and all can produce workable Java programs. When you write your own code, you should develop a consistent style. In school, your instructor might have a preferred style, and when you get a job as a Java programmer, your organization most likely will have a preferred style.

## Understanding the `main()` Method

The method header for the `main()` method is quite complex. The meaning and purpose of each of the terms used in the method header will become clearer as you complete this textbook; a brief explanation will suffice for now.

In the method header `public static void main(String[] args)`, the word `public` is an access specifier, just as it is when you use it to define the `First` class. In Java, the reserved keyword **`static`** means that a method is accessible and usable even though no objects of the class exist. Figure 1-7 shows the parts of the `main()` method.



**Figure 1-7** The parts of a typical `main()` method

In English, the word *void* means empty. When the keyword `void` is used in the `main()` method header, it does not indicate that the `main()` method is empty, but rather that the `main()` method does not return any value when it is called. This doesn't mean that `main()` doesn't produce output—in fact, the method in Figure 1-4 (and in Figure 1-7) does. It only means that the `main()` method does not send any value back to any other method that might use it. You will learn more about return values in Chapter 3.

Not all classes have a `main()` method; in fact, many do not. All Java *applications*, however, must include a class containing a public method named `main()`, and most Java applications have additional classes and methods. When you execute a Java application, the JVM always executes the `main()` method first.

20

In the method header `public static void main(String[] args)`, the contents between the parentheses, `(String[] args)`, represent the type of argument that can be passed to the `main()` method, just as the string "First Java application" is an argument passed to the `println()` method. `String` is a Java class that can be used to hold character strings. The identifier `args` is used to hold any `String` objects that might be sent to the `main()` method. The `main()` method could do something with those arguments, such as display them, but in Figure 1-4, the `main()` method does not actually use the `args` identifier. Nevertheless, you must place an identifier within the `main()` method's parentheses. The identifier does not need to be named `args`—it could be any legal Java identifier—but the name `args` is traditional.



You won't pass any arguments to the `main()` method in this book, but when you run a program, you could. Even though you pass no arguments, the `main()` method must contain `String[]` and a legal identifier (such as `args`) within its parentheses.



When you refer to the `String` class in the `main()` method header, the square brackets indicate an array of `String` objects. You will learn more about the `String` class and arrays in Chapters 7, 8, and 9.

The simple application shown in Figure 1-4 has many pieces to remember. However, for now you can use the Java code shown in Figure 1-8 as a shell, in which you replace `AnyClassName` with a class name you choose and the line `/* */` with any statements that you want to execute.



Watch the video *A Java Program*.

```
public class AnyClassName
{
    public static void main(String[] args)
    {
        /* */
    }
}
```

Figure 1-8 Shell code

## TWO TRUTHS & A LIE

### Analyzing a Java Application that Produces Console Output

1. In the method header `public static void main(String[] args)`, the word `public` is an access specifier.
2. In the method header `public static void main(String[] args)`, the word `static` means that a method is accessible and usable, even though no objects of the class exist.
3. In the method header `public static void main(String[] args)`, the word `void` means that the `main()` method is an empty method.

The false statement is #3. In the method header `public static void main(String[] args)`, the word `void` means that the `main()` method does not return any value when it is called.

## Adding Comments to a Java Class

As you can see, even the simplest Java class requires several lines of code and contains somewhat perplexing syntax. Large applications that perform many tasks include much more code, and as you write larger applications it becomes increasingly difficult to remember why you included steps or how you intended to use particular variables. Documenting your program code helps you remember why you wrote lines of code the way you did. **Program comments** are nonexecuting statements that you add to a program for the purpose of documentation. Programmers use comments to leave notes for themselves and for others who might read their programs in the future. At the very least, your Java class files should include comments indicating the author, the date, and the class name or function. The best practice dictates that you also include a brief comment to describe the purpose of each method you create within a class.



As you work through this book, add comments as the first three lines of every file. The comments should contain the class name and purpose, your name, and the date. Your instructor might ask you to include additional comments.

Comments also can be useful when you are developing an application. If a program is not performing as expected, you can “comment out” various statements and subsequently run the program to observe the effect. When you **comment out** a statement, you turn it into a comment so the compiler does not translate it, and the JVM does not execute its command. This can help you pinpoint the location of errant statements in malfunctioning programs.

There are three types of comments in Java:

- **Line comments** start with two forward slashes ( // ) and continue to the end of the current line. A line comment can appear on a line by itself or at the end (and to the right) of a line following executable code. Line comments do not require an ending symbol.
- **Block comments** start with a forward slash and an asterisk ( /\* ) and end with an asterisk and a forward slash ( \*/ ). A block comment can appear on a line by itself, on a line before executable code, or on a line after executable code. Block comments also can extend across as many lines as needed.
- **Javadoc** comments are a special case of block comments. They begin with a forward slash and two asterisks ( /\*\* ) and end with an asterisk and a forward slash ( \*/ ). You can use javadoc comments to generate documentation with a program named javadoc. Appendix E teaches you how to create javadoc comments.



The forward slash ( / ) and the backslash ( \ ) characters often are confused, but they are two distinct characters. You cannot use them interchangeably.

The Java Development Kit (JDK) includes the javadoc tool, which you can use when writing programs in Java. The tool produces HTML pages that describe classes and their contents.

Figure 1-9 shows how comments are used in code. In this example, the only statement that executes is the `System.out.println("Hello");` statement; everything else (all the shaded parts) is a comment.

```
// Demonstrating comments
/* This shows
   that these comments
   don't matter */
System.out.println("Hello"); // This line executes
// up to where the comment started
/* Everything but the println()
   is a comment */
```

**Figure 1-9** A program segment containing several comments



**TWO TRUTHS & A LIE****Adding Comments to a Java Class**

1. Line comments start with two forward slashes ( // ) and end with two backslashes ( // ); they can extend across as many lines as needed.
2. Block comments start with a forward slash and an asterisk ( /\* ) and end with an asterisk and a forward slash ( \*/ ); they can extend across as many lines as needed.
3. Javadoc comments begin with a forward slash and two asterisks ( /\*\* ) and end with an asterisk and a forward slash ( \*/ ); they are used to generate documentation with a program named javadoc.

The false statement is #1. Line comments start with two forward slashes ( // ) and continue to the end of the current line; they do not require an ending symbol.

## Saving, Compiling, Running, and Modifying a Java Application

### Saving a Java Class

When you write a Java class, you must save it using a storage medium such as a disk, DVD, or USB device. In Java, if a class is `public` (that is, if you use the `public` access specifier before the class name), you must save the class in a file with exactly the same name and a `.java` extension. For example, the `First` class must be stored in a file named `First.java`. The class name and filename must match exactly, including the use of uppercase and lowercase characters. If the extension is not `.java`, the Java compiler does not recognize the file as containing a Java class.



Appendix A contains important information on saving, compiling, and running a Java application.

### Compiling a Java Class

After you write and save an application, two steps must occur before you can view the application's output.

1. You must compile the class you wrote (called the source code) into bytecode.
2. You must use the Java interpreter to translate the bytecode into executable statements.

To compile your source code from the command line, your prompt should show the folder or directory where your program file is stored. Then, you type `javac` followed by the name of the file that contains the source code. For example, to compile a file named `First.java`, you type the following and then press Enter:

```
javac First.java
```

There will be one of three outcomes:

- You receive a message such as `'javac' is not recognized as an internal or external command, operable program or batch file.`
- You receive one or more program language error messages.
- You receive no messages, which means that the application compiled successfully.



When compiling, if the source code file is not in the current path, you can type a full path with the filename. For example:

```
javac c:\java\MyClasses\Chapter.01\First.java
```



In a DOS environment, you can change directories using the `cd` command. For example, to change from the current directory to a subdirectory named `MyClasses`, you type `cd MyClasses` and press Enter. Within any directory, you can back up to the root directory by typing `cd\` and pressing Enter.

If you receive an error message that the command is not recognized, it might mean one of the following:

- You misspelled the command `javac`.
- You misspelled the filename.
- You are not within the correct subfolder or subdirectory on your command line.
- Java was not installed properly. (See Appendix A for information on installation.)

If you receive a programming language error message, there are one or more syntax errors in the source code. Recall that a syntax error is a programming error that occurs when you introduce typing errors into your program or use the programming language incorrectly. For example, if your class name is `first` (with a lowercase `f`) in the source code but you saved the file as `First.java` (with an uppercase `F`), when you compile the application you'll receive an error message, such as `class first is public, should be declared in a file named first.java`, because `first` and `First` are not the same in a case-sensitive language. If this error occurs, you must reopen the text file that contains the source code and make the necessary corrections.



Appendix A contains information on troubleshooting, including how to change filenames in a Windows environment.

If you receive no error messages after compiling the code in a file named `First.java`, the application compiled successfully, and a file named `First.class` is created and saved in the same

folder as the application text file. After a successful compile, you can run the class file on any computer that has a Java language interpreter.

## Running a Java Application

To run the `First` application from the command line, you type the following:

```
java First
```

Figure 1-10 shows the application's output in the command window. In this example, you can see that the `First` class is stored in a folder named `Java` on the `C` drive.



The procedure to confirm the storage location of your `First.java` class varies depending on your operating system. In a Windows operating system, for example, you can open Windows Explorer, locate the icon representing the storage device you are using, find the folder in which you have saved the file, and expand the folder. You should see the `First.java` file.



Once in a while, when you make a change to a Java class and then recompile and execute it, the old version still runs. The simplest solution is to delete the `.class` file and compile again. Programmers call this creating a **clean build**.



**Figure 1-10** Output of the `First` application

## Modifying a Java Class

After viewing the application output, you might decide to modify the class to get a different result. For example, you might decide to change the `First` application's output from `First Java application` to the following:

```
My new and improved  
Java application
```

To produce the new output, first you must modify the text file that contains the existing class. You need to change the existing literal string, and then add an output statement for another text string. Figure 1-11 shows the class that changes the output.

```
public class First
{
    public static void main(String[] args)
    {
        System.out.println("My new and improved");
        System.out.println("Java application");
    }
}
```

**Figure 1-11** First class containing modified output from original version

The changes to the `First` class include the addition of the statement `System.out.println("My new and improved");` and the removal of the word `First` from the string in the other `println()` statement. However, if you make changes to the file as shown in Figure 1-11, save the file, and execute the program by typing `java First` at the command line, you will not see the new output—you will see the old output without the added line. Even though you save a text file containing the modified source code for a class, it is the compiled class in the already-compiled class file that executes. After you save the file named `First.java`, the old compiled version of the class with the same name is still stored on your computer. Before the new source code will execute, you must do the following:

1. Save the file with the changes (using the same filename).
2. Compile the class with the `javac` command. (Actually, you are recompiling the class.)
3. Interpret the class bytecode and execute the class using the `java` command.



**Figure 1-12** Execution of modified `First` class

Figure 1-12 shows the new output.



Watch the video *Compiling and Executing a Program*.



When you complete these steps, the original version of the compiled file with the `.class` extension is replaced, and the new application executes. The original version no longer exists. When you modify a class, you must decide whether you want to retain the original version. If you do, you must give the new version a new class and filename.

## TWO TRUTHS & A LIE

### Saving, Compiling, Running, and Modifying a Java Application

1. In Java, if a class is `public`, you must save the class in a file with exactly the same name and a `.java` extension.
2. To compile a file named `MyProgram.java`, you type `java MyProgram`, but to execute the program you type `java MyProgram.java`.
3. A syntax error is a programming error that occurs when you introduce typing errors into your program or use the programming language incorrectly; a program will not compile with syntax errors.

The false statement is #2. To compile a file named `MyProgram.java`, you type `javac MyProgram.java`, but to execute the program you type `java MyProgram`.

27

## Creating a Java Application that Produces GUI Output

Besides allowing you to use the `System` class to produce command window output, Java provides built-in classes that produce GUI output. For example, Java contains a class named `JOptionPane` that allows you to produce dialog boxes. A **dialog box** is a GUI object resembling a window in which you can place messages you want to display. Figure 1-13 shows a class named `FirstDialog`. The `FirstDialog` class contains many elements that are familiar to you; only the two shaded lines are new.

```
import javax.swing.JOptionPane;
public class FirstDialog
{
    public static void main(String[] args)
    {
        JOptionPane.showMessageDialog(null, "First Java dialog");
    }
}
```

**Figure 1-13** The `FirstDialog` class



In older versions of Java, any application that used a `JOptionPane` dialog was required to end with a `System.exit(0)`; statement or the application would not terminate. You can add this statement to your programs, and they will work correctly, but it is not necessary.

In Figure 1-13, the first shaded line is an `import` statement. You use an **import statement** when you want to access a built-in Java class that is contained in a group of classes called a **package**. To use the `JOptionPane` class, you must import the package named `javax.swing.JOptionPane`.

28



Any `import` statement you use must be placed outside of any class you write in a file. You will learn more about `import` statements in general, and the `javax.swing` packages in particular, as you continue to study Java.



You do not need to use an `import` statement when you use the `System` class (as with the `System.out.println()` method) because the `System` class is contained in the package `java.lang`, which is automatically imported in every Java program. You *could* include the statement `import java.lang;` at the top of any file in which you use the `System` class, but you are not required to do so.

The second shaded statement in the `FirstDialog` class in Figure 1-13 uses the `showMessageDialog()` method that is part of the `JOptionPane` class. Like the `println()` method that is used for console output, the `showMessageDialog()` method is followed by a set of parentheses. However, whereas the `println()` method requires only one argument between its parentheses to produce an output string, the `showMessageDialog()` method requires two arguments. When the first argument to `showMessageDialog()` is `null`, as it is in the class in Figure 1-13, it means the output message box should be placed in the center of the screen. The second argument, after the comma, is the string that is displayed.



Earlier in this chapter, you learned that `true`, `false`, and `null` are all reserved words that represent values.



You will learn more about dialog boxes, including how to position them in different locations and how to add more options to them, in Chapter 2.



Whenever a method requires multiple arguments, the arguments are always separated with commas.

When a user executes the `FirstDialog` class, the dialog box in Figure 1-14 is displayed. The user must click the OK button or the Close button to dismiss the dialog box.



**Figure 1-14** Output of the `FirstDialog` application

## TWO TRUTHS & A LIE

### Creating a Java Application that Produces GUI Output

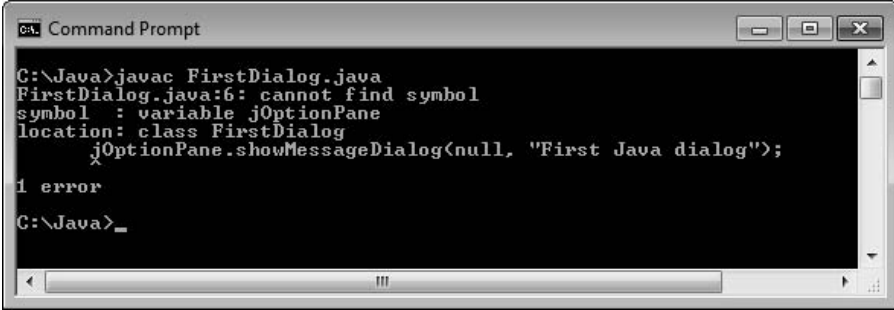
1. A dialog box is a GUI object resembling a window in which you can place messages you want to display.
2. You use an `append` statement when you want to access a built-in Java class that is contained in a group of classes called a package.
3. Different methods can require different numbers of arguments.

The false statement is #2. You use an `import` statement when you want to access a built-in Java class that is contained in a group of classes called a package.

## Correcting Errors and Finding Help

Frequently, you might make typing errors as you enter Java statements into your text editor. When you issue the command to compile the class containing errors, the Java compiler produces one or more error messages. The exact error message that appears varies depending on the compiler you are using. In the `FirstDialog` class (shown in Figure 1-13), if you mistype the `JOptionPane` code in the sixth line using a lowercase `j` in `JOptionPane`, an error message similar to the one shown in Figure 1-15 is displayed. The first line of the error message displays the name of the file in which the error was found (`FirstDialog.java`), the line number in which it was found (6), and the nature of the error (“cannot find symbol”). The next two lines identify the symbol that cannot be found (`jOptionPane`) and the name of the class (`FirstDialog`). The last line of the error message displays the line with the error, including a caret that points to the exact location where the error was first discovered. Then a count of the number of errors is displayed—in this case, there is just one error.

This is a **compile-time error**, or one in which the compiler detects a violation of language syntax rules and is unable to translate the source code to machine code.



```
C:\Java>javac FirstDialog.java
FirstDialog.java:6: cannot find symbol
symbol : variable JOptionPane
location: class FirstDialog
    JOptionPane.showMessageDialog(null, "First Java dialog");
1 error
C:\Java>_
```

**Figure 1-15** Error message generated when program contains case error

When you compile a class, the compiler reports as many errors as it can find so that you can fix as many errors as possible. Sometimes, one error in syntax causes multiple error messages that normally would not be errors if the first syntax error did not exist. Consider the `ErrorTest` class shown in Figure 1-16. The class contains a single error—the comment that starts in the second line is never closed. However, when you attempt to compile this class, you receive two error messages, as shown in Figure 1-17.

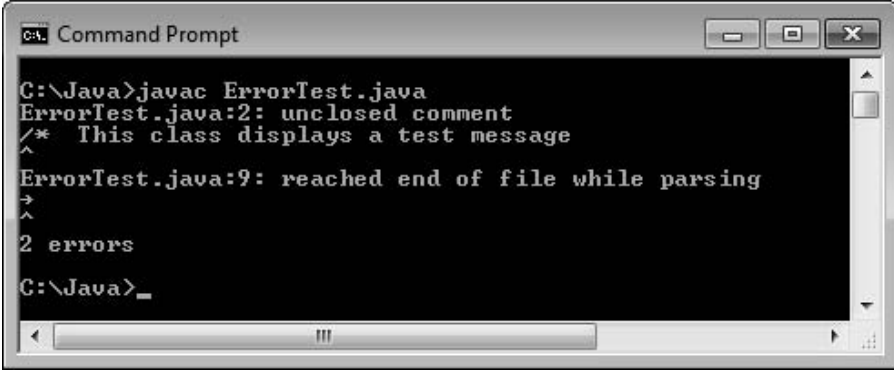
```
public class ErrorTest
/* This class displays a test message
{
    public static void main(String[] args)
    {
        System.out.println("Test");
    }
}
```

**Figure 1-16** The `ErrorTest` class with an unclosed comment

The first error message in Figure 1-17 correctly identifies the unclosed comment. The second error message is more confusing: “reached end of file while parsing.” **Parsing** is the process the compiler uses to divide your source code into meaningful portions; the message means that the compiler was in the process of analyzing the code when the end of the file was encountered prematurely. If you repair the first error by closing off the comment and then save and recompile the class, both error messages disappear. The second message is generated only as a side effect of the unfinished comment. When you compile a class and view a list of errors, correct the errors that make sense to you and then recompile. Sometimes, when you correct an error or two, several others disappear. On the other hand, sometimes when you fix a compile-time error and recompile a program, new error messages are generated. That’s



because when you fix the first error, the compiler can proceed beyond that point and possibly discover new errors. Of course, no programmer intends to type a program containing syntax errors, but when you do, the compiler finds them all for you.



```

C:\Java>javac ErrorTest.java
ErrorTest.java:2: unclosed comment
/* This class displays a test message
^
ErrorTest.java:9: reached end of file while parsing
^
2 errors
C:\Java>_

```

**Figure 1-17** Error messages generated by ErrorTest application in Figure 1-16



You also will receive the error message “reached end of file while parsing” if you omit a program’s closing curly brace.

A second kind of error occurs when the syntax of the program is correct and the program compiles but produces incorrect results when you execute it. This type of error is a **logic error**, which is usually more difficult to find and resolve. In the `ErrorTest` class in Figure 1-16, typing the executable statement as `System.out.println("Tst");` does not produce an error. The compiler does not find the spelling error of `Tst` instead of `Test`; the code is compiled and the JVM can execute the statements. Other examples of logic errors include multiplying two values when you meant to add, printing one copy of a report when you meant to print five, or forgetting to produce a requested count of the number of times an event has occurred. Errors of this type must be detected by carefully examining the program output. It is the responsibility of the program author to test programs and find any logic errors. Good programming practice emphasizes programming structure and development that helps minimize errors. In addition, each chapter in this book contains four exercises in which you get the opportunity to locate and correct syntax and logic errors. Programmers call the process of correcting all these errors “debugging” a program.



A logic error is a type of **run-time error**—an error not detected until the program asks the computer to do something wrong, or even illegal, while executing.



The process of fixing computer errors has been known as debugging since a large moth was found wedged into the circuitry of a mainframe computer at Harvard University in 1945. See these Web sites for interesting details and pictures: [www.jameshuggins.com/h/tek1/first\\_computer\\_bug.htm](http://www.jameshuggins.com/h/tek1/first_computer_bug.htm) and [www.history.navy.mil/photos/images/h96000/h96566kc.htm](http://www.history.navy.mil/photos/images/h96000/h96566kc.htm).

As you write Java programs, you can frequently consult this book as well as other Java documentation. A great wealth of helpful material exists at the Sun Microsystems Web site, <http://java.sun.com>. Of particular value is the Java application programming interface, more commonly referred to as the **Java API**. The Java API is also called the Java class library; it contains information about how to use every prewritten Java class, including lists of all the methods you can use with the classes.

Also of interest at the [java.sun.com](http://java.sun.com) Web site are frequently asked questions (**FAQs**) that provide brief answers to many common questions about Java software and products. You can also find several versions of the Java Development Kit (**JDK**) that you can download for free. Versions are available for Windows, Linux, and Solaris operating systems. You can search and browse documentation online or you can download the documentation file for the JDK and install it on your computer. After it is installed, you can search and browse documentation locally.



The JDK is an **SDK**—a software development kit that includes tools used by programmers.

A downloadable Java tutorial titled “The Java Tutorial: A practical guide for programmers” with hundreds of complete working examples is available from <http://java.sun.com/docs/books/tutorial/>. The tutorial is organized into trails—groups of lessons on a particular subject. You can start the tutorial at the beginning and navigate sequentially to the end, or you can jump from one trail to another. As you study each chapter in this book, you are encouraged to make good use of these support materials.

## TWO TRUTHS & A LIE

### Correcting Errors and Finding Help

1. When you compile a program, sometimes one error in syntax causes multiple error messages.
2. When you compile a program, sometimes multiple syntax errors cause only one error message.
3. Syntax errors are more difficult to find and resolve than logic errors.

The false statement is #3. Logic errors are usually more difficult to find and resolve than syntax errors. The compiler locates all syntax errors, but logic errors can be eliminated only through careful examination of your program and its output.

## You Do It

### Your First Application

Now that you understand the basics of an application written in Java, you are ready to enter your first Java application into a text editor. It is a tradition among programmers that the first program you write in any language produces “Hello, world!” as its output. You will create such a program now. You can use any text editor, such as Notepad, TextPad, or any other text-processing program.



It is best to use the simplest available text editor when writing Java programs. Multifeatured word-processing programs save documents as much larger files because of all the built-in features, such as font styles and margin settings, which you do not need in your Java programs.

### To write your first Java application:

1. Start any text editor (such as Notepad), and then open a new document, if necessary.
2. Type the class header as follows:

```
public class Hello
```

In this example, the class name is `Hello`. You can use any valid name you want for the class. If you choose *Hello*, you always must refer to the class as *Hello*, and not as *hello*, because Java is case sensitive.

3. Press **Enter** once, type `{`, press **Enter** again, and then type `}`. You will add the `main()` method between these curly braces. Although it is not required, it is good practice to place each curly brace on its own line and to align opening and closing curly brace pairs with each other. Using this format makes your code easier to read.
4. As shown in the shaded portion of Figure 1-18, add the `main()` method header between the curly braces, and then type a set of curly braces for `main()`.

```
public class Hello  
{  
    public static void main(String[] args)  
    {  
    }  
}
```

**Figure 1-18** The `main()` method shell for the `Hello` class

5. Next add the statement within the `main()` method that will produce the output, “Hello, world!”. Use Figure 1-19 as a guide for adding the shaded `println()` statement to the `main()` method.

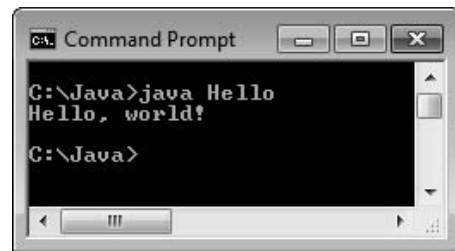
```
public class Hello
{
    public static void main(String[] args)
    {
        System.out.println("Hello, world!");
    }
}
```

**Figure 1-19** Complete Hello class

6. Save the application as **Hello.java**. Make certain that the file extension is .java. If it is not, the compiler for Java does not recognize the file as an application it can compile.
7. Go to the command-line prompt for the drive and folder or subdirectory in which you saved Hello.java. At the command line, type:

```
javac Hello.java
```

8. When the compile is successful, execute your application by typing **java Hello** at the command line. The output should appear on the next line, as shown in Figure 1-20.



**Figure 1-20** Output of Hello application

## Adding Comments to a Class

In this exercise, you add comments to your Hello.java application and save it as a new class named Hello2.

### To add comments to your application and save it as a new class:

1. Enter the following comments at the top of the Hello file, inserting your name and today's date where indicated.

```
// Filename Hello2.java
// Written by <your name>
// Written on <today's date>
```

2. Change the class name to **Hello2**, and then type the following block comment after the class header:

```
/* This class demonstrates the use of the println()
method to print the message Hello, world! */
```

3. Save the file as **Hello2.java**. The file must be named Hello2.java because the class name is Hello2.
4. Go to the command-line prompt for the drive and folder or subdirectory in which you saved Hello2.java, and type the following command to compile the program:

**javac Hello2.java**



If you receive an error message when you compile or run the program, look in the section “Saving, Compiling, Running, and Modifying a Java Application” to find its cause and then make the necessary corrections. Save the file again, and then repeat Step 4 until your application compiles successfully.

```

CA: Command Prompt
C:\Java>javac Hello2.java
C:\Java>java Hello2
Hello, world!
C:\Java>_
  
```

**Figure 1-21** Successful compilation and execution of Hello2 application

5. When the compile is successful, execute your application by typing **java Hello2** at the command line. The output should appear on the next line, as shown in Figure 1-21.



After the application compiles successfully, a file named Hello2.class is created and stored in the same folder as the Hello2.java file. If your application compiled without error but you receive an error message, such as “Exception in thread ‘main’ java.lang.NoClassDefFoundError,” when you try to execute the application, you probably do not have your class path set correctly. See Appendix A for details.



When you run a Java application using the `java` command, do not add the .class extension to the filename. If you type `java First`, the interpreter looks for a file named First.class. If you type `java First.class`, the interpreter incorrectly looks for a file named First.class.class.

## Modifying a Class

Next, you modify your Hello2 class, but to retain the Hello2 file, you save the modified file as the Hello3 class.

### To change the Hello2 class to the Hello3 class and rerun the application:

1. Open the file **Hello2.java** in your text editor. Change both the comment name and the class name to **Hello3**.
2. Add the following statement below the statement that displays “Hello, world!”:

```
System.out.println("I'm ready for Java programming!");
```

Be certain to type the semicolon at the end of the statement and use the correct case.

3. Save the file as **Hello3.java**. Then, at the command line, compile the file by typing the following command:

```
javac Hello3.java
```



If you receive compile errors, return to the Hello3.java file in the text editor, fix the errors, and then repeat Step 3 until the class compiles successfully.

4. Interpret and execute the class by typing the following command:

```
java Hello3
```

Your output should look like Figure 1-22.

```
C:\Java>java Hello3
Hello, world!
I'm ready for Java programming!
C:\Java>_
```

**Figure 1-22** Output of Hello3 application

## Creating a Dialog Box

Next, you write a Java application that produces output in a dialog box.

### To create an application that produces a dialog box as output:

1. Open a new file in your text editor. Type comments similar to the following, inserting your own name and today's date where indicated.

```
// Filename HelloDialog.java
// Written by <your name>
// Written on <today's date>
```

2. Enter the import statement that allows you to use the JOptionPane class:

```
import javax.swing.JOptionPane;
```

3. Enter the HelloDialog class:

```
public class HelloDialog
{
    public static void main(String[] args)
    {
        JOptionPane.showMessageDialog(null, "Hello,
            world!");
    }
}
```

4. Save the file as **HelloDialog.java**. Compile the class using the following command:

```
javac HelloDialog.java
```

If necessary, eliminate any syntax errors, resave the file, and recompile. Then execute the program using the following command:

```
java HelloDialog
```

The output appears as shown in Figure 1-23.



**Figure 1-23** Output of HelloDialog application

5. Click **OK** to dismiss the dialog box.

## Don't Do It

At the end of each chapter, a Don't Do It list will alert you to common mistakes made by beginning programmers.

- Don't forget that in Java, a public file's name must match the name of the class it contains. For example, if a file is named Program1.java, you can't simply rename it Program1BackUp.java and expect it to compile unless you change the class name within the file.
- Don't confuse the terms *parentheses*, *braces*, *brackets*, *curly braces*, *square brackets*, and *angle brackets*. When you are writing a program or performing some other computerized task and someone tells you, "Now, type some braces," you might want to clarify which term is meant. Table 1-5 summarizes these punctuation marks.

Punctuation	Name	Typical use in Java	Alternate names
( )	Parentheses	Follows method names as in <code>println()</code>	Parentheses can be called <i>round brackets</i> , but such usage is unusual
{ }	Curly braces	A pair surrounds a class body, a method body, and a block of code; when you learn about arrays in Chapter 8, you will find that curly braces also surround lists of array values	Curly braces might also be called <i>curly brackets</i>
[ ]	Square brackets	A pair signifies an array; arrays are covered in Chapter 8	Square brackets might be called <i>box brackets</i> or <i>square braces</i>
< >	Angle brackets	A pair of angle brackets surrounds HTML tags, as you will learn in Chapter 17; in Java, a pair also is used with generic arguments in parameterized classes	When angle brackets appear with nothing between them, they are called a <i>chevron</i>

**Table 1-5** Braces and brackets used in Java

- Don't forget to end a block comment. Every `/*` must have a corresponding `*/`, even if it is several lines later. It's harder to make a mistake with line comments (those that start with `//`), but remember that nothing on the line after the `//` will execute.
- Don't forget that Java is case sensitive.
- Don't forget to end every statement with a semicolon, but *not* to end class or method headers with a semicolon.
- Don't forget to recompile a program to which you have made changes. It can be very frustrating to fix an error, run a program, and not understand why you don't see evidence of your changes. The reason might be that the `.class` file does not contain your changes because you forgot to recompile.
- Don't panic when you see a lot of compiler error messages. Often, fixing one will fix several.
- Don't think your program is perfect when all compiler errors are eliminated. Only by running the program multiple times and carefully examining the output can you be assured that your program is logically correct.



## Key Terms

A computer **program** is a set of instructions that you write to tell a computer what to do.

The **logic** behind any program involves executing the various statements and procedures in the correct order to produce the desired results.

**Machine language** is a circuitry-level language that represents a series of on and off switches.

A **low-level programming language** is written to correspond closely to a computer processor's circuitry.

A **high-level programming language** allows you to use a vocabulary of reasonable terms, such as *read*, *write*, or *add*, instead of the sequences of on and off switches that perform these tasks.

**Syntax** refers to the rules of a language.

**Program statements** are similar to English sentences; they carry out the tasks that programs perform.

A **compiler**, or **interpreter**, is a program that translates language statements into machine code.

**Executing** a statement or program means to carry it out.

**Commands** are program statements.

**At run time** is a phrase that describes the period of time during which a program executes.

A **syntax error** is a programming error that occurs when you introduce typing errors into your program or use the programming language incorrectly. A program containing syntax errors will not compile.

The process of **debugging** a program frees it of all errors.

**Semantic errors** occur when you use a correct word in the wrong context in program code.

**Procedural programming** is a style of programming in which sets of operations are executed one after another in sequence.

An **application** is a program that performs a task for the user.

**Variables** are named computer memory locations that hold values that might vary.

**Procedures** are sets of operations performed by a computer program.

A procedural program **calls** a series of procedures to input, manipulate, and output values.

Writing **object-oriented programs** involves creating classes, creating objects from those classes, and creating applications that use those objects. Thinking in an object-oriented manner involves envisioning program components as objects that are similar to concrete objects in the real world; then, you can manipulate the objects to achieve a desired result.

**Computer simulations** are programs that attempt to mimic real-world activities so that their processes can be improved or so that users can better understand how the real-world processes operate.

**Graphical user interfaces**, or **GUIs** (pronounced “gooeys”) allow users to interact with a program in a graphical environment.

A **class** is a group or collection of objects with common properties.

A **class definition** describes what attributes its objects will have and what those objects will be able to do.

**Attributes** are the characteristics that define an object as part of a class.

**Properties** are attributes of a class.

An **object** is an instance of a class.

An **instance** of a class is an object.

To **instantiate** is to create an instance.

The **state** of an object is the set of values for its attributes.

A **method** is a self-contained block of program code, similar to a procedure.

**Encapsulation** refers to the hiding of data and methods within an object.

**Inheritance** is the ability to create classes that share the attributes and methods of existing classes, but with more specific features.

**Polymorphism** describes the feature of languages that allows the same word to be interpreted correctly in different situations based on the context.

**Java** was developed by Sun Microsystems as an object-oriented language used both for general-purpose business applications and for interactive, World Wide Web-based Internet applications.

**Architecturally neutral** describes the feature of Java that allows you to write programs that run on any platform (operating system).

The **Java Virtual Machine (JVM)** is a hypothetical (software-based) computer on which Java runs.

**Interactive applications** are those in which a user communicates with a program by using an input device.

**Source code** consists of programming statements written in a high-level programming language.

**Bytecode** consists of programming statements that have been compiled into binary format.

The **Java interpreter** is a program that checks bytecode and communicates with the operating system, executing the bytecode instructions line by line within the Java Virtual Machine.

**“Write once, run anywhere” (WORA)** is a slogan developed by Sun Microsystems to describe the ability of one Java program version to work correctly on multiple platforms.

**Applets** are Java programs that are embedded in a Web page.

**Java applications** are stand-alone Java programs.

**Console applications** support character output to a computer screen in a DOS window.

**Windowed applications** create a graphical user interface (GUI) with elements such as menus, toolbars, and dialog boxes.

A **literal string** is a series of characters that appear exactly as entered. Any literal string in Java appears between double quotation marks.

**Arguments** are information passed to a method so it can perform its task.

Sending arguments to a method is called **passing** them.

The **standard output device** is normally the monitor.

An **identifier** is a name of a program component such as a class, object, or variable.

**Unicode** is an international system of character representation.

Using an uppercase letter to begin an identifier and to start each new word in an identifier is known as **Pascal casing**.

An **access specifier** defines the circumstances under which a class can be accessed and the other classes that have the right to use a class.

The **class body** is the set of data items and methods between the curly braces that follow the class header.

**Whitespace** is any combination of nonprinting characters, such as spaces, tabs, and carriage returns (blank lines).

The **Allman style** is the indent style in which curly braces are aligned and each occupies its own line; it is named for Eric Allman, a programmer who popularized the style.

The **K & R style** is the indent style in which the opening brace follows the header line; it is named for Kernighan and Ritchie, who wrote the first book on the C programming language.

The keyword **static** means that a method is accessible and usable even though no objects of the class exist.

The keyword **void**, when used in a method header, indicates that the method does not return any value when it is called.

**Program comments** are nonexecuting statements that you add to a Java file for the purpose of documentation.

To **comment out** a statement is to turn it into a comment so the compiler will not execute its command.

**Line comments** start with two forward slashes ( // ) and continue to the end of the current line. Line comments can appear on a line by themselves or at the end of a line following executable code.

**Block comments** start with a forward slash and an asterisk ( /\* ) and end with an asterisk and a forward slash ( \*/ ). Block comments can appear on a line by themselves, on a line before executable code, or on a line after executable code. Block comments also can extend across as many lines as needed.

**Javadoc** comments are block comments that generate documentation. They begin with a forward slash and two asterisks ( /\*\* ) and end with an asterisk and a forward slash ( \*/ ).

A **clean build** is created when you delete all previously compiled versions of a class before compiling again.

**JOptionPane** is a Java class that allows you to produce dialog boxes.

A **dialog box** is a GUI object resembling a window in which you can place messages you want to display.

An **import statement** accesses a built-in Java class that is contained in a package.

A **package** contains a group of built-in Java classes.

A **compile-time error** is one in which the compiler detects a violation of language syntax rules and is unable to translate the source code to machine code.

**Parsing** is the process the compiler uses to divide source code into meaningful portions for analysis.

A **logic error** occurs when a program compiles successfully but produces an error during execution.

A **run-time error** occurs when a program compiles successfully but does not execute.

The **Java API** is the application programming interface, a collection of information about how to use every prewritten Java class.

**FAQs** are frequently asked questions.

The **JDK** is the Java Development Kit.

An **SDK** is a software development kit, or a set of tools useful to programmers.

## Chapter Summary

- A computer program is a set of instructions that tells a computer what to do. You can write a program using a high-level programming language, which has its own syntax, or rules of the language. After you write a program, you use a compiler or interpreter to translate the language statements into machine code.

- Writing object-oriented programs involves creating classes, creating objects from those classes, and creating applications—stand-alone executable programs that use those objects, which are similar to concrete objects in the real world. Object-oriented programming languages support encapsulation, inheritance, and polymorphism.
- A program written in Java is run on a standardized hypothetical computer called the Java Virtual Machine (JVM). When your class is compiled into bytecode, an interpreter within the JVM subsequently interprets the bytecode and communicates with your operating system to produce the program results.
- Everything that you use within a Java program must be part of a class; the contents of all classes are contained within opening and closing curly braces. Methods within classes hold statements. All Java programming statements end with a semicolon. Periods (called dots) are used to separate classes, objects, and methods in program code. All Java applications must have a method named `main()`. Most Java applications have additional methods.
- Program comments are nonexecuting statements that you add to a file for the purpose of documentation. Java provides you with three types of comments: line comments, block comments, and javadoc comments.
- To compile your source code from the command line, type `javac` followed by the name of the file that contains the source code. When you compile your source code, the compiler creates a file with a `.class` extension. You can run the `.class` file on any computer that has a Java language interpreter by entering the `java` command followed by the name of the class file. When you modify a class, you must recompile it for the changes to take effect.
- Java provides you with built-in classes that produce GUI output. For example, Java contains a class named `JOptionPane` that allows you to produce dialog boxes.
- To avoid and minimize syntax and logic errors, you must enter code carefully and closely examine your program's output.

## Review Questions

1. The most basic circuitry-level computer language, which consists of on and off switches, is \_\_\_\_\_.
  - a. a high-level language
  - b. machine language
  - c. Java
  - d. C++
2. Languages that let you use a vocabulary of descriptive terms, such as *read*, *write*, or *add*, are known as \_\_\_\_\_ languages.
  - a. high-level
  - b. machine
  - c. procedural
  - d. object-oriented

3. The rules of a programming language constitute its \_\_\_\_\_.
  - a. objects
  - b. logic
  - c. format
  - d. syntax
4. A \_\_\_\_\_ translates high-level language statements into machine code.
  - a. programmer
  - b. syntax detector
  - c. compiler
  - d. decipherer
5. Named computer memory locations are called \_\_\_\_\_.
  - a. compilers
  - b. variables
  - c. addresses
  - d. appellations
6. The individual operations used in a computer program are often grouped into logical units called \_\_\_\_\_.
  - a. procedures
  - b. variables
  - c. constants
  - d. logistics
7. Envisioning program components as objects that are similar to concrete objects in the real world is the hallmark of \_\_\_\_\_.
  - a. command-line operating systems
  - b. procedural programming
  - c. object-oriented programming
  - d. machine languages
8. The values of an object's attributes also are known as its \_\_\_\_\_.
  - a. state
  - b. orientation
  - c. methods
  - d. condition
9. An instance of a class is a(n) \_\_\_\_\_.
  - a. object
  - b. procedure
  - c. method
  - d. class
10. Java is architecturally \_\_\_\_\_.
  - a. specific
  - b. oriented
  - c. neutral
  - d. abstract
11. You must compile classes written in Java into \_\_\_\_\_.
  - a. bytecode
  - b. source code
  - c. javadoc statements
  - d. object code

12. All Java programming statements must end with a \_\_\_\_\_.
- a. period
  - b. comma
  - c. semicolon
  - d. closing parenthesis
13. Arguments to methods always appear within \_\_\_\_\_.
- a. parentheses
  - b. double quotation marks
  - c. single quotation marks
  - d. curly braces
14. In a Java program, you must use \_\_\_\_\_ to separate classes, objects, and methods.
- a. commas
  - b. semicolons
  - c. dots
  - d. forward slashes
15. All Java applications must have a method named \_\_\_\_\_.
- a. `method()`
  - b. `main()`
  - c. `java()`
  - d. `Hello()`
16. Nonexecuting program statements that provide documentation are called \_\_\_\_\_.
- a. classes
  - b. notes
  - c. comments
  - d. commands
17. Java supports three types of comments: \_\_\_\_\_, \_\_\_\_\_, and javadoc.
- a. line, block
  - b. string, literal
  - c. constant, variable
  - d. single, multiple
18. After you write and save a Java application file, you \_\_\_\_\_ it.
- a. interpret and then compile
  - b. interpret and then execute
  - c. compile and then resave
  - d. compile and then interpret
19. The command to execute a compiled Java application is \_\_\_\_\_.
- a. `run`
  - b. `execute`
  - c. `javac`
  - d. `java`
20. You save text files containing Java source code using the file extension \_\_\_\_\_.
- a. `.java`
  - b. `.class`
  - c. `.txt`
  - d. `.src`

## Exercises

- For each of the following Java identifiers, note whether it is legal or illegal:
  - weeklySales
  - last character
  - class
  - MathClass
  - myfirstinitial
  - phone#
  - abcdefghijklmnop
  - 23jordan
  - my\_code
  - 90210
  - year2013budget
  - abffraternity
- Name at least three attributes that might be appropriate for each of the following classes:
  - TelevisionSet
  - EmployeePaycheck
  - PatientMedicalRecord
- Name at least three objects that are members of each of the following classes:
  - Politician
  - SportingEvent
  - Book
- Name at least three classes to which each of these objects might belong:
  - mickeyMouse
  - myDogSpike
  - bostonMassachusetts
- Write, compile, and test a class that displays your first name on the screen. Save the class as **Name.java**.



As you work through the programming exercises in this book, you will create many files. To organize them, you might want to create a separate folder in which to store the files for each chapter.

- Write, compile, and test a class that displays your full name, street address, city, state, and zip code on three separate lines on the screen. Save the class as **Address.java**.
- Write, compile, and test a class that displays the following pattern on the screen:

```
X
XXX
XXXXX
XXXXXXX
X
```

Save the class as **Tree.java**.



8. Write, compile, and test a class that displays your initials on the screen. Compose each initial with five lines of initials, as in the following example:

```

      J   FFFFFF
      J   F
      J   FFFF
J     J   F
JJJJJ  F

```

Save the class as **Initial.java**.

9. Write, compile, and test a class that displays all the objectives listed at the beginning of this chapter. Save the class as **Objectives.java**.
10. Write, compile, and test a class that displays the following pattern on the screen:

```

 *
 * *
 * * *
 * *
 *

```

Save the class as **Diamond.java**.

11. Write, compile, and test a class that uses the command window to display the following statement about comments:
- “Program comments are nonexecuting statements you add to a file for the purpose of documentation.”
- Also include the same statement in three different comments in the class; each comment should use one of the three different methods of including comments in a Java class. Save the class as **Comments.java**.
12. Modify the Comments.java program in Exercise 11 so that the statement about comments is displayed in a dialog box. Save the class as **CommentsDialog.java**.
13. From 1925 through 1963, Burma Shave advertising signs appeared next to highways all across the United States. There were always four or five signs in a row containing pieces of a rhyme, followed by a final sign that read “Burma Shave.” For example, one set of signs that has been preserved by the Smithsonian Institution reads as follows:

```

Shaving brushes
You'll soon see 'em
On a shelf
In some museum
Burma Shave

```

Find a classic Burma Shave rhyme on the Web. Write, compile, and test a class that produces a series of four dialog boxes so that each displays one line of a Burma Shave slogan in turn. Save the class as **BurmaShave.java**.

14. Write a Java application to display an attractive layout of the information in a typical business card. Data items in a typical business card include a name, address, city, state, zip code, home phone number, and work phone number. Save the class as **CardLayout.java**.



## Debugging Exercise

15. Each of the following files in the Chapter.01 folder in your downloadable student files has syntax and/or logic errors. In each case, determine the problem and fix the errors. After you correct the errors, save each file using the same filename preceded with Fix. For example, DebugOne1.java will become FixDebugOne1.java.
  - a. DebugOne1.java
  - b. DebugOne2.java
  - c. DebugOne3.java
  - d. DebugOne4.java



When you change a filename, remember to change every instance of the class name within the file so that it matches the new filename. In Java, the filename and class name must always match.



## Game Zone

16. In 1952, A. S. Douglas wrote his University of Cambridge Ph.D. dissertation on human-computer interaction, and created the first graphical computer game—a version of Tic-Tac-Toe. The game was programmed on an EDSAC vacuum-tube mainframe computer. The first computer game is generally assumed to be “Spacewar!”, developed in 1962 at MIT; the first commercially available video game was “Pong,” introduced by Atari in 1973. In 1980, Atari’s “Asteroids” and “Lunar Lander” became the first video games to be registered in the U. S. Copyright Office. Throughout the 1980s, players spent hours with games that now seem very simple and unglamorous; do you recall playing “Adventure,” “Oregon Trail,” “Where in the World is Carmen Sandiego?,” or “Myst”?

Today, commercial computer games are much more complex; they require many programmers, graphic artists, and testers to develop them, and large management and marketing staffs are needed to promote them. A game might cost many millions of dollars to develop and market, but a successful game might earn hundreds of millions of dollars. Obviously, with the brief introduction to programming you have had in this chapter, you cannot create a very sophisticated game. However, you can get started.

For games to hold your interest, they almost always include some random, unpredictable behavior. For example, a game in which you shoot asteroids loses some of its fun if the asteroids follow the same, predictable path each time you play the game. Therefore, generating random values is a key component in creating most interesting computer games.

Appendix D contains information on generating random numbers. To fully understand the process, you must learn more about Java classes and methods. However, for now, you can copy the following statement to generate and use a dialog box that displays a random number between 1 and 10:

```
JOptionPane.showMessageDialog(null,"The number is " +  
    (1 + (int)(Math.random() * 10)));
```

Write a Java application that displays two dialog boxes in sequence. The first asks you to think of a number between 1 and 10. The second displays a randomly generated number; the user can see whether his or her guess was accurate. (In future chapters you will improve this game so that the user can enter a guess and the program can determine whether the user was correct. If you wish, you also can tell the user how far off the guess was, whether the guess was high or low, and provide a specific number of repeat attempts.) Save the file as **RandomGuess.java**.

*This page intentionally left blank*

# Using Data

In this chapter, you will:

- ① Use constants and variables
- ① Use integer data types
- ① Use the `boolean` data type
- ① Use floating-point data types
- ① Use the `char` data type
- ① Display data and perform arithmetic
- ① Understand numeric type conversion
- ① Use the `Scanner` class to accept keyboard input
- ① Use the `JOptionPane` class for GUI input

## Using Constants and Variables

You can categorize data items as constant or variable. A data item is **constant** when its value cannot be changed while a program is running; a data item is variable when its value might change. For example, when you include the following statement in a Java class, the number 459 is a constant:

```
System.out.println(459);
```

Every time an application containing the constant 459 is executed, the value 459 is displayed. Programmers refer to the number 459 as a **literal constant** because its value is taken literally at each use. The number 459 is also a **numeric constant** as opposed to a character or string constant. Additionally, it is an **unnamed constant** as opposed to a named one, because no identifier is associated with it.



A literal numeric constant contains digits and an optional sign that indicates whether the constant is positive or negative. Floating-point constants also contain a decimal point. In the new Java 7, an `int` or `long` can contain underscores to improve readability. For example, you can write the value *one million* as either 1000000 or 1\_000\_000.

On the other hand, you can set up a data item as a variable. A **variable** is a named memory location that you can use to store a value. A variable can hold only one value at a time, but the value it holds can change. For example, if you create a variable named `ovenTemperature`, it might hold 0 when the application starts, later be altered to hold 350, and still later be altered to hold 400.

Whether a data item is variable or constant, in Java it always has a data type. An item's **data type** describes the type of data that can be stored there, how much memory the item occupies, and what types of operations can be performed on the data. Java provides for eight primitive types of data. A **primitive type** is a simple data type. The eight types are described in Table 2-1.

Keyword	Description
<code>byte</code>	Byte-length integer
<code>short</code>	Short integer
<code>int</code>	Integer
<code>long</code>	Long integer
<code>float</code>	Single-precision floating point
<code>double</code>	Double-precision floating point
<code>char</code>	A single character
<code>boolean</code>	A Boolean value ( <code>true</code> or <code>false</code> )

**Table 2-1** Java primitive data types

The eight primitive data types are called “primitive” because they are simple and uncomplicated. Primitive types also serve as the building blocks for more complex data types, called **reference types**. The value of a reference type is a memory address. The classes you will begin creating in Chapter 3 are examples of reference types, as is the `Scanner` class you will use later in this chapter.

## Declaring Variables

A **variable declaration** is a statement that reserves a named memory location and includes the following:

- A data type that identifies the type of data that the variable will store
- An identifier that is the variable's name
- An optional assignment operator and assigned value, if you want a variable to contain an initial value
- An ending semicolon

You name variables using the same naming rules as you do for legal class identifiers. Basically, variable names must start with a letter and cannot be a reserved keyword. You must declare all variables you want to use in a class, and you must declare them before you can use them. Java is a **strongly typed language**, or one in which all variables must be declared before they can be used.

Variable names conventionally begin with lowercase letters to distinguish them from class names. However, as with class names, a program can compile without error even if names are constructed unconventionally.



Beginning an identifier with a lowercase letter and capitalizing subsequent words within the identifier is a style known as **camel casing**. An identifier such as `lastName` resembles a camel because of the uppercase "hump" in the middle.

For example, the following declaration creates a variable of type `int` named `myAge` and assigns it an initial value of 25:

```
int myAge = 25;
```

This declaration is a complete statement that ends in a semicolon. The equal sign (`=`) is the **assignment operator**. Any value to the right of the equal sign is assigned to the variable on the left of the equal sign. An assignment made when you declare a variable is an **initialization**; an assignment made later is simply an **assignment**. Thus, the first statement that follows is an initialization, and the second is an assignment:

```
int myAge = 25;  
myAge = 42;
```

You declare a variable just once, but you might assign new values to it any number of times.



The assignment operator means "is assigned the value of the following expression." In other words, the statement `myAge = 25` can be read as "myAge is assigned the value of the following expression: 25."

Note that an expression with a literal to the left of the assignment operator (such as `25 = myAge`) is illegal. The assignment operator has right-to-left associativity. **Associativity** refers to the order

in which values are used with operators. The associativity of every operator is either right-to-left or left-to-right.



An identifier that can appear on the left side of an assignment statement sometimes is referred to as an **lvalue**. A numeric constant like 25 is not an lvalue; it is only an **rvalue**, or an item that can appear only on the right side of an assignment statement. A variable can be used as an lvalue or an rvalue, but a literal number can only be an rvalue.

The following variable declaration also declares a variable of type `int` named `myAge`, but no value is assigned at the time of creation:

```
int myAge;
```

If you attempt to display a variable that has not been assigned a value, or use it as part of a calculation, you receive an error message stating that the variable might not have been initialized. Java protects you from inadvertently using the unknown value (known as a **garbage value**) that is stored in an uninitialized variable.



When you learn about creating classes in the chapter *Using Methods, Classes, and Objects*, you will discover that variables declared in a class, but outside any method, are automatically initialized for you.

You can declare multiple variables of the same type in separate statements. You also can declare two (or more) variables of the same type in a single statement by separating the variable declarations with a comma, as shown in the following statement:

```
int myAge = 25, yourAge = 19;
```

By convention, programmers declare most variables in separate statements. You might declare multiple variables in the same statement only if they are closely related. Remember that even if a statement occupies multiple lines, the statement is not complete until the semicolon is reached.

You can declare as many variables in a statement as you want, as long as the variables are the same data type. However, if you want to declare variables of different types, you must use a separate statement for each type.

## Declaring Named Constants

A variable is a named memory location for which the contents can change. If a named location's value should not change during the execution of a program, you can create it to be a **named constant**. A named constant is also known as a **symbolic constant**. A named constant is similar to a variable in that it has a data type, a name, and a value. A named constant differs from a variable in several ways:



- In its declaration statement, the data type of a named constant is preceded by the keyword **final**.
- A named constant can be assigned a value only once, and then it can never be changed. Usually you initialize a named constant when you declare it; if you do not initialize the constant at declaration, it is known as a **blank final**, and you can assign a value later. You can assign a value to a **final** variable only once, and you must assign a value before the variable is used.
- Although it is not a requirement, named constants conventionally are given identifiers using all uppercase letters, using underscores as needed to separate words.

For example, each of the following defines a named constant:

```
final int NUMBER_OF_DEPTS = 20;
final double PI = 3.14159;
final double TAX_RATE = 0.015;
final string COMPANY = "ABC Manufacturing";
```

You can use each of these named constants anywhere you can use a variable of the same type, except on the left side of an assignment statement. In other words, after they receive their initial values, named constants are rvalues.

A constant always has the same value within a program, so you might wonder why you cannot use the actual, literal value. For example, why not code 20 when you need the number of departments instead of going to the trouble of creating the `NUMBER_OF_DEPTS` named constant? There are several good reasons to use the named constant rather than the literal one:

- The number 20 is more easily recognized as the number of departments if it is associated with an identifier. Using named constants makes your programs easier to read and understand.



Some programmers refer to the use of a literal numeric constant, such as 20, as using a **magic number**—a value that does not have immediate, intuitive meaning or a number that cannot be explained without additional knowledge. These programmers prefer that you use a named variable or constant in place of every numeric value. For example, you might write a program that uses the value 7 several times, or you might use constants such as `DAYS_IN_WEEK` and `NUM_RETAIL_OUTLETS` that both hold the value 7 but more clearly describe its purpose. Avoiding magic numbers helps provide internal documentation for your programs.

- If the number of departments in your organization changes, you would change the value of `NUMBER_OF_DEPTS` at one location within your program—where the constant is defined—rather than searching for every use of 20 to change it to a different number. Being able to make the change at one location saves you time, and prevents you from missing a reference to the number of departments.
- Even if you are willing to search for every instance of 20 in a program to change it to the new department number value, you might inadvertently change the value of one instance of 20 that is being used for something else, such as a payroll deduction value.

- Using named constants reduces typographical errors. For example, if you must include 20 at several places within a program, you might inadvertently type 10 for one of the instances.
- When you use a named constant in an expression, it stands out as separate from a variable. For example, in the following arithmetic statement, it is easy to see which elements are variable and which are constant because the constants have been named conventionally:

```
double payAmount = hoursWorked * STD_PAY_RATE -  
    numDependents * DEDUCTION;
```



Although many programmers use named constants to stand for most of the constant values in their programs, many make an exception when using 0 or 1.

## The Scope of Variables and Constants

A data item's **scope** is the area in which it is visible to a program and in which you can refer to it using its simple identifier. A variable or constant is in scope from the point it is declared until the end of the block of code in which the declaration lies. Frequently, this means a variable or constant can be used from its declaration until the end of the method in which it is declared. However, if a method contains multiple sets of curly braces, then a data item is usable only until the end of the block that holds the declaration.



In the chapter *Using Methods, Classes, and Objects* you will start to create classes that contain multiple sets of curly braces. In the chapter *More Object Concepts* you will learn some techniques for using variables that are not currently in scope.

## Pitfall: Forgetting That a Variable Holds One Value at a Time

Each constant can hold only one value for the duration of its program; each variable can hold just one value at a time. Suppose you have two variables, *x* and *y*, and *x* holds 2 and *y* holds 10. Suppose further that you want to switch their values so that *x* holds 10 and *y* holds 2. You cannot simply make an assignment such as *x* = *y* because then both variables will hold 10, and the 2 will be lost. Similarly, if you make the assignment *y* = *x*, then both variables will hold 2, and the 10 will be lost. The solution is to declare and use a third variable, as in the following sequence of events:

```
int x = 2, y = 10, z;  
z = x;  
x = y;  
y = z;
```

In this example, the third variable, *z*, is used as a temporary holding spot for one of the original values. The variable *z* is assigned the value of *x*, so *z* becomes 2. Then the value of *y*, 10, is assigned to *x*. Finally, the 2 held in *z* is assigned to *y*. The extra variable is used because as soon as you assign a value to a variable, any value that was previously in the memory location is gone.



Watch the video *Declaring Variables and Constants*.

## TWO TRUTHS & A LIE

### Using Constants and Variables

1. A variable is a named memory location that you can use to store a value; it can hold only one value at a time, but the value it holds can change.
2. An item's data type determines what legal identifiers can be used to describe variables and whether the variables can occupy memory.
3. A variable declaration is a statement that reserves a named memory location and includes a data type, an identifier, an optional assignment operator and assigned value, and an ending semicolon.

The false statement is #2. An item's data type describes the type of data that can be stored, how much memory the item occupies, and what types of operations can be performed on the data. The data type does not alter the rules for a legal identifier, and the data type does not determine whether variables can occupy memory—all variables occupy memory.

## Learning About Integer Data Types

In Java, you can use variables of types `byte`, `short`, `int`, and `long` to store (or hold) integers; an **integer** is a whole number without decimal places.

The `int` data type is the most commonly used integer type. A variable of type `int` can hold any whole number value from  $-2,147,483,648$  to  $+2,147,483,647$ . When you assign a value to an `int` variable, you do not type any commas or periods; you type only digits and an optional plus or minus sign to indicate a positive or negative integer.



The legal integer values are  $-2^{31}$  through  $2^{31}-1$ . These are the highest and lowest values that you can store in four bytes of memory, which is the size of an `int` variable.

The types **byte**, **short**, and **long** are all variations of the integer type. The `byte` and `short` types occupy less memory and can hold only smaller values; the `long` type occupies more memory and can hold larger values. Table 2-2 shows the upper and lower value limits for each of these types.

Type	Minimum Value	Maximum Value	Size in Bytes
byte	-128	127	1
short	-32,768	32,767	2
int	-2,147,483,648	2,147,483,647	4
long	-9,223,372,036,854,775,808	9,223,372,036,854,775,807	8

**Table 2-2** Limits on integer values by type



In other programming languages, the format and size of primitive data types might depend on the platform on which a program is running. In contrast, Java consistently specifies the size and format of its primitive data types.

It is important to choose appropriate types for the variables you will use in an application. If you attempt to assign a value that is too large for the data type of the variable, the compiler issues an error message and the application does not execute. If you choose a data type that is larger than you need, you waste memory. For example, a personnel application might use a **byte** variable for number of dependents (because a limit of 127 is more than enough), a **short** for hours worked in a month (because 127 isn't enough), and an **int** for an annual salary (because even though a limit of 32,000 might be large enough for your salary, it isn't enough for the CEO's).



Some famous glitches have occurred because programmers did not pay attention to the limits of various data types. For example, a hospital computer system in Washington, D.C. used the equivalent of a **short** to count days elapsed since January 1, 1900. The system collapsed on the 32,768th day (which was in 1989), requiring manual operations for a lengthy period.

If an application uses a literal constant integer, such as 932, the number is an **int** by default. If you need to use a constant higher than 2,147,483,647, you must follow the number with the letter *L* to indicate **long**. For example, the following statement stores a number that is greater than the maximum limit for the **int** type.

```
long mosquitosInTheNorthWoods = 2444555888L;
```

You can type either an uppercase or lowercase *L* after the digits to indicate the **long** type, but the uppercase *L* is preferred to avoid confusion with the number 1. You need no special notation to store a numeric constant in a **byte** or a **short**.



Because integer constants, such as 18, are type **int** by default, the examples in this book almost always declare a variable as type **int** when the variable's purpose is to hold a whole number. That is, even if the expected value is less than 127, such as `hoursWorkedToday`, this book will declare the variable to be an **int**. If you are writing an application in which saving memory is important, you might choose to declare the same variable as a **byte**.

## TWO TRUTHS & A LIE

### Learning About Integer Data Types

1. A variable of type `int` can hold any whole number value from approximately negative two billion to positive two billion.
2. When you assign a value to an `int` variable, you do not type any commas; you type only digits and an optional plus or minus sign to indicate a positive or negative integer.
3. You can use the data types `byte` or `short` to hold larger values than can be accommodated by an `int`.

59

The false statement is #3. You use a `long` if you know you will be working with very large values; you use a `byte` or a `short` if you know a variable will need to hold only small values.

## Using the boolean Data Type

Boolean logic is based on true-or-false comparisons. Whereas an `int` variable can hold millions of different values (at different times), a **boolean variable** can hold only one of two values—`true` or `false`. The following statements declare and assign appropriate values to Boolean variables:

```
boolean isItPayday = false;
boolean areYouBroke = true;
```

You also can assign values based on the result of comparisons to Boolean variables. Java supports six relational operators that are used to make comparisons. A **relational operator** compares two items; it is sometimes called a **comparison operator**. An expression that contains a relational operator has a Boolean value. Table 2-3 describes the relational operators.



When you use *Boolean* as an adjective, as in *Boolean operators*, you usually begin with an uppercase *B* because the data type is named for Sir George Boole, the founder of symbolic logic, who lived from 1815 to 1864. The Java data type *boolean*, however, begins with a lowercase *b*.

Operator	Description	True Example	False Example
<	Less than	3 < 8	8 < 3
>	Greater than	4 > 2	2 > 4
==	Equal to	7 == 7	3 == 9
<=	Less than or equal to	5 <= 5	8 <= 6
>=	Greater than or equal to	7 >= 3	1 >= 2
!=	Not equal to	5 != 6	3 != 3

**Table 2-3** Relational operators

When you use any of the operators that have two symbols ( ==, <=, >=, or != ), you cannot place any whitespace between the two symbols. You also cannot reverse the order of the symbols. That is, =<, =>, and != are all invalid operators.

Legal declaration statements might include the following statements, which compare two values directly:

```
boolean isSixBigger = (6 > 5);
// Value stored would be true
boolean isSevenSmallerOrEqual = (7 <= 4);
// Value stored would be false
```



Although you can use any legal identifier for Boolean variables, they are easily identified as Boolean if you use a form of *to be* (such as *is* or *are*) as part of the variable name, as in `isSixBigger`.

The Boolean expressions are more meaningful when variables (that have been assigned values) are used in the comparisons, as in the following examples. In the first statement, the `hours` variable is compared to a constant value of 40. If the `hours` variable is not greater than 40, the expression evaluates to `false`. In the second statement, the `income` variable must be greater than 100000 for the expression to evaluate to `true`. In the third statement, two variables are compared to determine the value of `isFirstScoreHigher`.

```
boolean isOvertimePay = (hours > 40);
boolean isTaxBracketHigh = (income > 100000);
boolean isFirstScoreHigher = (score1 > score2);
```

## TWO TRUTHS & A LIE

### Using the boolean Data Type

1. A Boolean variable can hold only one of two values—`true` or `false`.
2. Java supports six relational operators that are used to make comparisons: `=`, `<`, `>`, `=<`, `=>`, and `!=`.
3. An expression that contains a relational operator has a Boolean value.

The false statement is #2. The six relational operators used to make comparisons are `==` (two equal signs), `<`, `>`, `<=`, `>=`, and `!=` (the less-than sign precedes the equal sign), `<=` (the greater-than sign precedes the equal sign), and `!=` (the exclamation point precedes the equal sign).

## Learning About Floating-Point Data Types

A **floating-point** number contains decimal positions. Java supports two floating-point data types: `float` and `double`. A **float** data type can hold floating-point values of up to six or seven significant digits of accuracy. A **double** data type requires more memory than a `float`, and can hold 14 or 15 significant digits of accuracy. The term **significant digits** refers to the mathematical accuracy of a value. For example, a `float` given the value 0.324616777 displays as 0.324617 because the value is accurate only to the sixth decimal position. Table 2-4 shows the minimum and maximum values for each floating-point data type.



A `float` given the value 324616777 displays as 3.24617e+008, which means approximately 3.24617 times 10 to the 8th power, or 324617000. The `e` in the displayed value stands for exponent; the `+008` means the true decimal point is eight positions to the right of where it is displayed, indicating a very large number. (A negative number would indicate that the true decimal point belongs to the left, indicating a very small number.) This format is called **scientific notation**. The large value contains only six significant digits.



A programmer might choose to store a value as a `float` instead of a `double` to save memory. However, if high levels of accuracy are needed, such as in graphics-intensive software, the programmer might choose to use a `double`, opting for high accuracy over saved memory.

Type	Minimum	Maximum	Size in Bytes
<code>float</code>	$-3.4 * 10^{38}$	$3.4 * 10^{38}$	4
<code>double</code>	$-1.7 * 10^{308}$	$1.7 * 10^{308}$	8

**Table 2-4** Limits on floating-point values



A value written as  $3.4 * 10^{38}$  indicates that the value is 3.4 multiplied by 10 to the 38th power, or 10 with 38 trailing zeros—a very large number.



A value stored in a `double` is a **double-precision floating-point number**; a value in a `float` is a **single-precision floating-point number**.

Just as an integer constant, such as 178, is a value of type `int` by default, a floating-point constant, such as 18.23, is a `double` by default. To store a value explicitly as a `float`, you can type the letter *F* after the number, as in the following:

```
float pocketChange = 4.87F;
```

You can type either a lowercase or an uppercase *F*. You also can type *D* (or *d*) after a floating-point constant to indicate it is a `double`, but even without the *D*, the value will be stored as a `double` by default. Floating-point numbers can be imprecise, as you will see later in this chapter.

## TWO TRUTHS & A LIE

### Learning About Floating-Point Data Types

1. Java supports two floating-point data types: `float` and `double`. The `double` data type requires more memory and can hold more significant digits.
2. A floating-point constant, such as 5.6, is a `float` by default.
3. As with integers, you can perform the mathematical operations of addition, subtraction, multiplication, and division with floating-point numbers.

The false statement is #2. A floating-point constant, such as 5.6, is a `double` by default.

## Working with the char Data Type

You use the `char` data type to hold any single character. You place constant character values within single quotation marks because the computer stores characters and integers differently. For example, the following are typical character declarations:

```
char middleInitial = 'M';  
char gradeInChemistry = 'A';  
char aStar = '*';
```





Some programmers prefer to pronounce *char* as *care* because it represents the first syllable in the word *character*. Others prefer to pronounce the word as *char* to rhyme with *car*. You should use the preferred pronunciation in your organization.

A character can be any letter—uppercase or lowercase. It might also be a punctuation mark or digit. A character that is a digit is represented in computer memory differently than a numeric value represented by the same digit. For example, the following two statements are legal:

```
char aCharValue = '9';
int  aNumValue = 9;
```

If you display each of these values using a `println()` statement, you see a 9. However, only the numeric value, `aNumValue`, can be used to represent the value 9 in arithmetic statements.

A numeric constant can be stored in a character variable and a character that represents a number can be stored in a numeric variable. For example, the following two statements are legal, but unless you understand their meanings, they might produce undesirable results:

```
char aCharValue = 9;
int  aNumValue = '9';
```

If these variables are used in the following `println()` statement, then the resulting output produces a blank for `aCharValue` and the number 57 for `aNumValue`:

```
System.out.println("aCharValue is " + aCharValue +
    "aNumValue is " + aNumValue);
```

The unexpected values are Unicode values. Every computer stores every character it uses as a number; every character is assigned a unique numeric code using Unicode. Table 2-5 shows some Unicode decimal values and their character equivalents. For example, the character 'A' is stored using the value 65 and the character 'B' is stored using the value 66. Appendix B contains more information on Unicode.

Dec	Char	Dec	Char	Dec	Char	Dec	Char
0	nul	32		64	@	96	`
1	soh^A	33	!	65	A	97	a
2	stx^B	34	"	66	B	98	b
3	etx^C	35	#	67	C	99	c
4	eot^D	36	\$	68	D	100	d
5	enq^E	37	%	69	E	101	e
6	ask^F	38	&	70	F	102	f
7	bel^G	39	'	71	G	103	g
8	bs^H	40	(	72	H	104	h

**Table 2-5** Unicode values 0 through 127 and their character equivalents (*continues*)

(continued)

Dec	Char	Dec	Char	Dec	Char	Dec	Char
9	ht^I	41	)	73		105	i
10	lf^J	42	*	74	J	106	j
11	vt^K	43	+	75	K	107	k
12	ff^L	44	,	76	L	108	l
13	cr^M	45	-	77	M	109	m
14	so^N	46	.	78	N	110	n
15	si^O	47	/	79	O	111	o
16	dle^P	48	0	80	P	112	p
17	dc1^Q	49	1	81	Q	113	q
18	dc2^R	50	2	82	R	114	r
19	dc3^S	51	3	83	S	115	s
20	dc4^T	52	4	84	T	116	t
21	nak^U	53	5	85	U	117	u
22	syn^V	54	6	86	V	118	v
23	etb^W	55	7	87	W	119	w
24	can^X	56	8	88	X	120	x
25	em^Y	57	9	89	Y	121	y
26	sub^Z	58	:	90	Z	122	z
27	esc	59	;	91	[	123	{
28	fs	60	<	92	\	124	
29	gs	61	=	93	]	125	}
30	rs	62	>	94	^	126	~
31	us	63	?	95	_	127	del

**Table 2-5** Unicode values 0 through 127 and their character equivalents

A variable of type `char` can hold only one character. To store a string of characters, such as a person's name, you must use a data structure called a `String`. In Java, `String` is a built-in class that provides you with the means for storing and manipulating character strings. Unlike single characters, which use single quotation marks, string constants are written between double quotation marks. For example, the expression that stores the name *Audrey* as a string in a variable named `firstName` is:

```
String firstName = "Audrey";
```



You will learn more about strings and the `String` class in the chapter *Characters, Strings, and the `StringBuilder`*.

You can store any character—including nonprinting characters such as a backspace or a tab—in a `char` variable. To store these characters, you can use an **escape sequence**, which always begins with a backslash followed by a character—the pair represents a single character. For example, the following code stores a newline character and a tab character in the `char` variables `aNewLine` and `aTabChar`:

```
char aNewLine = '\n';
char aTabChar = '\t';
```

In the declarations of `aNewLine` and `aTabChar`, the backslash and character pair acts as a single character; the escape sequence serves to give a new meaning to the character. That is, the literal characters in the preceding code have different values from the “plain” characters ‘n’ or ‘t’. Table 2-6 describes some common escape sequences that you can use with command window output in Java.

Escape Sequence	Description
<code>\b</code>	Backspace; moves the cursor one space to the left
<code>\t</code>	Tab; moves the cursor to the next tab stop
<code>\n</code>	Newline or linefeed; moves the cursor to the beginning of the next line
<code>\r</code>	Carriage return; moves the cursor to the beginning of the current line
<code>\"</code>	Double quotation mark; displays a double quotation mark
<code>\'</code>	Single quotation mark; displays a single quotation mark
<code>\\</code>	Backslash; displays a backslash character

**Table 2-6** Common escape sequences



When you display values within `JOptionPane` dialog boxes rather than in a command window, the escape sequences ‘n’ (newline), ‘\’ (double quote), and ‘\’ (backslash) operate as expected within a `JOptionPane` object, but ‘t’, ‘b’, and ‘r’ do not work in the GUI environment.

When you want to produce console output on multiple lines in the command window, you have two options: You can use the newline escape sequence, or you can use the `println()` method multiple times. For example, Figures 2-1 and 2-2 both show classes that produce the same output: “Hello” on one line and “there” on another. The version you choose to use is up to you. The example in Figure 2-1 is more efficient—from a typist’s point of view because the text `System.out.println` appears only once, and from the compiler’s point of view because the `println()` method is called only once. The example in Figure 2-2, however, might be easier to read and understand. When programming in Java, you will find occasions when each of these approaches makes sense.

```
public class HelloThereNewLine
{
    public static void main(String[] args)
    {
        System.out.println("Hello\nthere");
    }
}
```

Figure 2-1 HelloThereNewLine class

```
public class HelloTherePrintInTwice
{
    public static void main(String[] args)
    {
        System.out.println("Hello");
        System.out.println("there");
    }
}
```

Figure 2-2 HelloTherePrintInTwice class



The `println()` method uses the local platform's line terminator character, which might or might not be the newline character `'\n'`.

## TWO TRUTHS & A LIE

### Working with the char Data Type

1. You use the `char` data type to hold any single character; you place constant character values within single quotation marks.
2. To store a string of characters, you use a data structure called a `Text`; string constants are written between parentheses.
3. An escape sequence always begins with a backslash followed by a character; the pair represents a single character.

The false statement is #2. To store a string of characters, you use a data structure called a `String`; string constants are written between double quotation marks.

## Displaying Data and Performing Arithmetic

You can display a variable or a constant in a `print()` or `println()` statement alone or in combination with a string. For example, the `NumbersPrintln` class shown in Figure 2-3 declares an integer `billingDate`, which is initialized to 5. In the first shaded statement, the value of `billingDate` is sent alone to the `print()` method; in the second shaded statement, `billingDate` is combined with, or **concatenated** to, a `String`. In Java, when a numeric variable is concatenated to a `String` using the plus sign, the entire expression becomes a `String`. The `println()` method can accept either a number or a `String`, so both statements work. The output of the application shown in Figure 2-3 appears in Figure 2-4.



When a method like `println()` can accept different argument types, the method is *overloaded*. When a method is overloaded, it means there are multiple versions with the same name that can be used with a variety of options. You will learn about overloaded methods in the chapter *More Object Concepts*.

```
public class NumbersPrintln
{
    public static void main(String[] args)
    {
        int billingDate = 5;
        System.out.print("Bills are sent on day ");
        System.out.print(billingDate);
        System.out.println(" of the month");
        System.out.println("Next bill: October " +
            billingDate);
    }
}
```

Figure 2-3 `NumbersPrintln` class

```
Command Prompt
C:\Java>java NumbersPrintln
Bills are sent on day 5 of the month
Next bill: October 5
C:\Java>_
```

Figure 2-4 Output of `NumbersPrintln` application



Later in this chapter, you will learn that a plus sign (+) between two numeric values indicates an addition operation. However, when you place a string on one or both sides of a plus sign, concatenation occurs. In Chapter 1, you learned that *polymorphism* describes the feature of languages that allows the same word or symbol to be interpreted correctly in different situations based on the context. The plus sign is polymorphic in that it indicates concatenation when used with strings but addition when used with numbers.

The program in Figure 2-3 uses the command line to display values, but you also can use a dialog box. Recall from Chapter 1 that you can use the `showMessageDialog()` method with two arguments: `null`, which indicates the box should appear in the center of the screen, and the `String` to be displayed in the box. Figure 2-5 shows a `NumbersDialog` class that uses the `showMessageDialog()` method twice to display an integer declared as `creditDays` and initialized to 30. In each shaded statement in the class, the numeric variable is concatenated to a `String`, making the entire second argument a `String`. In the first shaded statement, the concatenated `String` is an empty `String` (or **null String**), created by typing a set of quotes with nothing between them. The application produces the two dialog boxes shown in Figures 2-6 and 2-7. The first dialog box shows just the value 30; after it is dismissed by clicking OK, the second dialog box appears.

```
import javax.swing.JOptionPane;
public class NumbersDialog
{
    public static void main(String[] args)
    {
        int creditDays = 30;
        JOptionPane.showMessageDialog(null, "" + creditDays);
        JOptionPane.showMessageDialog
            (null, "Every bill is due in " + creditDays + " days");
    }
}
```

Figure 2-5 NumbersDialog class

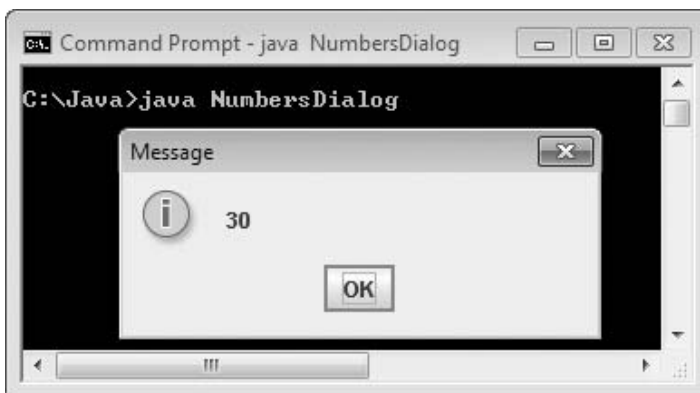
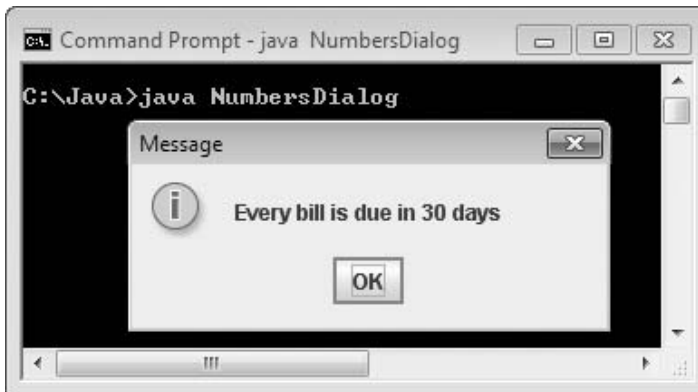


Figure 2-6 First dialog box created by NumbersDialog application



**Figure 2-7** Second dialog box created by NumbersDialog application

## Performing Arithmetic

Table 2-7 describes the five standard arithmetic operators. You use **arithmetic operators** to perform calculations with values in your programs. A value used on either side of an operator is an **operand**. For example, in the expression  $45 + 2$ , the numbers 45 and 2 are operands. The arithmetic operators are examples of **binary operators**, so named because they require two operands.



You will learn about the Java shortcut arithmetic operators in the chapter *Looping*.

Operator	Description	Example
+	Addition	$45 + 2$ , the result is 47
-	Subtraction	$45 - 2$ , the result is 43
*	Multiplication	$45 * 2$ , the result is 90
/	Division	$45.0 / 2$ , the result is 22.5 $45 / 2$ , the result is 22 (not 22.5)
%	Remainder (modulus)	$45 \% 2$ , the result is 1 (that is, $45 / 2 = 22$ with a remainder of 1)

**Table 2-7** Arithmetic operators



When you perform paper-and-pencil division, you divide first to determine a remainder. In Java, you do not need to perform a division operation before you can perform a remainder operation. A remainder operation can stand alone.

The operators `/` and `%` deserve special consideration. Java supports two types of division:

- **Floating-point division** occurs when either or both of the operands are floating-point values. For example,  $45.0 / 2$  is 22.5.
- **Integer division** occurs when both of the operands are integers. The result is an integer, and any fractional part of the result is lost. For example, the result of  $45 / 2$  is 22. As another example,  $39 / 5$  is 7 because 5 goes into 39 seven whole times;  $38 / 5$ ,  $37 / 5$ ,  $36 / 5$ , and  $35 / 5$  all evaluate to 7.

The percent sign is the **remainder operator**. The remainder operator is most often used with two integers, and the result is an integer with the value of the remainder after division takes place. For example, the result of  $45 \% 2$  is 1 because 2 goes into 45 twenty-two times with a remainder of 1. Other examples of remainder operations include the following:

- $39 \% 5$  is 4 because 5 goes into 39 seven times with a remainder of 4.
- $20 \% 3$  is 2 because when 20 is divided by 3, the remainder is 2.  $36 \% 4$  is 0 because there is no remainder when 4 is divided into 36.



The remainder operator is also called the **modulus operator**, or sometimes just **mod**. Mathematicians would argue that *remainder* is the better term because in Java, the result of using the remainder operator can be negative, but in mathematics, the result of a modulus operation can never be negative. You also can perform remainder operations using floating-point values, but it is seldom useful to do so. In Java, when you use the `%` operator with floating-point values, the result is the remainder from a rounded division.

When you combine mathematical operations in a single statement, you must understand both associativity and precedence. The associativity of arithmetic operators with the same precedence is left to right. In a statement such as `answer = x + y + z;`, the `x` and `y` are added first, producing a temporary result, and then `z` is added to the temporary sum. After the sum is computed, the result is assigned to `answer`.

**Operator precedence** refers to the rules for the order in which parts of a mathematical expression are evaluated. The multiplication, division, and remainder operators have the same precedence. Their precedence is higher than that for the addition and subtraction operators. Addition and subtraction have the same precedence. In other words, multiplication, division, and remainder always take place from left to right prior to addition or subtraction in an expression. For example, the following statement assigns 14 to `result`:

```
int result = 2 + 3 * 4;
```

The multiplication operation ( $3 * 4$ ) occurs before adding 2. You can override normal operator precedence by putting the operation to perform first in parentheses. The following statement assigns 20 to `result`:

```
int result = (2 + 3) * 4;
```

The addition within the parentheses takes place first, and then the intermediate result (5) is multiplied by 4. When multiple pairs of parentheses are used in a statement, the innermost expression surrounded by parentheses is evaluated first. For example, the value of the following expression is 46:

```
2 * (3 + (4 * 5))
```



First,  $4 * 5$  evaluates to 20, and then 3 is added, giving 23. Finally, the value is multiplied by 2, giving 46.

Remembering that  $*$ ,  $/$ , and  $\%$  have the same precedence is important in arithmetic calculations. These operations are performed from left to right, regardless of the order in which they appear. For example, the value of the following expression is 9:

$25 / 8 * 3$

First, 25 is divided by 8. The result is 3 because with integer division, you lose any remainder. Then 3 is multiplied by 3, giving 9. If you assumed that  $*$  was performed before  $/$ , you would calculate an incorrect answer.



You will learn more about operator precedence in the chapter *Making Decisions*.

## Writing Arithmetic Statements Efficiently

You can make your programs operate more efficiently if you avoid unnecessary repetition of arithmetic statements. For example, suppose you know the values for an employee's hourly pay and pay rate and you want to compute state and federal withholding tax based on known rates. You could write two statements as follows:

```
stateWithholding = hours * rate * STATE_RATE;  
federalWithholding = hours * rate * FED_RATE;
```

With this approach, you perform the multiplication of  $\text{hours} * \text{rate}$  twice. It is more efficient to perform the calculation once, as follows:

```
grossPay = hours * rate;  
stateWithholding = grossPay * STATE_RATE;  
federalWithholding = grossPay * FED_RATE;
```

The time saved is very small, but these savings would be more important if the calculation was more complicated or if it was repeated many times in a program. As you think about the programs you write, remain on the lookout for ways to improve efficiency by avoiding duplication of operations.

## Pitfall: Not Understanding Imprecision in Floating-Point Numbers

Integer values are exact, but floating-point numbers frequently are only approximations. For example, when you divide 1.0 by 3.0, the mathematical result is 0.3333333..., with the 3s continuing infinitely. No matter how many decimal places you can store, the result is only an approximation. Even values that don't repeat indefinitely in our usual numbering system, such as 0.1, cannot be represented precisely in the binary format used by computers. Imprecision leads to several problems:



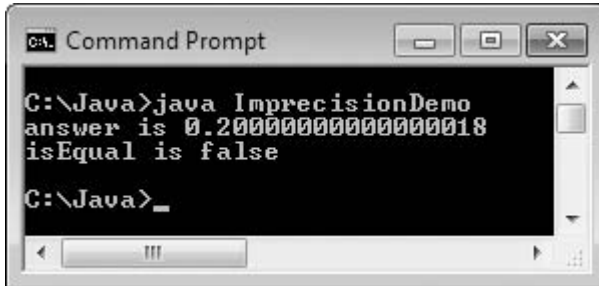
Appendix B provides a more thorough explanation of numbering systems and why fractional values cannot be represented accurately.

- When you produce floating-point output, it might not look like what you expect or want.
- When you make comparisons with floating-point numbers, the comparisons might not be what you expect or want.

For example, Figure 2-8 shows a class in which an answer is computed as  $2.20 - 2.00$ . Mathematically, the result should be  $0.20$ . But, as the output in Figure 2-9 shows, the result is calculated as a value that is slightly more than  $0.20$ , and when `answer` is compared to  $0.20$ , the result is `false`.

```
public class ImprecisionDemo
{
    public static void main(String[] args)
    {
        double answer = 2.20 - 2.00;
        boolean isEqual = answer == 0.20;
        System.out.println("answer is " + answer);
        System.out.println("isEqual is " + isEqual);
    }
}
```

**Figure 2-8** The `ImprecisionDemo` program



```
C:\Java>java ImprecisionDemo
answer is 0.200000000000000018
isEqual is false
C:\Java>_
```

**Figure 2-9** Execution of the `ImprecisionDemo` program

For now, you might choose to accept the slight imprecisions generated when you use floating-point numbers. However, if you want to eliminate the imprecisions, you can use one of several techniques to round values. Appendix C contains directions on how to round numbers and how to format a floating-point number so it displays the desired number of decimal positions.



Several movies have used the fact that floating-point numbers are not precise as a plot element. For example, in the movies *Superman III* and *Office Space*, thieves round currency values and divert the remaining fractions of cents to their own accounts.



Watch the video *Arithmetic*.

## TWO TRUTHS & A LIE

### Displaying Data and Performing Arithmetic

1. In Java, when a numeric value is concatenated to a `String` using the plus sign, the entire expression becomes a `String`.
2. The arithmetic operators are examples of unary operators, which are so named because they perform one operation at a time.
3. In Java, operator precedence dictates that multiplication, division, and remainder always take place prior to addition or subtraction in an expression.

The false statement is #2. The arithmetic operators are examples of binary operators, which are so named because they require two operands.

73

## Understanding Numeric Type Conversion

When you perform arithmetic with variables or constants of the same type, the result of the operation retains the same type. For example, when you divide two `ints`, the result is an `int`, and when you subtract two `doubles`, the result is a `double`. Often, however, you might want to perform mathematical operations on operands with unlike types.

When you perform arithmetic operations with operands of unlike types, Java chooses a unifying type for the result. The **unifying type** is the type to which all operands in an expression are converted so that they are compatible with each other. Java performs an **implicit conversion**; that is, it automatically converts nonconforming operands to the unifying type. Implicit conversions also are called **promotions**. The following list shows the order for establishing unifying types between values:

1. `double`
2. `float`
3. `long`
4. `int`

When two unlike types are used in an expression, the unifying type is the one with the lower number in this list. In other words, the operand that is a type with a higher number in this list is converted to the type of the one that has a lower number. For example, the addition of a `double` and an `int` results in a `double`, and the subtraction of a `long` from a `float` results in a `float`.



Boolean values cannot be converted to another type. In some languages, such as C++, Boolean values are actually numbers. However, this is not the case in Java.

For example, assume that an `int`, `hoursWorked`, and a `double`, `payRate`, are defined and then multiplied as follows:

```
int hoursWorked = 37;
double payRate = 6.73;
double grossPay = hoursWorked * payRate;
```

The result of the multiplication is a `double` because when a `double` and an `int` are multiplied, the `int` is promoted to the higher-ranking unifying type `double`—the type with the lower number in the preceding list. Therefore, assigning the result to `grossPay` is legal. The following code will not compile because Java does not allow the loss of precision that occurs if you try to store the calculated `double` result in an `int`.

```
int hoursWorked = 37;
double payRate = 6.73;
int grossPay = hoursWorked * payRate;
```



The data types `char`, `short`, and `byte` all are promoted to `int` when used in statements with unlike types. If you perform a calculation with any combination of `char`, `short`, and `byte` values, the result is an `int` by default. For example, if you add two `bytes`, the result is an `int`, not a `byte`.

You can explicitly (or purposely) override the unifying type imposed by Java by performing a type cast. **Type casting** forces a value of one data type to be used as a value of another type. To perform a type cast, you use a **cast operator**, which is created by placing the desired result type in parentheses. Using a cast operator is an **explicit conversion**. The cast operator is followed by the variable or constant to be cast. For example, a type cast is performed in the following code:

```
double bankBalance = 189.66;
float weeklyBudget = (float) (bankBalance / 4);
// weeklyBudget is 47.415, one-fourth of bankBalance
```



The cast operator is more completely called the **unary cast operator**. Unlike a binary operator that requires two operands, a **unary operator** uses only one operand. The unary cast operator is followed by its operand.

In this example, the `double` value `bankBalance` is divided by the integer `4`, and the result is a `double`. Then the `double` result is converted to a `float` before it is stored in `weeklyBudget`. Without the conversion, the statement that assigns the result to `weeklyBudget` would not compile. Similarly, a cast from a `float` to an `int` occurs in this code segment:

```
float myMoney = 47.82f;
int dollars = (int) myMoney;
// dollars is 47, the integer part of myMoney
```

In this example, the `float` value `myMoney` is converted to an `int` before it is stored in the integer variable named `dollars`. When the `float` value is converted to an `int`, the decimal place values are lost. The cast operator does not permanently alter any variable's data type; the alteration is only for the duration of the current operation.



The word `cast` is used in a similar fashion when referring to molding metal, as in *cast iron*. In a Java arithmetic cast, a value is “molded” into a different type.



It is easy to lose data when performing a cast. For example, the largest `byte` value is 127 and the largest `int` value is 2,147,483,647, so the following statements produce distorted results:

```
int anOkayInt = 200;
byte aBadByte = (byte)anOkayInt;
```



A `byte` is constructed from eight 1s and 0s, or binary digits. The first binary digit, or bit, holds a 0 or 1 to represent positive or negative. The remaining seven bits store the actual value. When the integer value 200 is stored in the `byte` variable, its large value consumes the eighth bit, turning it to a 1, and forcing the `aBadByte` variable to appear to hold the value `-72`, which is inaccurate and misleading.

You do not need to perform a cast when assigning a value to a higher unifying type. For example, when you write a statement such as the following, Java automatically promotes the integer constant 10 to be a `double` so that it can be stored in the `payRate` variable:

```
double payRate = 10;
```

However, for clarity, if you want to assign 10 to `payRate`, you might prefer to write the following:

```
double payRate = 10.0;
```

The result is identical to the result when you assign the literal integer 10 to the `double` variable.

### TWO TRUTHS & A LIE

#### Understanding Numeric Type Conversion

1. When you perform arithmetic operations with operands of unlike types, you must make an explicit conversion to a unifying type.
2. Summing a `double`, `int`, and `float` results in a `double`.
3. You can explicitly override the unifying type imposed by Java by performing a type cast; type casting forces a value of one data type to be used as a value of another type.

The false statement is #1. When you perform arithmetic operations with operands of unlike types, Java performs an implicit conversion to a unifying type.

## Using the Scanner Class for Keyboard Input

In Chapter 1, you learned how to display output on the monitor using the `System.out` property. `System.out` refers to the standard output device, which usually is the monitor. Frequently you also want to create interactive programs that accept input from a user. To do so, you can use `System.in`, which refers to the **standard input device** (normally the keyboard).

You can use the `print()` and `println()` methods to display many data types; for example, you can use them to display a `double`, `int`, or `String`. The `System.in` object is not as flexible; it is designed to read only bytes. That's a problem, because you often want to accept data of other types. Fortunately, the designers of Java have created a class named `Scanner` that makes `System.in` more flexible.

To create a `Scanner` object and connect it to the `System.in` object, you write a statement similar to the following:

```
Scanner inputDevice = new Scanner(System.in);
```

The portion of the statement to the left of the assignment operator, `Scanner inputDevice`, declares an object of type `Scanner` with the programmer-chosen name `inputDevice`, in exactly the same way that `int x`; declares an integer with the programmer-chosen name `x`.

The portion of the statement to the right of the assignment operator, `new Scanner(System.in)`, creates a `Scanner` object that is connected to the `System.in` property. In other words, the created `Scanner` object is connected to the default input device. The keyword `new` is required by Java; you will use it whenever you create objects that are more complex than the simple data types.



In the chapter *More Object Concepts*, you will learn that the second part of the `Scanner` declaration calls a special method called a constructor that is part of the prewritten `Scanner` class. You also will learn more about the Java keyword `new` in the next two chapters.

The assignment operator in the `Scanner` declaration statement assigns the value of the new object—that is, its memory address—to the `inputDevice` object in the program.

A `Scanner` object breaks its input into units called **tokens**, separating them when it encounters whitespace. The resulting tokens can then be converted into values of different types using the various class methods. Table 2-8 summarizes some of the most useful methods that read different data types from the default input device. Each retrieves a value from the keyboard and returns it as the appropriate data type. The appropriate method executes, retrieving data when a user presses an appropriate whitespace key at the keyboard. The `nextLine()` method does not retrieve data until the user presses Enter; the other methods retrieve data when the user presses Enter, the spacebar, or the tab key.

Method	Description
<code>nextDouble()</code>	Retrieves input as a <code>double</code>
<code>nextInt()</code>	Retrieves input as an <code>int</code>
<code>nextLine()</code>	Retrieves the next line of data and returns it as a <code>String</code>
<code>next()</code>	Retrieves the next complete token as a <code>String</code>

**Table 2-8** Selected Scanner class methods



In addition to the methods listed in Table 2-8, the `Scanner` class contains methods called `nextByte()`, `nextFloat()`, `nextLong()`, and `nextShort()` that work as you would expect based on their identifiers.



The `Scanner` class does not contain a `nextChar()` method. To retrieve a single character from the keyboard, you can use the `nextLine()` method and then use the `charAt()` method. The chapter *Characters, Strings, and the `StringBuilder`* provides more details about the `charAt()` method.

Figure 2-10 contains a program that uses two of the `Scanner` class methods. The program reads a string and an integer from the keyboard and displays them. The `Scanner` class is used in the four shaded statements in the figure.

- The first shaded statement is `import java.util.Scanner;`. This statement imports the package necessary to use the `Scanner` class.
- The second shaded statement declares a `Scanner` object named `inputDevice`.
- The third shaded statement uses the `nextLine()` method to retrieve a line of text from the keyboard and store it in the `name` variable.
- The last shaded statement uses the `nextInt()` method to retrieve an integer from the keyboard and store it in the `age` variable.

Figure 2-11 shows a typical execution of the program.

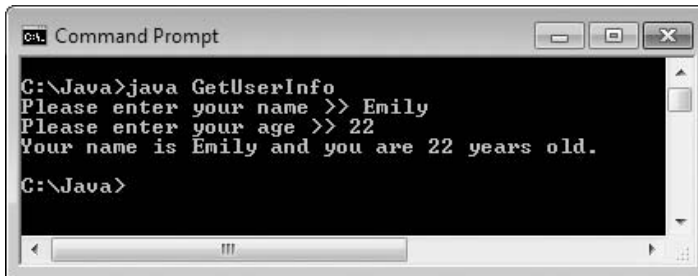


Java programmers would say that the `Scanner` methods *return* the appropriate value. That also means that the value of the method is the appropriate value, and that you can assign the returned value to a variable, display it, or use it in other legal statements. In the chapter *Using Methods, Classes, and Objects*, you will learn how to write your own methods that return values.

```
import java.util.Scanner;
public class GetUserInfo
{
    public static void main(String[] args)
    {
        String name;
        int age;
        Scanner inputDevice = new Scanner(System.in);
        System.out.print("Please enter your name >> ");
        name = inputDevice.nextLine();
        System.out.print("Please enter your age >> ");
        age = inputDevice.nextInt();
        System.out.println("Your name is " + name +
            " and you are " + age + " years old.");
    }
}
```

Repeating as output what a user has entered as input is called **echoing the input**. Echoing input is a good programming practice; it helps eliminate misunderstandings when the user can visually confirm what was entered.

Figure 2-10 The GetUserInfo class



```
C:\Java>java GetUserInfo
Please enter your name >> Emily
Please enter your age >> 22
Your name is Emily and you are 22 years old.
C:\Java>
```

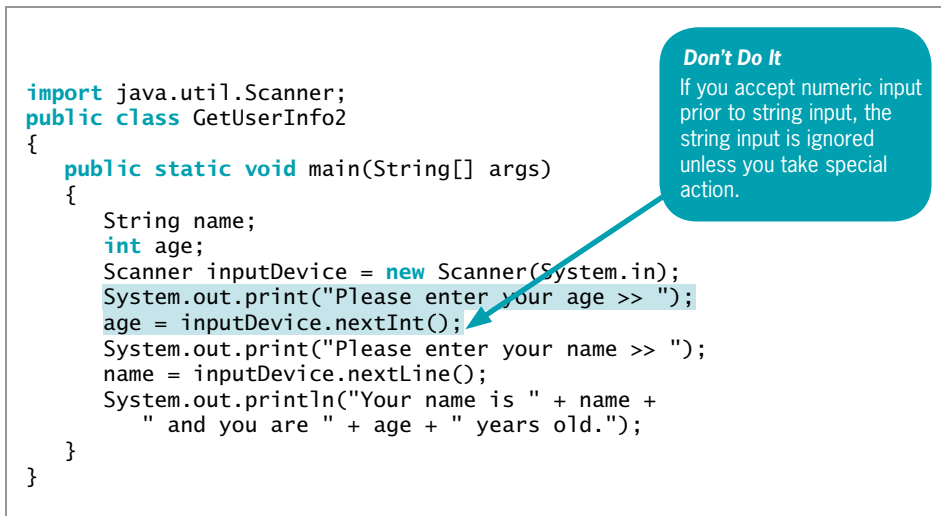
Figure 2-11 Typical execution of the GetUserInfo program

The `print()` statements that appear before each input statement in the program in Figure 2-10 are examples of prompts. A **prompt** is a message displayed for the user that requests and describes input. Interactive programs would work without prompts, but they would not be as user-friendly. Each prompt in the `GetUserInfo` class ends with two greater-than signs and a space. This punctuation is not required; it just separates the words in the prompt from the user's input value on the screen, improving readability.

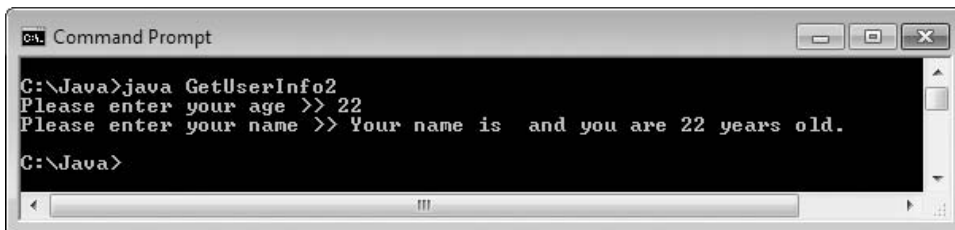
## Pitfall: Using `nextLine()` Following One of the Other Scanner Input Methods

You can encounter a problem when you use one of the numeric `Scanner` class retrieval methods or the `next()` method before you use the `nextLine()` method. Consider the program in Figure 2-12. It is identical to the one in Figure 2-10, except that the user is asked for an age before being asked for a name. (See shading.) Figure 2-13 shows a typical execution.





**Figure 2-12** The GetUserInfo2 class



**Figure 2-13** Typical execution of the GetUserInfo2 program

In Figure 2-13, the user is prompted correctly for an age. However, after the user enters an age and the prompt for the name is displayed, the program does not pause to let the user enter a name. Instead, the program proceeds directly to the output statement, which does not contain a valid name, as you can see in Figure 2-13.

When you type characters using the keyboard, they are stored temporarily in a location in memory called the **keyboard buffer**. The keyboard buffer sometimes is called the **type-ahead buffer**. All keystrokes are stored in the keyboard buffer, including the Enter key. The problem occurs because of a difference in the way the `nextLine()` method and the other Scanner retrieval methods work:

- The Scanner methods `next()`, `nextInt()`, and `nextDouble()` retrieve the next token in the buffer up to the next whitespace, which might be a space, tab, or Enter key.
- The `nextLine()` method reads all data up to the Enter key character.

So, in the execution of the program in Figure 2-13, the user is prompted for an age, types 22, and presses Enter. The call to the `nextInt()` method retrieves the 22 and leaves the Enter key

press in the input buffer. Then the name prompt is displayed and the call to `nextLine()` retrieves the waiting Enter key before the user can type a name.

The solution to the problem is simple. After any `next()`, `nextInt()`, or `nextDouble()` call, you can add an extra `nextLine()` method call that will retrieve the abandoned Enter key character. Then, no matter what type of input follows, the program will execute smoothly. Figure 2-14 shows a program that contains just one change from Figure 2-12—the addition of the shaded statement that retrieves the abandoned Enter key character from the input buffer. Although you could assign the Enter key to a character variable, there is no need to do so. When you accept an entry and discard it without using it, programmers say that the entry is **consumed**. Figure 2-14 shows that the call to `nextInt()` accepts the integer, the first call to `nextLine()` accepts the Enter key that follows the integer entry, and the second `nextLine()` call accepts both the entered name and the Enter key that follows it. Figure 2-15 shows that the revised program executes correctly.

```
import java.util.Scanner;
public class GetUserInfo3
{
    public static void main(String[] args)
    {
        String name;
        int age;
        Scanner inputDevice = new Scanner(System.in);
        System.out.print("Please enter your age >> ");
        age = inputDevice.nextInt();
        inputDevice.nextLine();
        System.out.print("Please enter your name >> ");
        name = inputDevice.nextLine();
        System.out.println("Your name is " + name +
            " and you are " + age + " years old.");
    }
}
```

This statement gets the integer.

This statement consumes the Enter key that follows the integer.

This statement gets the name and discards the Enter key that follows the name.

Figure 2-14 The `GetUserInfo3` class



```
ca. Command Prompt
C:\Java>java GetUserInfo3
Please enter your age >> 22
Please enter your name >> Emily
Your name is Emily and you are 22 years old.
C:\Java>_
```

Figure 2-15 Typical execution of the `GetUserInfo3` program



When you write programs that accept user input, there is a risk that the user will enter the wrong type of data. For example, if you include a `nextInt()` method call in your program, but the user types an alphabetic character, an error will occur and your program will stop running. You will learn to handle this type of error later in this book.

## TWO TRUTHS & A LIE

### Using the `Scanner` Class for Keyboard Input

1. `System.in` refers to the standard input device, which normally is the keyboard.
2. `System.in` is more flexible than `System.out` because it can read all the basic Java data types.
3. When a user types data followed by the Enter key, the Enter key character is left in the keyboard buffer after `Scanner` class methods retrieve the other keystrokes.

The false statement is #2. `System.in` is not as flexible as `System.out`. `System.out` can display various data types, but `System.in` is designed to read only bytes.

## Using the `JOptionPane` Class for GUI Input

In Chapter 1, you learned how to display output at the command line and how to create GUI message boxes to display `String` objects. Earlier in this chapter, you learned to accept input from the keyboard at the command line. You also can accept input in a GUI dialog box using the `JOptionPane` class.

Two dialog boxes that can be used to accept user input are:

- `InputDialog`—Prompts the user for text input
- `ConfirmDialog`—Asks the user a question, providing buttons that the user can click for Yes, No, and Cancel responses

### Using Input Dialog Boxes

An **input dialog box** asks a question and provides a text field in which the user can enter a response. You can create an input dialog box using the **`showInputDialog()` method**. Six overloaded versions of this method are available, but the simplest version uses a single argument that is the prompt you want to display within the dialog box. The `showInputDialog()` method returns a `String` that represents a user's response; this means that you can assign the `showInputDialog()` method to a `String` variable and the variable will hold the value that the user enters.



Earlier in this chapter you learned that `println()` also is an overloaded method. Recall that when a method is overloaded, it has multiple versions with the same name that can be used with a variety of options.

For example, Figure 2-16 shows an application that creates an input dialog box containing a prompt for a first name. When the user executes the application, types *Audrey*, then clicks the OK button or presses Enter on the keyboard, the response `String` will contain *Audrey*. In the application in Figure 2-16, the response is concatenated with a welcoming message and displayed in a message dialog box. Figure 2-17 shows the dialog box containing a user's response, and Figure 2-18 shows the resulting output message box.

```
import javax.swing.JOptionPane;
public class HelloNameDialog
{
    public static void main(String[] args)
    {
        String result;
        result = JOptionPane.showInputDialog(null, "What is your name?");
        JOptionPane.showMessageDialog(null, "Hello, " + result + "!");
    }
}
```

**Figure 2-16** The `HelloNameDialog` class

Within the `JOptionPane` class, an overloaded version of the `showInputDialog()` method allows the programmer flexibility in controlling the appearance of the input dialog box. The version of `showInputDialog()` that requires four arguments can be used to display a title in the dialog box title bar and a message that describes the type of dialog box. The four arguments to `showInputDialog()` include:

- The parent component, which is the screen component, such as a frame, in front of which the dialog box will appear. If this argument is null, the dialog box is centered on the screen.



**Figure 2-17** Input dialog box of the `HelloNameDialog` application



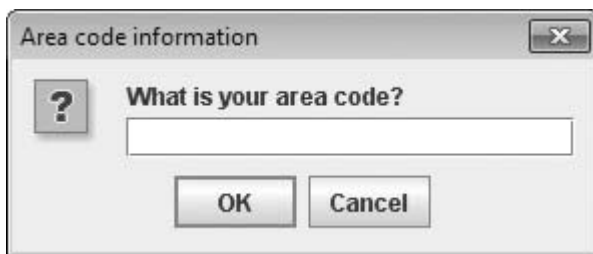
**Figure 2-18** Output of the `HelloNameDialog` application

- The message the user will see before entering a value. Usually this message is a `String`, but it actually can be any type of object.
- The title to be displayed in the title bar of the input dialog box.
- A class field describing the type of dialog box; it can be one of the following: `ERROR_MESSAGE`, `INFORMATION_MESSAGE`, `PLAIN_MESSAGE`, `QUESTION_MESSAGE`, or `WARNING_MESSAGE`.

For example, when the following statement executes, it displays the input dialog box shown in Figure 2-19.

```
JOptionPane.showInputDialog(null,
    "What is your area code?",
    "Area code information",
    JOptionPane.QUESTION_MESSAGE);
```

Note that the title bar displays “Area code information,” and the dialog box shows a question mark icon.



**Figure 2-19** An input dialog box with a `String` in the title bar and a question mark icon

The `showInputDialog()` method returns a `String` object, which makes sense when you consider that you might want a user to type any combination of keystrokes into the dialog box. However, when the value that the user enters is intended to be used as a number, as in an arithmetic statement, the returned `String` must be converted to the correct numeric type. Earlier in this chapter, you learned how to cast a value from one data type to another. However, casting data only works with primitive data types—`double`, `int`, `char`, and so on—not with class objects (that are reference types) such as a `String`. To convert a `String` to an `integer` or `double`, you must use methods from the built-in Java classes `Integer` and `Double`. Each primitive type in Java has a corresponding class contained in the `java.lang` package; like most classes, the names of these classes begin with uppercase letters. These classes are called **type-wrapper classes**. They include methods that can process primitive type values.

Figure 2-20 shows a `SalaryDialog` application that contains two `String` objects—`wageString` and `dependentsString`. Two `showInputDialog()` methods are called, and the answers are stored in the declared `Strings`. The shaded statements in Figure 2-20 show how the `Strings` are converted to numeric values using methods from the type-wrapper classes `Integer` and `Double`. The `double` value is converted using the `Double.parseDouble()`

method, and the integer is converted using the `Integer.parseInt()` method. Figure 2-21 shows a typical execution of the application.



Remember that in Java, the reserved keyword `static` means that a method is accessible and usable even though no objects of the class exist. You can tell that the method `Double.parseDouble()` is a `static` method, because the method name is used with the class name `Double`—no object is needed. Similarly, you can tell that `Integer.parseInt()` is also a `static` method.

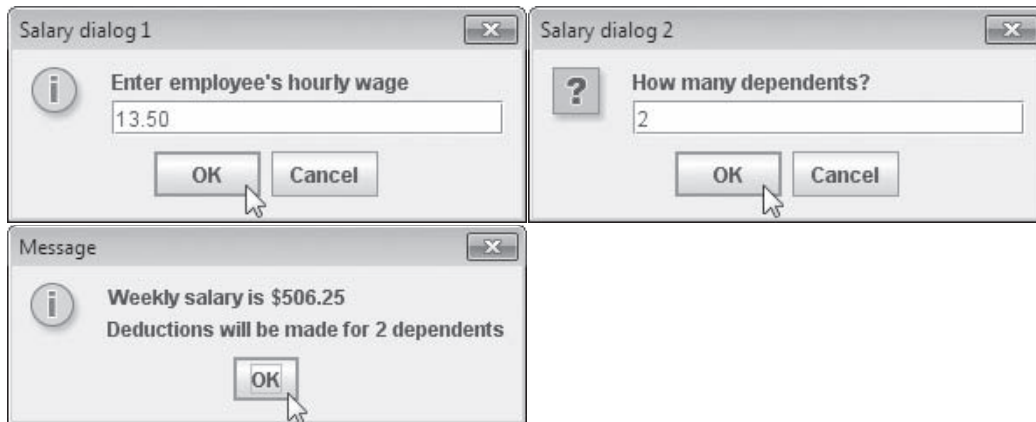
84



The term **parse** means to break into component parts. Grammarians talk about “parsing a sentence”—deconstructing it so as to describe its grammatical components. Parsing a `String` converts it to its numeric equivalent.

```
import javax.swing.JOptionPane;
public class SalaryDialog
{
    public static void main(String[] args)
    {
        String wageString, dependentsString;
        double wage, weeklyPay;
        int dependents;
        final double HOURS_IN_WEEK = 37.5;
        wageString = JOptionPane.showInputDialog(null,
            "Enter employee's hourly wage", "Salary dialog 1",
            JOptionPane.INFORMATION_MESSAGE);
        weeklyPay = Double.parseDouble(wageString) *
            HOURS_IN_WEEK;
        dependentsString = JOptionPane.showInputDialog(null,
            "How many dependents?", "Salary dialog 2",
            JOptionPane.QUESTION_MESSAGE);
        dependents = Integer.parseInt(dependentsString);
        JOptionPane.showMessageDialog(null, "Weekly salary is $" +
            weeklyPay + "\nDeductions will be made for " +
            dependents + " dependents");
    }
}
```

Figure 2-20 The `SalaryDialog` class



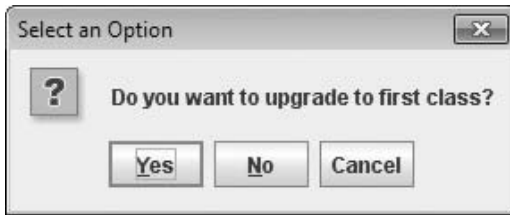
**Figure 2-21** Sample execution of the SalaryDialog application

## Using Confirm Dialog Boxes

Sometimes, the input you want from a user does not have to be typed from the keyboard. When you present simple options to a user, you can offer buttons that the user can click to confirm a choice. A **confirm dialog box** displays the options Yes, No, and Cancel; you can create one using the **showConfirmDialog()** method in the JOptionPane class. Four overloaded versions of the method are available; the simplest requires a parent component (which can be null) and the String prompt that is displayed in the box. The showConfirmDialog() method returns an integer containing one of three possible values: JOptionPane.YES\_OPTION, JOptionPane.NO\_OPTION, or JOptionPane.CANCEL\_OPTION. Figure 2-22 shows an application that asks a user a question. The shaded statement displays the dialog box shown in Figure 2-23 and stores the user's response in the integer variable named selection.

```
import javax.swing.JOptionPane;
public class AirlineDialog
{
    public static void main(String[] args)
    {
        int selection;
        boolean isYes;
        selection = JOptionPane.showConfirmDialog(null,
            "Do you want to upgrade to first class?");
        isYes = (selection == JOptionPane.YES_OPTION);
        JOptionPane.showMessageDialog(null,
            "You responded " + isYes);
    }
}
```

**Figure 2-22** The AirlineDialog class



**Figure 2-23** The confirm dialog box displayed by the `AirlineDialog` application

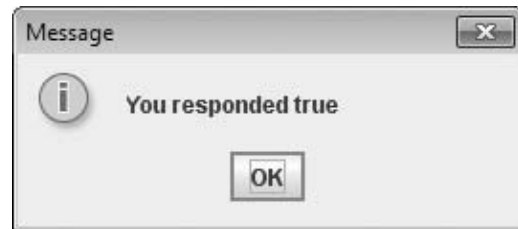
After a value is stored in `selection`, a Boolean variable named `isYes` is set to the result when `selection` and `JOptionPane.YES_OPTION` are compared. If the user has selected the Yes button in the dialog box, this variable is set to `true`; otherwise, the variable is set to `false`. Finally, the true or false result is displayed; Figure 2-24 shows the result when a user clicks the Yes button in the dialog box.

You can also create a confirm dialog box with five arguments, as follows:

- The parent component, which can be null
- The prompt message
- The title to be displayed in the title bar
- An integer that indicates which option button will be shown (It should be one of the class variables `YES_NO_CANCEL_OPTION` or `YES_NO_OPTION`.)
- An integer that describes the kind of dialog box (It should be one of the class variables `ERROR_MESSAGE`, `INFORMATION_MESSAGE`, `PLAIN_MESSAGE`, `QUESTION_MESSAGE`, or `WARNING_MESSAGE`.)

When the following statement is executed, it displays a confirm dialog box, as shown in Figure 2-25:

```
JOptionPane.showConfirmDialog(null,  
    "A data input error has occurred. Continue?",  
    "Data input error", JOptionPane.YES_NO_OPTION,  
    JOptionPane.ERROR_MESSAGE);
```



**Figure 2-24** Output of `AirlineDialog` application when user clicks Yes



Note that the title bar displays “Data input error,” the Yes and No buttons appear, and the dialog box shows the error message, “A data input error has occurred. Continue?” It also displays the octagonal ERROR\_MESSAGE icon.



Confirm dialog boxes provide more practical uses when your applications can make decisions based on the users' responses. In the chapter *Making Decisions*, you will learn how to make decisions within programs.

**Figure 2-25** Confirm dialog box with title, Yes and No buttons, and error icon

## TWO TRUTHS & A LIE

### Using the JOptionPane Class for GUI Input

1. You can create an input dialog box using the `showInputDialog()` method; the method returns a `String` that represents a user's response.
2. Casting data only works with primitive data types and not with reference types such as `String`. You must use methods from the Java classes `Integer` and `Double` when you want to convert a dialog box's returned values to numbers.
3. A confirm dialog box can be created using the `showConfirmDialog()` method in the `JOptionPane` class; a confirm dialog box displays the options `Accept`, `Reject`, and `Escape`.

The false statement is #3. A confirm dialog box displays the options Yes, No, and Cancel.



Watch the video *Getting Input*.

## You Do It

### Working with Numeric Values

In this section, you will write an application to declare and display numeric values.

#### To declare and display an integer value in an application:

1. Open a new document in your text editor. Create a class header and an opening and closing curly brace for a new class named **DemoVariables** by typing the following:

```
public class DemoVariables
{
}
```

2. Indent a few spaces on the next line and type the following `main()` method header and its curly braces:

```
public static void main(String[] args)
{
}
```



Some programmers use the Tab key to indent lines; others use spaces. Tabs can pose a problem when your code is opened in an editor that is configured differently from the one in which you wrote the source code originally. This book will use three spaces as the standard indentation, but you might prefer two, four, or five spaces in your programs.

3. Between the `main()` method's curly braces, type the following variable declaration:  
**`int entry = 315;`**



You can declare variables at any point within a method prior to their first use. However, it is common practice to declare variables first in a class, and to place executable statements after them.

4. Type the following two output statements. The first statement uses the `print()` method to output "The entry is " and leaves the insertion point on the same output line. The space before the closing quotation mark creates a space between the literal string and the displayed value in the second statement. The second statement uses the `println()` method instead of `print()` so that the insertion point advances to a new line after `entry` is displayed.

```
System.out.print("The entry is ");
System.out.println(entry);
```

5. Save the file as **DemoVariables.java**.
6. Compile the file from the command line by typing **`javac DemoVariables.java`**. If necessary, correct any errors, save the file, and then compile again.
7. Execute the application from the command line by typing **`java DemoVariables`**. The command window output is shown in Figure 2-26.

```
Command Prompt
C:\Java>java DemoVariables
The entry is 315
C:\Java>_
```

**Figure 2-26** Output of the `DemoVariables` application

## Accepting User Data

A program that displays the same value each time it executes is not as useful as one that can accept and display a user's entered value.

### To accept user data in the application:

89

1. Return to the **DemoVariables.java** file in the text editor. Rename the class **DemoVariables2**. Immediately save the file as **DemoVariables2.java**. When you modify a file by changing its class name, it is a good idea to save the file with the corresponding new name immediately. Otherwise, it is easy to forget that you have not saved the changes, and when you choose *Save*, you inadvertently write over the previous file version with the old class name.
2. At the top of the file, as the first line, type the statement that will allow you to use the `Scanner` class for data entry:

```
import java.util.Scanner;
```

3. Remove the value assigned to `entry` so that the declaration becomes:
4. After the declaration of `entry`, add a declaration for a `Scanner` object that can be used to accept data entry from the keyboard:

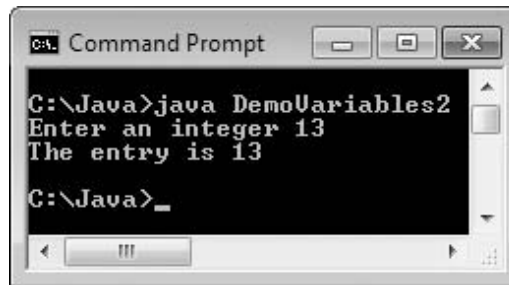
```
Scanner keyBoard = new Scanner(System.in);
```

5. On the next two lines, add a prompt that asks the user to enter an integer and write the statement that accepts the user's entry:

```
System.out.print("Enter an integer ");  
entry = keyBoard.nextInt();
```

6. Save the application, then compile it by typing **javac DemoVariables2.java** at the command line. If necessary, correct any errors, save the file, and then compile again.

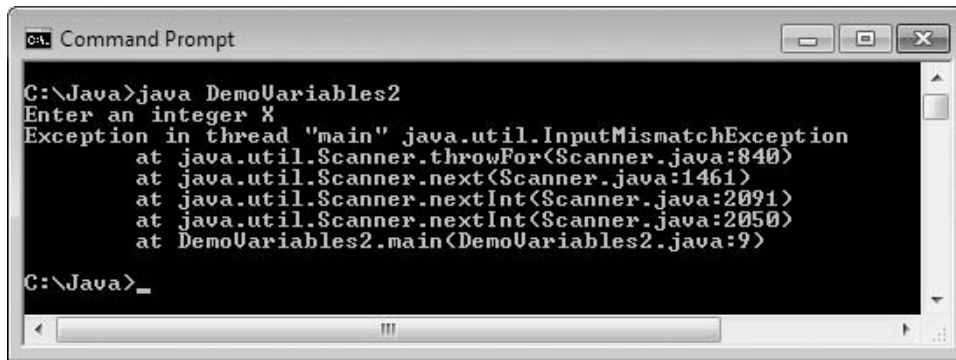
7. Execute the application by typing **java DemoVariables2**. When the prompt appears on the screen, enter an integer. Figure 2-27 shows a typical execution.



```
C:\Java>java DemoVariables2  
Enter an integer 13  
The entry is 13  
C:\Java>_
```

8. Execute the program several times using different values, including negative numbers, and confirm that the program works as expected. Then execute the program and type an invalid entry—for example, an integer that is too large, a floating-point value, or a letter of the alphabet. Figure 2-28 shows the error messages generated when the user types something other than an integer.

**Figure 2-27** Output of the `DemoVariables2` application



```
C:\Java>java DemoVariables2
Enter an integer X
Exception in thread "main" java.util.InputMismatchException
    at java.util.Scanner.throwFor(Scanner.java:840)
    at java.util.Scanner.next(Scanner.java:1461)
    at java.util.Scanner.nextInt(Scanner.java:2091)
    at java.util.Scanner.nextInt(Scanner.java:2050)
    at DemoVariables2.main(DemoVariables2.java:9)

C:\Java>_
```

**Figure 2-28** Error messages generated when the user enters an “X” into the `DemoVariables2` program

As you write Java programs in this chapter and the next few chapters, you are likely to make similar data-entry mistakes. The messages in Figure 2-28 might look intimidating, but you should remember two points:

- First, if you read the messages carefully, you will find they provide some useful information. The last line of the message indicates that the problem occurred in line 9 of the `DemoVariables2` program. In the source code file, line 9 is the one that attempts to get the next integer from the keyboard. This provides a clue that a problem occurred with data entry.
- Second, you can ignore the messages and simply rerun the program. When you enter valid data, the program will work as expected—you haven’t “broken” anything.

## Performing Arithmetic

In the next steps, you will accept an additional value into your program and perform arithmetic operations on the entered values.

### To add another variable and perform arithmetic:

1. Open the `DemoVariables2.java` text file, and rename the class `DemoVariables3`. Immediately save it as `DemoVariables3.java`.
2. After the declaration of `entry`, add a declaration for a second variable:  

```
int anotherEntry;
```
3. Following the existing statements that prompt for and receive a value for `anotherEntry`, add two statements that prompt for and receive the newly declared integer:  

```
System.out.print("Enter another integer ");  
anotherEntry = keyBoard.nextInt();
```

- At the end of the `main()` method, after the statement that displays the value of `entry` and just before the closing curly brace for the method, add statements that display the second entered value:

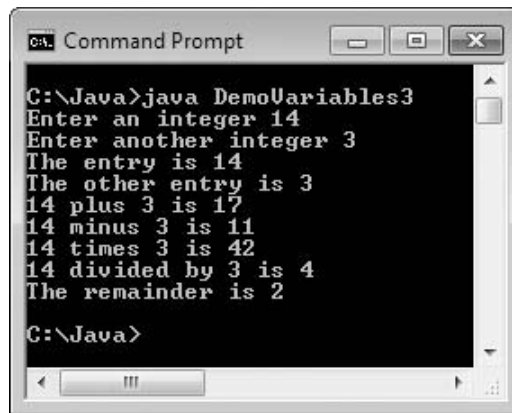
```
System.out.print("The other entry is ");
System.out.println(anotherEntry);
```

- Add some statements that perform arithmetic operations on the two entered values.

```
System.out.println(entry + " plus " +
    anotherEntry + " is " + (entry + anotherEntry));
System.out.println(entry + " minus " +
    anotherEntry + " is " + (entry - anotherEntry));
System.out.println(entry + " times " +
    anotherEntry + " is " + (entry * anotherEntry));
System.out.println(entry + " divided by " +
    anotherEntry + " is " + (entry / anotherEntry));
System.out.println("The remainder is " +
    (entry % anotherEntry));
```

- Save the file, then compile and test the application several times using different input values. A typical execution is shown in Figure 2-29.

- Make sure to execute the `DemoVariables3` program a few times using negative values for one or both of the integers. Notice that the remainder value is affected only by the sign of the first operand in the remainder statement, and not by the second.



```

C:\Java>java DemoVariables3
Enter an integer 14
Enter another integer 3
The entry is 14
The other entry is 3
14 plus 3 is 17
14 minus 3 is 11
14 times 3 is 42
14 divided by 3 is 4
The remainder is 2
C:\Java>
```

**Figure 2-29** Output of the `DemoVariables3` application

## Experimenting with Java Programs

Next, you will experiment with the program you have created to get a better understanding of variables and arithmetic.

### To get a better understanding of Java:

- Open the `DemoVariables3.java` file in your text editor, and change the class name to `DemoVariables4`. Immediately save the file as `DemoVariables4.java`.
- Remove the parentheses surrounding `entry + anotherEntry` in the statement that displays the sum of the two input values. Save, compile, and execute the program. What is the output?

3. Open the **DemoVariables3.java** file in your text editor (not `DemoVariables4.java`), and change the class name to **DemoVariables5**. Immediately save the file as **DemoVariables5.java**.
4. Remove the parentheses surrounding `entry * anotherEntry` in the statement that displays the product of the two input values. Save, compile, and execute the program. What is the significant difference between this example and the one from Step 2? Why?
5. Open the **DemoVariables3.java** file in your text editor, and change the class name to **DemoVariables6**. Immediately save the file as **DemoVariables6.java**. Change the data types of the two variables to `double`. Change the two prompts to ask the user for a `double` instead of an integer. Change the two instances of `nextInt()` to `nextDouble()`. Save, compile, and execute the program several times, entering floating-point values when prompted. Notice the slight imprecisions that occur with floating-point arithmetic. Study the remainder figure and see if you can determine what it means. Execute the program and enter integers, and notice that the program works appropriately because the integers are cast to `doubles`.
6. Open the **DemoVariables3.java** file in your text editor, and change the class name to **DemoVariables7**. Immediately save the file as **DemoVariables7.java**. Following the two existing variable declarations, declare a `String` as follows:

```
String name;
```

7. Just before the closing curly brace for the `main()` method, add the following statements that prompt a user for a name, accept it, and display it:

```
System.out.print("Enter your name ");  
name = keyboard.nextLine();  
System.out.println("Goodbye, " + name);
```

8. Save, compile, and execute the program. After you enter the requested integers and the arithmetic results are displayed, you are not given the chance to enter a name. That's because the `nextLine()` method accepts the Enter key that remained in the input buffer after the last number was entered. To remedy the situation, add the following statement after the statement that gets the last number:

```
keyboard.nextLine();
```

9. Save, compile, and execute the program. This time, you are able to enter a name, and the program executes as expected.

## Don't Do It

- Don't mispronounce *integer*. People who are unfamiliar with the term often say *interger*, inserting an extra *r*.
- Don't attempt to assign a literal constant floating-point number, such as 2.5, to a `float` without following the constant with an uppercase or lowercase `F`. By default, constant floating-point values are `doubles`.

- Don't forget precedence rules when you write statements that contain multiple arithmetic operations. For example, `score1 + score2 / 2` does not compute the average of two scores. Instead, it adds half of `score2` to `score1`. To compute the average, you would write `(score1 + score2) / 2`.
- Don't forget that integer division results in an integer, dropping any fractional part. For example, `1 / 2` is not equal to `0.5`; it is equal to `0`.
- Don't forget that floating-point numbers are imprecise.
- Don't attempt to assign a constant decimal value to an integer using a leading 0. For example, if you declare `int num = 021;` and then display `num`, you will see `17`. The leading 0 indicates that the value is in base 8 (octal), so its value is two 8s plus one 1. In the decimal system, `21` and `021` mean the same thing, but not in Java.
- Don't use a single equal sign (`=`) in a Boolean comparison for equality. The operator used for equivalency is composed of two equal signs (`==`).
- Don't try to store a string of characters, such as a name, in a `char` variable. A `char` variable can hold only a single character.
- Don't forget that when a `String` and a numeric value are concatenated, the resulting expression is a string. For example, `"X" + 2 + 4` results in `"X24"`, *not* `"X6"`. If you want the result to be `"X6"`, you can use the expression `"X" + (2 + 4)`.
- Don't forget to consume the Enter key after numeric input using the `Scanner` class when a `nextLine()` method call follows.
- Don't forget to use the appropriate `import` statement when using the `Scanner` or `JOptionPane` class.

## Key Terms

**Constant** describes values that cannot be changed during the execution of an application.

A **literal constant** is a value that is taken literally at each use.

A **numeric constant** is a number whose value is taken literally at each use.

An **unnamed constant** has no identifier associated with it.

A **variable** is a named memory location that you can use to store a value.

An item's **data type** describes the type of data that can be stored there, how much memory the item occupies, and what types of operations can be performed on the data.

A **primitive type** is a simple data type. Java's primitive types are `byte`, `short`, `int`, `long`, `float`, `double`, `char`, and `boolean`.

**Reference types** are complex data types that are constructed from primitive types.

A **variable declaration** is a statement that reserves a named memory location.

A **strongly typed language** is one in which all variables must be declared before they can be used.

**Camel casing** is a style in which an identifier begins with a lowercase letter and subsequent words within the identifier are capitalized.

The **assignment operator** is the equal sign (`=`); any value to the right of the equal sign is assigned to the variable on the left of the equal sign.

An **initialization** is an assignment made when you declare a variable.

An **assignment** is the act of providing a value for a variable.

**Associativity** refers to the order in which operands are used with operators.

An **lvalue** is an expression that can appear on the left side of an assignment statement.

An **rvalue** is an expression that can appear only on the right side of an assignment statement.

A **garbage value** is the unknown value stored in an uninitialized variable.

A **named constant** is a memory location whose value cannot change during program execution.

A **symbolic constant** is a named constant.

The keyword **final** precedes named constant declarations.

A **blank final** is a `final` variable that has not yet been assigned a value.

A **magic number** is a value that does not have immediate, intuitive meaning or a number that cannot be explained without additional knowledge. Unnamed constants are magic numbers.

The **scope** of a data item is the area in which it is visible to a program and in which you can refer to it using its simple identifier.

An **integer** is a whole number without decimal places.

The data type **int** is used to declare variables and constants that store integers.

The **byte** data type holds very small integers, from `-128` to `127`.

The **short** data type holds small integers, from `-32,768` to `32,767`.

The **long** data type holds very large integers, from `-9,223,372,036,854,775,808` to `9,223,372,036,854,775,807`.

A **boolean variable** can hold only one of two values—`true` or `false`.

A **relational operator** compares two items; an expression that contains a relational operator has a Boolean value.

A **comparison operator** is another name for a relational operator.

A **floating-point** number contains decimal positions.



A **float** data type can hold a floating-point value of up to six or seven significant digits of accuracy.

A **double** data type can hold a floating-point value of up to 14 or 15 significant digits of accuracy.

The term **significant digits** refers to the mathematical accuracy of a value.

**Scientific notation** is a display format that more conveniently expresses large or small numeric values; a multidigit number is converted to a single-digit number and multiplied by 10 to a power.

A **double-precision floating-point number** is stored in a `double`.

A **single-precision floating-point number** is stored in a `float`.

The **char** data type is used to hold any single character.

**String** is a built-in Java class that provides you with the means for storing and manipulating character strings.

An **escape sequence** begins with a backslash followed by a character; the pair represents a single character.

**Concatenated** describes values that are attached end to end.

A **null String** is an empty `String` created by typing a set of quotes with nothing between them.

**Arithmetic operators** are used to perform calculations with values.

An **operand** is a value used in an arithmetic statement.

**Binary operators** require two operands.

**Floating-point division** is the operation in which two values are divided and either or both are floating-point values.

**Integer division** is the operation in which two values are divided and both are integers; the result contains no fractional part.

The **remainder operator** is the percent sign; when it is used with two integers, the result is an integer with the value of the remainder after division takes place.

The **modulus operator**, sometimes abbreviated as **mod**, is an alternate name for the remainder operator.

**Operator precedence** is the rules for the order in which parts of a mathematical expression are evaluated.

A **unifying type** is a single data type to which all operands in an expression are converted.

An **implicit conversion** is the automatic transformation of one data type to another.

**Promotion** is an implicit conversion.

**Type casting** forces a value of one data type to be used as a value of another type.

A **cast operator** performs an explicit type conversion; it is created by placing the desired result type in parentheses before the expression to be converted.

An **explicit conversion** is the data type transformation caused using a cast operator.

The **unary cast operator** is a more complete name for the cast operator that performs explicit conversions.

A **unary operator** uses only one operand.

The **standard input device** normally is the keyboard.

A **token** is a unit of data; the `Scanner` class separates input into tokens.

A **prompt** is a message that requests and describes user input.

**Echoing the input** means to repeat the user's entry as output so the user can visually confirm the entry's accuracy.

The **keyboard buffer** is a small area of memory where keystrokes are stored before they are retrieved into a program.

The **type-ahead buffer** is the keyboard buffer.

To **consume** an entry is to retrieve and discard it without using it.

An **input dialog box** asks a question and provides a text field in which the user can enter a response.

The **`showInputDialog()` method** creates an input dialog box.

**Type-wrapper classes**, contained in the `java.lang` package, include methods that can process primitive type values.

To **parse** means to break into component parts.

A **confirm dialog box** displays the options Yes, No, and Cancel; you can create one using the **`showConfirmDialog()` method** in the `JOptionPane` class.

## Chapter Summary

- Variables are named memory locations in which programs store values; the value of a variable can change. You must declare all variables you want to use in a program by providing a data type and a name. Java provides for eight primitive types of data: `boolean`, `byte`, `char`, `double`, `float`, `int`, `long`, and `short`. A named constant is a memory location that holds a value that can never be changed; it is preceded by the keyword `final`.
- A variable of type `int` can hold any whole number value from  $-2,147,483,648$  to  $+2,147,483,647$ . The types `byte`, `short`, and `long` are all variations of the integer type.

- A `boolean` type variable can hold a `true` or `false` value. Java supports six relational operators: `>`, `<`, `==`, `>=`, `<=`, and `!=`.
- A floating-point number contains decimal positions. Java supports two floating-point data types: `float` and `double`.
- You use the `char` data type to hold any single character. You type constant character values in single quotation marks. You type `String` constants that store more than one character between double quotation marks. You can store some characters using an escape sequence, which always begins with a backslash.
- You can display variable or constant values using `System.out.print()` and `println()` statements as well as by using dialog boxes. There are five standard arithmetic operators for integers: `+`, `-`, `*`, `/`, and `%`. Operator precedence is the order in which parts of a mathematical expression are evaluated. Multiplication, division, and remainder always take place prior to addition or subtraction in an expression. Right and left parentheses can be added within an expression when exceptions to this rule are required. When multiple pairs of parentheses are added, the innermost expression surrounded by parentheses is evaluated first.
- When you perform mathematical operations on unlike types, Java implicitly converts the variables to a unifying type. You can explicitly override the unifying type imposed by Java by performing a type cast.
- You can use the `Scanner` class and the `System.in` object to accept user input from the keyboard. Several methods are available to convert input to usable data, including `nextDouble()`, `nextInt()`, and `nextLine()`.
- You can accept input using the `JOptionPane` class. The `showInputDialog()` method returns a `String`, which must be converted to a number using a type-wrapper class before you can use it as a numeric value.

## Review Questions

1. When data cannot be changed after a class is compiled, the data is \_\_\_\_\_.
  - a. constant
  - b. variable
  - c. volatile
  - d. mutable
2. Which of the following is not a primitive data type in Java?
  - a. `boolean`
  - b. `byte`
  - c. `int`
  - d. `sector`
3. Which of the following elements is not required in a variable declaration?
  - a. a type
  - b. an identifier
  - c. an assigned value
  - d. a semicolon

4. The assignment operator in Java is \_\_\_\_\_.
  - a. =
  - b. ==
  - c. :=
  - d. ::
5. Assuming you have declared `shoeSize` to be a variable of type `int`, which of the following is a valid assignment statement in Java?
  - a. `shoeSize = 9;`
  - b. `shoeSize = 9.5;`
  - c. `shoeSize = '9';`
  - d. `shoeSize = "nine";`
6. Which of the following data types can store a value in the least amount of memory?
  - a. `short`
  - b. `long`
  - c. `int`
  - d. `byte`
7. A `boolean` variable can hold \_\_\_\_\_.
  - a. any character
  - b. any whole number
  - c. any decimal number
  - d. the value `true` or `false`
8. The value 137.68 can be held by a variable of type \_\_\_\_\_.
  - a. `int`
  - b. `float`
  - c. `double`
  - d. Two of the preceding answers are correct.
9. An escape sequence always begins with a(n) \_\_\_\_\_.
  - a. `e`
  - b. forward slash
  - c. backslash
  - d. equal sign
10. Which Java statement produces the following output?  
w  
xyz
  - a. `System.out.println("wxyz");`
  - b. `System.out.println("w" + "xyz");`
  - c. `System.out.println("w\nxyz");`
  - d. `System.out.println("w\nx\ny\nz");`
11. The remainder operator \_\_\_\_\_.
  - a. is represented by a forward slash
  - b. must follow a division operation
  - c. provides the quotient of integer division
  - d. is none of the above

12. According to the rules of operator precedence, when division occurs in the same arithmetic statement as \_\_\_\_\_, the division operation always takes place first.
- a. multiplication
  - b. remainder
  - c. subtraction
  - d. Answers a and b are correct.
13. The “equal to” relational operator is \_\_\_\_\_.
- a. =
  - b. ==
  - c. !=
  - d. !!
14. When you perform arithmetic with values of diverse types, Java \_\_\_\_\_.
- a. issues an error message
  - b. implicitly converts the values to a unifying type
  - c. requires you to explicitly convert the values to a unifying type
  - d. implicitly converts the values to the type of the first operand
15. If you attempt to add a `float`, an `int`, and a `byte`, the result will be a(n) \_\_\_\_\_.
- a. `float`
  - b. `int`
  - c. `byte`
  - d. error message
16. You use a \_\_\_\_\_ to explicitly override an implicit type.
- a. mistake
  - b. type cast
  - c. format
  - d. type set
17. In Java, what is the value of  $3 + 7 * 4 + 2$ ?
- a. 21
  - b. 33
  - c. 42
  - d. 48
18. Which assignment is correct in Java?
- a. `int value = (float) 4.5;`
  - b. `float value = 4 (double);`
  - c. `double value = 2.12;`
  - d. `char value = 5c;`
19. Which assignment is correct in Java?
- a. `double money = 12;`
  - b. `double money = 12.0;`
  - c. `double money = 12.0d;`
  - d. All of the above are correct.
20. Which assignment is correct in Java?
- a. `char aChar = 5.5;`
  - b. `char aChar = "W";`
  - c. `char aChar = '*';`
  - d. Two of the preceding answers are correct.

## Exercises

- What is the numeric value of each of the following expressions as evaluated by Java?
  - $4 + 6 * 3$
  - $6 / 3 * 7$
  - $18 / 2 + 14 / 2$
  - $16 / 2$
  - $17 / 2$
  - $28 / 5$
  - $16 \% 2$
  - $17 \% 2$
  - $28 \% 5$
  - $28 \% 5 * 3 + 1$
  - $(2 + 3) * 4$
  - $20 / (4 + 1)$
- What is the value of each of the following Boolean expressions?
  - $4 > 1$
  - $5 <= 18$
  - $43 >= 43$
  - $2 == 3$
  - $2 + 5 == 7$
  - $3 + 8 <= 10$
  - $3 != 9$
  - $13 != 13$
  - $-4 != 4$
  - $2 + 5 * 3 == 21$
- Choose the best data type for each of the following so that no memory storage is wasted. Give an example of a typical value that would be held by the variable, and explain why you chose the type you did.
  - your age
  - the U.S. national debt
  - your shoe size
  - your middle initial
- Write a Java class that declares variables to represent the length and width of a room in feet. Assign appropriate values to the variables—for example, `length = 15` and `width = 25`. Compute and display the floor space of the room in square feet (area = length \* width). Display explanatory text with the value—for example, `The floor space is 375 square feet`. Save the class as **Room.java**.
  - Convert the `Room` class to an interactive application. Instead of assigning values to the length and width variables, accept them from the user as input. As output, echo the user's entries as well as displaying the floor space. Save the revised class as **Room2.java**.
- Write a Java class that declares variables to represent the length and width of a room in feet and the price of carpeting per square foot in dollars and cents. Assign appropriate values to the variables. Compute and display, with explanatory text, the cost of carpeting the room. Save the class as **Carpet.java**.
  - Convert the `Carpet` class to an interactive application. Instead of assigning values to the length, width, and price variables, accept them from the user as input. Save the revised class as **Carpet2.java**.

6.
  - a. Write a class that declares a variable named `minutes`, which holds minutes worked on a job, and assign a value. Display the value in hours and minutes; for example, 197 minutes becomes 3 hours and 17 minutes. Be sure to use a named constant where appropriate. Save the class as **Time.java**.
  - b. Write an interactive version of the `Time` class that accepts the minutes worked from a user. Save the class as **Time2.java**.
7. Write a class that declares variables to hold your three initials. Display the three initials with a period following each one, as in J.M.F. Save the class as **Initials.java**.
8. Write a class that prompts a student for the number of credit hours in which the student is enrolled, and the amount of money spent on books. Display, with full explanation, the student's total fees. The total is \$85 per credit hour, plus the amount for books, plus a \$65 athletic fee. Save the class as **Fees.java**.
9. Write a class that accepts a user's hourly rate of pay and the number of hours worked. Display the user's gross pay, the withholding tax (15% of gross pay), and the net pay (gross pay – withholding). Save the class as **Payroll.java**.
10. Write a class that calculates and displays the conversion of an entered number of dollars into currency denominations—20s, 10s, 5s, and 1s. Save the class as **Dollars.java**.
11. Write a program that accepts a temperature in Fahrenheit from a user and converts it to Celsius by subtracting 32 from the Fahrenheit value and multiplying the result by 5/9. Display both values. Save the class as **FahrenheitToCelsius.java**.
12. Travel Tickets Company sells tickets for airlines, tours, and other travel-related services. Because ticket agents frequently mistype long ticket numbers, Travel Tickets has asked you to write an application that indicates invalid ticket number entries. The class prompts a ticket agent to enter a six-digit ticket number. Ticket numbers are designed so that if you drop the last digit of the number, then divide the number by 7, the remainder of the division will be identical to the last dropped digit. This process is illustrated in the following example:

- 
- |        |   |
|--------|---|
| Step 1 | Enter the ticket number; for example, 123454.   |
| Step 2 | Remove the last digit, leaving 12345.   |
| Step 3 | Determine the remainder when the ticket number is divided by 7. In this case, 12345 divided by 7 leaves a remainder of 4. |
| Step 4 | Assign the Boolean value of the comparison between the remainder and the digit dropped from the ticket number.            |
| Step 5 | Display the result— <code>true</code> or <code>false</code> —in a message box.  |
-

Accept the ticket number from the agent and verify whether it is a valid number. Test the application with the following ticket numbers:

- 123454; the comparison should evaluate to `true`
- 147103; the comparison should evaluate to `true`
- 154123; the comparison should evaluate to `false`

Save the program as **TicketNumber.java**.



## Debugging Exercise

- Each of the following files in the Chapter.02 folder of your downloadable student files has syntax and/or logic errors. In each case, determine the problem and fix the application. After you correct the errors, save each file using the same filename preceded with *Fix*. For example, `DebugTwo1.java` will become `FixDebugTwo1.java`.
  - `DebugTwo1.java`
  - `DebugTwo2.java`
  - `DebugTwo3.java`
  - `DebugTwo4.java`



When you change a filename, remember to change every instance of the class name within the file so that it matches the new filename. In Java, the filename and class name must always match.



## Game Zone

- Mad Libs*<sup>®</sup> is a children's game in which they provide a few words that are then incorporated into a silly story. The game helps children understand different parts of speech because they are asked to provide specific types of words. For example, you might ask a child for a noun, another noun, an adjective, and a past-tense verb. The child might reply with such answers as *table*, *book*, *silly*, and *studied*. The newly created Mad Lib might be:

Mary had a little *table*

Its *book* was *silly* as snow

And everywhere that Mary *studied*

The *table* was sure to go.

Create a Mad Lib program that asks the user to provide at least four or five words, and then create and display a short story or nursery rhyme that uses them. Save the file as **MadLib.java**.



# Using Methods, Classes, and Objects

In this chapter, you will:

- ⦿ Create methods
- ⦿ Add parameters to methods
- ⦿ Create methods that return values
- ⦿ Study class concepts
- ⦿ Create a class
- ⦿ Create instance methods in a class
- ⦿ Declare objects and use their methods
- ⦿ Organize classes
- ⦿ Create constructors
- ⦿ Appreciate classes as data types

## Creating Methods

A **method** is a program module that contains a series of statements that carry out a task. You have already seen Java classes that contain a `main()` method. The `main()` method can execute additional methods. To execute a method, you **invoke** or **call** it. In other words, a **calling method** makes a **method call**, which invokes a **called method**. The calling method is also known as a **client method**; a called method provides a service for its client. Any class can contain an unlimited number of methods, and each method can be called an unlimited number of times.



Devices you own might contain features you never use. For example, you might use a DVR to play movies, but never to record TV programs, or you might never use the defrost option on your microwave oven. Similarly, a class might contain methods that are never called from a particular application.

Consider the simple `First` class that you saw in Chapter 1, shown in Figure 3-1. Suppose you want to add three lines of output to this application to display your company's name and address. You can simply add three new `println()` statements, but instead you might choose to create a separate method to display the three new lines.

```
public class First
{
    public static void main(String[] args)
    {
        System.out.println("First Java application");
    }
}
```

**Figure 3-1** The `First` class



Although there are differences, if you have used other programming languages, you can think of methods as being similar to procedures, functions, or subroutines.

There are two major reasons to create a separate method to display the three address lines. First, the `main()` method remains short and easy to follow because `main()` contains just one statement to call the method, rather than three separate `println()` statements to perform the work of the method. What is more important is that a method is easily reusable. After you create the name and address method, you can use it in any application that needs the company's name and address. In other words, you do the work once, and then you can use the method many times.

A method must include the following:

- A **method header**—A method's header provides information about how other methods can interact with it. A method header is also called a **declaration**.
- A **method body** between a pair of curly braces—The method body contains the statements that carry out the work of the method. A method's body is called its

**implementation.** Technically, a method is not required to contain any statements in its body, but you usually would have no reason to create an empty method in a class. Sometimes, while developing a program, the programmer creates an empty method as a placeholder, and fills in the implementation later. An empty method is called a **stub**.



Using a method name to contain or encapsulate a series of statements is an example of the feature that programmers call **abstraction**. Consider abstract art, in which the artist tries to capture the essence of an object without focusing on the details. Similarly, when programmers employ abstraction, they use a general method name in a module rather than list all the detailed activities that will be carried out by the method.

The method header is the first line of a method. It contains the following:

- An optional access specifier—The access specifier for a Java method can be any of the following modifiers: `public`, `private`, `protected`, or, if left unspecified, `package`. Most often, methods are given `public` access. Endowing a method with `public` access means any class can use it. In addition, like `main()`, any method that can be used without instantiating an object requires the keyword modifier `static`.
- The **return type** for the method—A method might **return a value**, or send it back, to its calling method. If so, the method's return type is the data type of the returned data. A method that returns no data has a return type of `void`.
- The method name—The name can be any legal identifier. That is, it must be one word with no embedded spaces, and cannot be a Java keyword.
- A set of parentheses—The parentheses optionally might contain data to be sent to the method. For example, when you write a `main()` method in a class, the parentheses in its header surround (`String[] args`).



You first learned the term *access specifier* in Chapter 1. Access specifiers are sometimes called **access modifiers**.



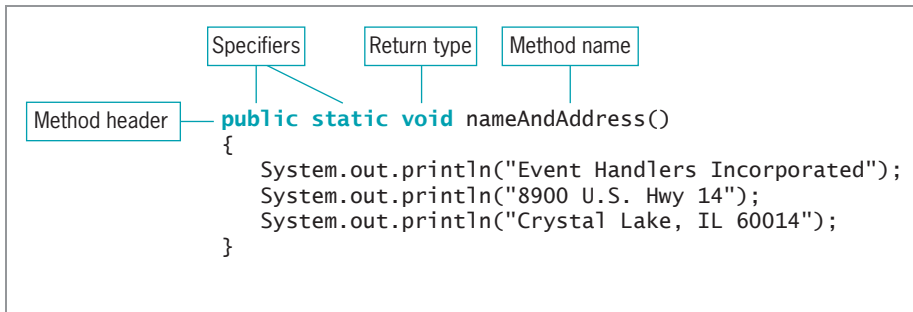
Besides the access specifiers `public`, `private`, and `protected`, Java uses additional specifiers that define how a method can be used. You will learn more about these terms, and about packages, later in this book.



Classes can contain instance methods and class methods. Instance methods operate on an object, and do not use the `static` keyword. Class methods do not need an object instance in order to be used, and they use the `static` keyword. You will learn more about static and nonstatic methods later in this chapter.

You can write the `nameAndAddress()` method shown in Figure 3-2. According to its declaration, the method is `public` and `static`, meaning any class can use it and no objects need to be created. Like the `main()` method you have been using in your Java applications, the `nameAndAddress()` method returns nothing, so its return type is `void`. (You will learn more about return types later in this chapter.) The method receives nothing, so its parentheses are empty. (You will learn more

about methods whose parentheses are not empty in the next section.) The method body, consisting of three `println()` statements, appears between curly braces.



**Figure 3-2** The `nameAndAddress()` method

You place a method within a class, but it must be outside of any other methods. In other words, you cannot place a method within another method. Figure 3-3 shows the two locations where you can place additional methods within the `First` class—within the curly braces of the class, but outside of (either before or after) any other methods. Methods can never overlap. That is, no method can be placed within another method, and no method can start before another method has ended. The order in which you place methods' bodies in a class has no bearing on the order in which the methods are called. Any method in a file might call any of the other methods in any order and any number of times. The order in which you call methods is what makes a difference in how an application executes.

```
public class First
{
    // You can place additional methods here, before main()
    public static void main(String[] args)
    {
        System.out.println("First Java application");
    }
    // You can place additional methods here, after main()
}
```

**Figure 3-3** Placement of methods within a class



The `main()` method executes first in an application, no matter where you physically place the `main()` method within its class. Remember that every Java application must contain a `main()` method, but each Java class is not required to contain one.

If you want the `main()` method in the `First` class to call the `nameAndAddress()` method, you simply use the `nameAndAddress()` method's name as a statement within the body of `main()`. Figure 3-4 shows a complete working application. In this application, `main()` performs two actions. First, it calls the `nameAndAddress()` method, and then it displays "First Java application".

```

public class First
{
    public static void main(String[] args)
    {
        nameAndAddress();
        System.out.println("First Java application");
    }
    public static void nameAndAddress()
    {
        System.out.println("Event Handlers Incorporated");
        System.out.println("8900 U.S. Hwy 14");
        System.out.println("Crystal Lake, IL 60014");
    }
}

```

**Figure 3-4** First class with `main()` calling `nameAndAddress()`

Figure 3-5 shows the output from the execution of the `First` class. Because the `main()` method calls the `nameAndAddress()` method before it displays the phrase “First Java application”, the name and address appear first in the output.



Watch the video *Methods*.

```

C:\Java>java First
Event Handlers Incorporated
8900 U.S. Hwy 14
Crystal Lake, IL 60014
First Java application
C:\Java>_

```

**Figure 3-5** Output of the `First` application, including the `nameAndAddress()` method

The full name of the `nameAndAddress()` method is `First.nameAndAddress()`; which includes the class name, a dot, and the method name. (The name does not include an object because `nameAndAddress()` is a static method.) A complete name that includes the class is a **fully qualified identifier**. When you use the `nameAndAddress()` method within its own class, you do not need to use the fully qualified name (although you can); the simple method name alone is enough. However, if you want to use the `nameAndAddress()` method in another class, the compiler does not recognize the method unless you use the full name. You have used similar syntax (including a class name, dot, and method name) when calling the `JOptionPane.showMessageDialog()` method.

Each of two different classes can have its own method named `nameAndAddress()`. Such a method in the second class would be entirely distinct from the identically named method in the first class. You could use both methods in a third class by using their fully qualified identifiers. Two classes in an application cannot have the same name.



Think of the class name as the family name. Within your own family, you might refer to an activity as “the family reunion,” but outside the family people need to use a surname as well, as in “the Anderson family reunion.” Similarly, within a class a method name alone is sufficient, but outside the class you need to use the fully qualified name.

## TWO TRUTHS & A LIE

### Creating Methods

1. Any class can contain an unlimited number of methods, and each method can be called an unlimited number of times.
2. A method declaration contains an optional access specifier, the return type, a name, and a set of parentheses.
3. A method is usually written within another method.

The false statement is #3. A method is written within a class, but not within any other methods.

## Adding Parameters to Methods

Some methods require that data be sent to them when they are called. Data items you use in a call to a method are called **arguments**. When the method receives the data items, they are called **parameters**. Methods that receive data are flexible because they can produce different results depending on what data they receive.

As a real-life example, when you make a restaurant reservation, you do not need to employ a different method for every date of the year at every possible time of day. Rather, you can supply the date and time as information to the person who carries out the method. The method, recording the reservation, is then carried out in the same manner, no matter what date and time are supplied. In a program, if you design a method to square numeric values, it makes sense to design a `square()` method that you can supply with an argument that represents the value to be squared, rather than having to develop a `square1()` method (that squares the value 1), a `square2()` method (that squares the value 2), and so on. To call a `square()` method that takes an argument, you might write a statement like `square(17);` or `square(86);`.



Any time it is called, the `println()` method can receive any one of an infinite number of arguments—“Hello”, “Goodbye”, or any other `String`. No matter what message is sent to `println()`, the message displays correctly. If the `println()` method could not accept arguments, it would not be practical to use it within applications.

An important principle of object-oriented programming is the notion of **implementation hiding**, the encapsulation of method details within a class. That is, when a client calls a method, it doesn't need to know the details of how the method is executed. For example, when you make a real-life restaurant reservation, you do not need to know how the reservation is actually recorded at the restaurant—perhaps it is written in a book, marked on a large chalkboard, or entered into a computerized database. The implementation details don't concern you as a client, and if the restaurant changes its

methods from one year to the next, the change does not affect your use of the reservation method—you still call and provide your name, a date, and a time. With well-written object-oriented programming methods, using implementation hiding means that a method that calls another must know the name of the called method and what type of information to send. (Usually, you also want to know about any data returned by the method; you will learn about returned data later in this chapter.) However, the client does not need to know how the method works internally. In other words, the calling method needs to understand only the **interface** to the called method. The interface is the only part of a method that the method's client sees or with which it interacts. In addition, if you substitute a new or revised method implementation, as long as the interface to the method does not change, you won't need to make any changes in any methods that call the altered method.



Hidden implementation methods are often referred to as existing in a **black box**. Many everyday devices are black boxes—that is, you can use them without understanding how they work. For example, most of us use telephones, television sets, and automobiles without understanding much about their internal mechanisms.



As an example of how professional programmers use implementation hiding, you can visit the Java Web site at <http://java.sun.com> to see the interfaces for thousands of prewritten methods that reside in the Java prewritten classes. You are not allowed to see the code inside these methods; you see only their interfaces, which is all you need to be able to use them.

When you write the method declaration for a method that can receive a parameter, you begin by defining the same elements as you do for methods that do not accept parameters—optional access specifiers, the return type for the method, and the method name. In addition, you must include the following items within the method declaration parentheses:

- The parameter type
- A local name for the parameter

For example, the declaration for a public method named `predictRaise()` that displays a person's salary plus a 10% raise could be written as follows:

```
public static void predictRaise(double moneyAmount)
```

You can think of the parentheses in a method declaration as a funnel into the method—parameters listed there contain data that is “dropped into” the method. A parameter accepted by a method can be any data type, including the primitive types, such as `int`, `double`, `char`, and so on; it also can be a class type.

The parameter `double moneyAmount` within the parentheses indicates that the `predictRaise()` method will receive a value of type `double`, and that within the method, the passed value will be known as `moneyAmount`. Figure 3-6 shows a complete method.

```
public static void predictRaise(double moneyAmount)
{
    double newAmount;
    final double RAISE = 1.10;
    newAmount = moneyAmount * RAISE;
    System.out.println("With raise, salary is " + newAmount);
}
```

Parameter type

Parameter identifier that is local to the method

**Figure 3-6** The `predictRaise()` method

The `predictRaise()` method is a `void` method because it does not need to return any value to any other method that uses it—its only function is to receive the `moneyAmount` value, multiply it by the `RAISE` constant (1.10, which results in a 10% salary increase), and then display the result. The phrases *void method* and *method of type void* both refer to a method that has a `void` return type.

You can call the `predictRaise()` method by using either a constant value or a variable as an argument. Thus, both `predictRaise(472.25);` and `predictRaise(mySalary);` invoke the `predictRaise()` method correctly, assuming that `mySalary` is declared as a `double` variable and is assigned an appropriate value in the calling method. You can call the `predictRaise()` method any number of times, with a different constant or variable argument each time. Each of these arguments becomes known as `moneyAmount` within the method. The identifier `moneyAmount` represents a variable that holds any `double` value passed into the `predictRaise()` method; `moneyAmount` holds a copy of the value passed to it.

It is interesting to note that if the value used as an argument in the method call to `predictRaise()` is a variable, it might possess the same identifier as `moneyAmount` or a different one, such as `mySalary`. For example, the code in Figure 3-7 shows three calls to the `predictRaise()` method, and Figure 3-8 shows the output. One call uses a constant, 400.00. The other two use variables—one with the same name as `moneyAmount` and the other with a different name, `mySalary`. The identifier `moneyAmount` is simply a placeholder while it is being used within the `predictRaise()` method, no matter what name it “goes by” in the calling method. The parameter `moneyAmount` is a **local variable** to the `predictRaise()` method; that is, it is known only within the boundaries of the method. The variable and constant declared within the method are also local to the method.



```

public class DemoRaise
{
    public static void main(String[] args)
    {
        double mySalary = 200.00;
        double moneyAmount = 800.00;
        System.out.println("Demonstrating some raises");
        predictRaise(400.00);
        predictRaise(mySalary);
        predictRaise(moneyAmount);
    }

    public static void predictRaise(double moneyAmount)
    {
        double newAmount;
        final double RAISE = 1.10;
        newAmount = moneyAmount * RAISE;
        System.out.println("With raise, salary is " + newAmount);
    }
}

```

**Figure 3-7** The DemoRaise class with a main() method that uses the predictRaise() method three times



Recall that the `final` modifier makes `RAISE` constant. Because `moneyAmount` is not altered within the `predictRaise()` method in Figure 3-7, you could also make it constant by declaring the method header as `public static void predictRaise(final double moneyAmount)`. There would be no difference in the program's execution, but declaring a parameter as `final` means it cannot be altered within the method. Someone reading your program would be able to see that the parameter is not intended to change.

```

C:\Java>java DemoRaise
Demonstrating some raises
With raise, salary is 440.000000000000006
With raise, salary is 220.000000000000003
With raise, salary is 880.00000000000001
C:\Java>

```

**Figure 3-8** Output of the DemoRaise application



Notice the imprecise output in Figure 3-8. As you learned in Chapter 2, floating-point arithmetic can be imprecise. If you do not like the appearance of the numbers in this output, you can use the techniques described in Appendix C to format your output to a specific number of decimal places.

Each time the `predictRaise()` method in Figure 3-7 executes, a `moneyAmount` variable is redeclared—that is, a new memory location large enough to hold a `double` is set up and named `moneyAmount`. Within the `predictRaise()` method, `moneyAmount` holds a copy of whatever value is passed into the method by the `main()` method. When the `predictRaise()` method ends, at the closing curly brace, the local `moneyAmount` variable ceases to exist. That is, if you change the value of `moneyAmount` after you have used it in the calculation within `predictRaise()`, it affects nothing else. The memory location that holds `moneyAmount` is released at the end of the method, and any changes to its value within the method do not affect any value in the calling method. In particular, don't think there would be any change in the variable named `moneyAmount` in the `main()` method; that variable, even though it has the same name as the locally declared parameter in the method, is a different variable with its own memory address, and is totally different from the one in the `predictRaise()` method. When a variable ceases to exist at the end of a method, programmers say the variable “goes out of scope.” A variable's scope is the part of a program in which a variable exists and can be accessed using its unqualified name. The next chapter discusses scope in greater detail.



If you pass a named constant to a method and the accepting parameter is not declared as `final`, then the parameter within the method is not constant. Conversely, if you pass a variable to a method that declares the accepting parameter to be `final`, then the value in the method is a constant.

## Creating Methods That Require Multiple Parameters

A method can require more than one parameter. You can pass multiple arguments to a method by listing the arguments within the call to the method and separating them with commas. For example, rather than creating a `predictRaise()` method that adds a 10% raise to every person's salary, you might prefer to create a method to which you can pass two values—the salary to be raised as well as a percentage figure by which to raise it. Figure 3-9 shows a method that uses two such parameters.

```
public static void predictRaiseUsingRate(double money, double rate)
{
    double newAmount;
    newAmount = money * (1 + rate);
    System.out.println("With raise, new salary is " + newAmount);
}
```

**Figure 3-9** The `predictRaiseUsingRate()` method that accepts two parameters

In Figure 3-9, two parameters (`double money` and `double rate`) appear within the parentheses in the method header. A comma separates each parameter, and each parameter requires its own declared type (in this case, both are `double`) as well as its own identifier. Note that a declaration for a method that receives two or more parameters must list the type for each parameter separately, even if the parameters have the same type.

When values are passed to the method in a statement such as the following, the first value passed is referenced as `money` within the method, and the second value passed is referenced as `rate`:

```
predictRaiseUsingRate(mySalary, promisedRate);
```

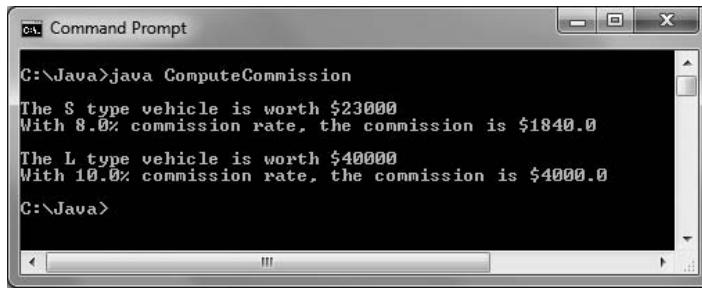
Therefore, arguments passed to the method must be passed in the correct order. The call `predictRaiseUsingRate(200.00, 0.10)`; results in output representing a 10% raise based on a \$200.00 salary amount (or \$220.00), but `predictRaiseUsingRate(0.10, 200.00)`; results in output representing a 20,000% raise based on a salary of 10 cents (or \$20.10). If two method parameters are the same type—for example, two `double`s—passing arguments to a method in the wrong order results in a logical error; that is, the program does compile and execute, but it probably produces incorrect results. If a method expects parameters of diverse types, passing arguments in the wrong order constitutes a syntax error, and the program does not compile.

You can write a method so that it takes any number of parameters in any order. However, when you call a method, the arguments you send to a method must match in order—both in number and in type—the parameters listed in the method declaration. A method's **signature** is the combination of the method name and the number, types, and order of arguments. A method call must match the called method's signature.

Thus, a method to compute an automobile salesperson's commission amount might require arguments such as an integer dollar value of a car sold, a `double` percentage commission rate, and a character code for the vehicle type. The correct method executes only when three arguments of the correct types are sent in the correct order. Figure 3-10 shows a class containing a three-parameter method and a `main()` method that calls it twice, once using variable arguments and again using constant arguments. Figure 3-11 shows the output of the application.

```
public class ComputeCommission
{
    public static void main(String[] args)
    {
        char vType = 'S';
        int value = 23000;
        double commRate = 0.08;
        computeCommission(value, commRate, vType);
        computeCommission(40000, 0.10, 'L');
    }
    public static void computeCommission(int value,
        double rate, char vehicle)
    {
        double commission;
        commission = value * rate;
        System.out.println("\nThe " + vehicle +
            " type vehicle is worth $" + value);
        System.out.println("With " + (rate * 100) +
            "% commission rate, the commission is $" +
            commission);
    }
}
```

**Figure 3-10** The `ComputeCommission` class



```

C:\Java>java ComputeCommission
The S type vehicle is worth $23000
With 8.0% commission rate, the commission is $1840.0

The L type vehicle is worth $40000
With 10.0% commission rate, the commission is $4000.0
C:\Java>

```

**Figure 3-11** Output of the ComputeCommission application



The arguments in a method call are often referred to as **actual parameters**. The variables in the method declaration that accept the values from the actual parameters are **formal parameters**.



When you look at Java applications, you might see methods that appear to be callable in multiple ways. For example, you can use `System.out.println()` with no arguments to display a blank line, or with a `String` argument to display the `String`. You can use the method with different argument lists only because multiple versions of the method have been written, each taking a specific set of arguments. The ability to execute different method implementations by altering the argument used with the method name is known as *method overloading*, a concept you will learn about in the next chapter.

## TWO TRUTHS & A LIE

### Adding Parameters to Methods

1. Any class can contain an unlimited number of methods, and each method can be called an unlimited number of times.
2. Arguments are used in method calls; they are passed to parameters in method headers.
3. A method header always contains a return type, an identifier, and a parameter list within parentheses.

The false statement is #3. A method header always contains a return type, an identifier, and parentheses, but the parameter list might be empty.

## Creating Methods That Return Values

A method ends when any of the following events takes place:

- The method completes all of its statements. You have seen methods like this in the last section.

- The method throws an exception. Exceptions are errors; you will learn about them in the chapter *Exception Handling*.
- The method reaches a **return** statement. A **return statement** causes a method to end and the program's logic to return to the calling method. Also, a **return** statement frequently sends a value back to the calling method.

The return type for a method can be any type used in Java, which includes the primitive types `int`, `double`, `char`, and so on, as well as class types (including class types you create). Of course, a method can also return nothing, in which case the return type is `void`.

A method's return type is known more succinctly as a **method's type**. For example, the declaration for the `nameAndAddress()` method shown earlier in Figure 3-4 is written as follows:

```
public static void nameAndAddress()
```

This method is `public`, and it returns no value, so it is type `void`. A method that returns `true` or `false`, depending on whether an employee worked overtime hours, might be declared as:

```
public boolean workedOvertime()
```

This method returns a Boolean value, so it is type `boolean`.



In addition to returning one of the primitive types, a method can return a class type. If your application contains a class named `BankLoan`, a method might return an instance of a `BankLoan`, as in `public BankLoan approvalProcess()`. In other words, a method can return anything from a simple `int` to a complicated `BankLoan` that is composed of 20 data fields. You will learn more about class types later in this chapter.

The `predictRaise()` method shown earlier produces output, but does not return any value, so its return type is `void`. If you want to create a method to return the new, calculated salary value rather than display it, the header would be written as follows:

```
public static double predictRaise(double moneyAmount)
```

Figure 3-12 shows this method.

```
public static double predictRaise(double moneyAmount)
{
    double newAmount;
    final double RAISE = 1.10;
    newAmount = moneyAmount * RAISE;
    return newAmount;
}
```

**Figure 3-12** The `predictRaise()` method returning a `double`

Notice the shaded return type `double` that precedes the method name in the `predictRaise()` method header in Figure 3-12. Also notice the shaded return statement that is the last statement within the method. The **return** statement causes a value to be sent from a called method back to the calling method. In this case, the value stored in `newAmount` is sent back to

any method that calls the `predictRaise()` method. A method's declared return type must match the type of the value used in the `return` statement; if it does not, the class does not compile. A method can return, at most, one value. The value can be a primitive data type, such as `int`, `char`, or `double`, or it can be a class type.

116



All methods except `void` methods require a `return` statement that returns a value of the appropriate type. You can place a `return` statement in a `void` method that is simply the word `return` followed by a semicolon. However, most Java programmers do not include a `return` statement in a method when nothing is returned.

You cannot place any statements after a method's `return` statement. Such statements are **unreachable statements** because the logical flow leaves the method at the `return` statement. An unreachable statement can never execute, and it causes a compiler error. Unreachable statements are also called **dead code**.



A method can contain multiple `return` clauses if they are embedded in a decision, although this practice is not recommended because it can lead to errors that are difficult to detect. However, no other statements can be placed after the last `return` clause in a method. You will learn about decision making in the chapter *Making Decisions*.

If a method returns a value, then when you call the method, you normally use the returned value, although you are not required to do so. For example, when you invoke the `predictRaise()` method, you might want to assign the returned value (also called the method's value) to a `double` variable named `myNewSalary`, as in the following statement:

```
myNewSalary = predictRaise(mySalary);
```

The `predictRaise()` method returns a `double`, so it is appropriate to assign the method's returned value to a `double` variable.

Alternatively, you can choose to use a method's returned value directly, without storing it in any variable. When you use a method's value, you use it in the same way you would use any variable of the same type. For example, you can display a return value in a statement such as the following:

```
System.out.println("New salary is " + calculateRaise(mySalary));
```

In the preceding statement, the call to the `calculateRaise()` method is made from within the `println()` method call. Because `calculateRaise()` returns a `double`, you can use the method call `calculateRaise()` in the same way that you would use any simple `double` value. As another example, you can perform arithmetic with a method's return value, as in the following statement:

```
double spendingMoney = calculateRaise(mySalary) - expenses;
```

## Chaining Method Calls

Any method might call any number of other methods. For example, a `main()` method might call a `predictRaise()` method, and the `predictRaise()` method might call a `calculateBonus()` method, as shown in the shaded statement in Figure 3-13.

```
public static double predictRaise(double moneyAmount)
{
    double newAmount;
    double bonusAmount;
    final double RAISE = 1.10;
    newAmount = moneyAmount * RAISE;
    bonusAmount = calculateBonus(newAmount);
    newAmount = newAmount + bonusAmount;
    return newAmount;
}
```

**Figure 3-13** The `predictRaise()` method calling the `calculateBonus()` method

Looking at the call to the `calculateBonus()` method from the `predictRaise()` method, you do not know how `calculateBonus()` works. You only know that the `calculateBonus()` method accepts a `double` as a parameter (because `newAmount` is passed into it) and that it must return either a `double` or a type that can automatically be promoted to a `double` (because the result is stored in `bonusAmount`). In other words, the method acts as a black box. As an example, the `calculateBonus()` method might look like the version shown in Figure 3-14 that adds a \$50.00 bonus to a salary parameter.

```
public static double calculateBonus(double salary)
{
    final double BONUS_AMT = 50.00;
    salary = salary + BONUS_AMT;
    return salary;
}
```

**Figure 3-14** The `calculateBonus()` method



Watch the video *Methods and Parameters*.

## TWO TRUTHS & A LIE

### Creating Methods That Return Values

1. The return type for a method can be any type used in Java, including `int`, `double`, and `void`.
2. A method's declared return type must match the type of the value used in the parameter list.
3. You cannot place a method within another method, but you can call a method from within another method.

The false statement is #2. A method's declared return type must match the type of the value used in the return statement.

## Learning About Class Concepts

When you think in an object-oriented manner, everything is an object, and every object is a member of a class. You can think of any inanimate physical item as an object—your desk, your computer, and the building in which you live are all called objects in everyday conversation. You can also think of living things as objects—your houseplant, your pet fish, and your sister are objects. Events are also objects—the stock purchase you made, the mortgage closing you attended, and a graduation party that was held in your honor are all objects.

Everything is an object, and every object is a member of a more general class. Your desk is a member of the class that includes all desks, and your pet fish is a member of the class that contains all fish. An object-oriented programmer would say that your desk is an instance of the `Desk` class and your fish is an instance of the `Fish` class. These statements represent **is-a relationships**—that is, relationships in which the object “is a” concrete example of the class. Expressing an is-a relationship is correct only when you refer to the object and the class in the proper order. You can say, “My oak desk with the scratch on top *is a* `Desk`,” and my goldfish named Moby *is a* `Fish`.” You don’t define a `Desk` by saying, “A `Desk` *is an* oak desk with a scratch on top,” or explain what a `Fish` is by saying, “A `Fish` *is a* goldfish named Moby,” because both a `Desk` and a `Fish` are much more general. The difference between a class and an object parallels the difference between abstract and concrete. An object is an **instantiation** of a class, or one tangible example of a class. Your goldfish, my guppy, and the zoo’s shark each constitute one instantiation of the `Fish` class.



Programmers also use the phrase “is-a” when talking about inheritance relationships. You will learn more about inheritance in the chapters *Introduction to Inheritance* and *Advanced Inheritance Concepts*.

The concept of a class is useful because of its reusability. Objects gain their attributes from their classes, and all objects have predictable attributes because they are members of certain



classes. For example, if you are invited to a graduation party, you automatically know many things about the object (the party). You assume there will be a starting time, a certain number of guests, and some quantity of food. You understand what a party entails because of your previous knowledge of the `Party` class of which all parties are members. You don't know the number of guests or what food will be served at this particular party, but you understand that because all parties have guests and refreshments, this one must too. Because you understand the general characteristics of a `Party`, you anticipate different behaviors than if you plan to attend a `TheaterPerformance` object or a `DentalAppointment` object.



The data components of a class are often referred to as the **instance variables** of that class. Also, class data attributes are often called **fields** to help distinguish them from other variables you might use.

In addition to their attributes, objects have methods associated with them, and every object that is an instance of a class is assumed to possess the same methods. For example, for all `Party` objects, at some point you must set the date and time. In a program, you might name these methods `setDate()` and `setTime()`. Party guests need to know the date and time and might use methods named `getDate()` and `getTime()` to find out the date and time of any `Party` object. Method names that begin with *get* and *set* are very typical. You will learn more about get and set methods in the next section.

Your graduation party, then, might have the identifier `myGraduationParty`. As a member of the `Party` class, `myGraduationParty`, like all `Party` objects, might have data methods `setDate()` and `setTime()`. When you use them, the `setDate()` and `setTime()` methods require arguments, or information passed to them. For example, statements such as `myGraduationParty.setDate("May 12")` and `myGraduationParty.setTime("6 P.M.")` invoke methods that are available for the `myGraduationParty` object. When you use an object and its methods, think of being able to send a message to the object to direct it to accomplish some task—you can tell the `Party` object named `myGraduationParty` to set the date and time you request. Even though `yourAnniversaryParty` is also a member of the `Party` class, and even though it also has access to `setDate()` and `setTime()` methods, the arguments you send to `yourAnniversaryParty` methods will be different from those you send to `myGraduationParty` methods. Within any object-oriented program, you are continuously making requests to objects' methods and often including arguments as part of those requests.

In addition, some methods used in an application must return a message or value. If one of your party guests uses the `getDate()` method, the guest hopes that the method will respond with the desired information. Similarly, within object-oriented programs, methods are often called upon to return a piece of information to the source of the request. For example, a method within a `Payroll` class that calculates federal withholding tax might return a tax amount in dollars and cents, and a method within an `Inventory` class might return `true` or `false`, depending on the method's determination of whether an item is at the reorder point.

With object-oriented programming, sometimes you create classes so that you can instantiate objects from them, and other times you create classes to run as applications. Application classes frequently instantiate objects that use the objects of other classes (and their data and

methods). Sometimes you write classes that do both. The same programmer does not need to write every class he or she uses. Often, you will write programs that use classes created by others; similarly, you might create a class that others will use to instantiate objects within their own applications. You can call an application or class that instantiates objects of another prewritten class a **class client** or **class user**.



The `System` class that you have used to produce output in the Command Prompt window provides an example of using a class that was written by someone else. You did not have to create it or its `println()` method; both were created for you by Java's creators.



You can identify a class that is an application because it contains a `public static void main()` method. The `main()` method is the starting point for any application. You will write and use many classes that do not contain a `main()` method—these classes can be used by other classes that are applications or applets. (You will learn about applets in the chapter *Applets, Images, and Sound*.)



A Java application can contain only one method with the header `public static void main (String[] args)`. If you write a class that imports another class, and both classes have a `public main()` method, your application will not compile.

So far, you've learned that object-oriented programming involves objects that send messages to other objects requesting they perform tasks, and that every object belongs to a class. Understanding classes and how objects are instantiated from them is the heart of object-oriented thinking.

## TWO TRUTHS & A LIE

### Learning About Class Concepts

1. A class is an instantiation of many objects.
2. Objects gain their attributes and methods from their classes.
3. An application or class that instantiates objects of another prewritten class is a class client.

The false statement is #1. An object is one instantiation of a class.

## Creating a Class

When you create a class, you must assign a name to the class, and you must determine what data and methods will be part of the class. Suppose you decide to create a class named `Employee`. One instance variable of `Employee` might be an employee number, and two necessary methods might be a method to set (or provide a value for) the employee number and another method to get (or retrieve) that employee number. To begin, you create a class header with three parts:

- An optional access specifier
- The keyword `class`
- Any legal identifier you choose for the name of your class

For example, a header for a class that represents an employee might be:

```
public class Employee
```

The keyword `public` is a class modifier. Classes that are `public` are accessible by all objects, which means that public classes can be **extended**, or used as a basis for any other class. The most liberal form of access is `public`. Making access `public` means that if you develop a good `Employee` class, and someday you want to develop two classes that are more specific, `SalariedEmployee` and `HourlyEmployee`, then you do not have to start from scratch. Each new class can become an extension of the original `Employee` class, inheriting its data and methods.

121



You will learn about extended classes in the chapter *Introduction to Inheritance*.



You can use the following specifiers when defining a class: `public`, `final`, `abstract`, or `strictfp`. You will use the `public` specifier for most of your classes. You use the other specifiers only under special circumstances.

After writing the class header `public class Employee`, you write the body of the `Employee` class between a set of curly braces. The body contains the data fields and methods for the class. Figure 3-15 shows an `Employee` class that contains one data field named `empNum`. Data fields are variables you declare within a class but outside of any method.

```
public class Employee
{
    private int empNum;
}
```

**Figure 3-15** The `Employee` class with one field

In Figure 3-15, the data field `empNum` is not preceded by the keyword `static`. This means that when you eventually create, or instantiate, objects from the class, each object will have its own copy of the data field. In other words, because `empNum` is not `static`, each `Employee` object created from the class will have its own employee number.



To help you determine whether a data field should be `static` or not, you can ask yourself how many times it occurs. If it occurs once per class, it is `static`, but if it occurs once per object, it is not `static`.

You have already learned that Java supports four distinct access levels for member variables and methods: `private`, `protected`, `public`, and, if left unspecified, `package`. Most fields, like `empNum` in the `Employee` class, are `private`, which provides the highest level of security. Assigning **private access** to a field means that no other classes can access the field's values, and only methods of the same class are allowed to set, get, or otherwise use private variables. The principle used in creating private access is sometimes called **information hiding** and is an important component of object-oriented programs. A class's private data can be changed or manipulated only by a class's own methods and not by methods that belong to other classes. In contrast to fields, most class methods are `public`, not `private`. The resulting private data/public method arrangement provides a means for you to control outside access to your data—only a class's nonprivate methods can be used to access a class's private data. The situation is similar to hiring a public receptionist to sit in front of your private office and control which messages you receive (perhaps deflecting trivial or hostile ones) and which messages you send (perhaps checking your spelling, grammar, and any legal implications). The way in which the nonprivate methods are written controls how you use the private data.



The first release of Java (1.0) supported five access levels—the four listed previously plus `private protected`. The `private protected` access level is not supported in versions of Java higher than 1.0; you should not use it in your Java programs.



Data fields are most often `private` and not `static`. Only rarely is a data field made `public`. A class's fields are made `static` only when you do not want each object to have its own copy of the field. You will learn more about how and why to create `static` and nonstatic class members in the next section.



Data fields are most frequently made `public` when they are both `static` and `final`—that is, when a class contains a nonchanging value that you want to use without being required to create an object. For example, the Java `Math` class contains a `public` field called `PI` that you can use without instantiating a `Math` object. You will learn about the `Math` class in the next chapter.

## TWO TRUTHS & A LIE

### Creating a Class

1. A class header contains an optional access specifier, the keyword `class`, and an identifier.
2. When you instantiate objects, each has its own copy of each `static` data field in the class.
3. Most fields in a class are `private`, and most methods are `public`.

The false statement is #2. When you instantiate objects, each has its own copy of each nonstatic data field in the class.

## Creating Instance Methods in a Class

Besides data, classes contain methods. For example, one method you need for an `Employee` class that contains an `empNum` is the method to retrieve (or return) any `Employee`'s `empNum` for use by another class. A reasonable name for this method is `getEmpNum()`, and its declaration is `public int getEmpNum()` because it will have `public` access, return an integer (the employee number), and possess the identifier `getEmpNum()`. In Java, methods that get values from an object most frequently start with *get*. Using this three-letter prefix with your method names is not required, but it is conventional.

Figure 3-16 shows the complete `getEmpNum()` method.

```
public int getEmpNum()
{
    return empNum;
}
```

**Figure 3-16** The `getEmpNum()` method

The `getEmpNum()` method contains just one statement: the statement that accesses the value of the private `empNum` field.

Notice that, unlike the class methods you created earlier in this chapter, the `getEmpNum()` method does not employ the `static` modifier. The keyword `static` is used for classwide methods, but not for methods that “belong” to objects. If you are creating a program with a `main()` method that you will execute to perform some task, many of your methods will be `static` so you can call them from within `main()` without creating objects. However, if you are creating a class from which objects will be instantiated, most methods will probably be `nonstatic` because you will associate the methods with individual objects. For example, the `getEmpNum()` method must be `nonstatic` because it returns a different `empNum` value for every `Employee` object you ever create. **Nonstatic methods**, those methods used with object instantiations, are called **instance methods**.

Understanding when to declare fields and methods as `static` and `nonstatic` is a challenge for new programmers. Table 3-1 provides a summary.

Static	Nonstatic
In Java, <code>static</code> is a keyword. It also can be used as an adjective.	There is no keyword for <code>nonstatic</code> items. When you do not explicitly declare a field or method to be <code>static</code> , then it is <code>nonstatic</code> by default.
Static fields in a class are called class fields.	<code>Nonstatic</code> fields in a class are called instance variables.
Static methods in a class are called class methods.	<code>Nonstatic</code> methods in a class are called instance methods.

**Table 3-1** Comparison of `static` and `nonstatic` (*continues*)

*(continued)*

124

**Static**

When you use a static field or method, you do not use an object; for example:  
`JOptionPane.showDialog();`

When you create a class with a static field and instantiate 100 objects, only one copy of that field exists in memory.

When you create a static method in a class and instantiate 100 objects, only one copy of the method exists in memory and the method does not receive a `this` reference.

Static class variables are not instance variables. The system allocates memory to hold class variables once per class, no matter how many instances of the class you instantiate. The system allocates memory for class variables the first time it encounters a class, and every instance of a class shares the same copy of any static class variables.

**Nonstatic**

When you use a nonstatic field or method, you must use an object; for example:  
`System.out.println();`

When you create a class with a nonstatic field and instantiate 100 objects, then 100 copies of that field exist in memory.

When you create a nonstatic method in a class and instantiate 100 objects, only one copy of the method exists in memory, but the method receives a `this` reference that contains the address of the object currently using it.

Instance fields and methods are nonstatic. The system allocates a separate memory location for each nonstatic field in each instance.

**Table 3-1** Comparison of static and nonstatic



Table 3-1 mentions the `this` reference. You will learn about the `this` reference in the next chapter.

When a class contains data fields, you want a way to assign values to them. For an `Employee` class with an `empNum` field, you need a method with which to set the `empNum`. Figure 3-17 shows a method named `setEmpNum()` that sets the value of an `Employee`'s `empNum`. In Java, methods that set values for an object conventionally start with the prefix *set*. Using this three-letter prefix with your method names is not required, but it is conventional. The method is a `void` method because there is no need to return any value to a calling method. The method receives an integer, locally called `emp`, to be assigned to `empNum`.

```
public void setEmpNum(int emp)
{
    empNum = emp;
}
```

**Figure 3-17** The `setEmpNum()` method



Methods that set values are called **mutator methods**; methods that retrieve values are called **accessor methods**.

Figure 3-18 shows the complete `Employee` class containing one private data field and two public methods, all of which are nonstatic. This class becomes the model for a new data type named `Employee`; when `Employee` objects eventually are created, each will have its own `empNum` field, and each will have access to two methods—one that provides a value for its `empNum` field and another that retrieves the value stored there.

```
public class Employee
{
    private int empNum;
    public int getEmpNum()
    {
        return empNum;
    }
    public void setEmpNum(int emp)
    {
        empNum = emp;
    }
}
```

**Figure 3-18** The `Employee` class with one field and two methods

When you create a class like `Employee`, you can compile it, and you should to locate typographical errors. However, you cannot execute the class because it does not contain a `main()` method. A class like `Employee` is intended to be used as a data type for objects within other applications, as you will see in the next section.

## TWO TRUTHS & A LIE

### Creating Instance Methods in a Class

1. The keyword `static` is used with classwide methods, but not for methods that “belong” to objects.
2. When you create a class from which objects will be instantiated, most methods are nonstatic because they are associated with individual objects.
3. Static methods are instance methods.

The false statement is #3. Nonstatic methods are instance methods; static methods are class methods.

## Declaring Objects and Using Their Methods

Declaring a class does not create any actual objects. A class is just an abstract description of what an object will be like if any objects are ever actually instantiated. Just as you might understand all the characteristics of an item you intend to manufacture long before the first item rolls off the assembly line, you can create a class with fields and methods long before you instantiate any objects that are members of that class.

A two-step process creates an object that is an instance of a class. First, you supply a type and an identifier—just as when you declare any variable—and then you allocate computer memory for that object. For example, you might declare an integer as `int someValue`; and you might declare an `Employee` as follows:

```
Employee someEmployee;
```

In this statement, `someEmployee` stands for any legal identifier you choose to represent an `Employee`.

When you declare an integer as `int someValue`, you notify the compiler that an integer named `someValue` will exist, and you reserve computer memory for it at the same time. When you declare the `someEmployee` instance of the `Employee` class, you are notifying the compiler that you will use the identifier `someEmployee`. However, you are not yet setting aside computer memory in which the `Employee` named `someEmployee` might be stored—that is done automatically only for primitive type variables. To allocate the needed memory for an object, you must use the **new operator**. Two statements that actually set aside enough memory to hold an `Employee` are as follows:

```
Employee someEmployee;  
someEmployee = new Employee();
```



You first learned about the `new` operator when you created a `Scanner` object in Chapter 2.

You can also declare and reserve memory for `someEmployee` in one statement, as in the following:

```
Employee someEmployee = new Employee();
```

In this statement, `Employee` is the object's type (as well as its class), and `someEmployee` is the name of the object. In this statement, `someEmployee` becomes a **reference to the object**—the name for a memory address where the object is held. Every object name is also a reference—that is, a computer memory location. In Chapter 2, you learned that a class like `Employee` is a *reference type*.

The equal sign is the assignment operator, so a value is being assigned to `someEmployee` in the declaration. The `new` operator is allocating a new, unused portion of computer memory for `someEmployee`. The value that the statement is assigning to `someEmployee` is a memory address at which `someEmployee` is to be located. You do not need to be concerned with what the actual memory address is—when you refer to `someEmployee`, the compiler locates it at the appropriate address for you.

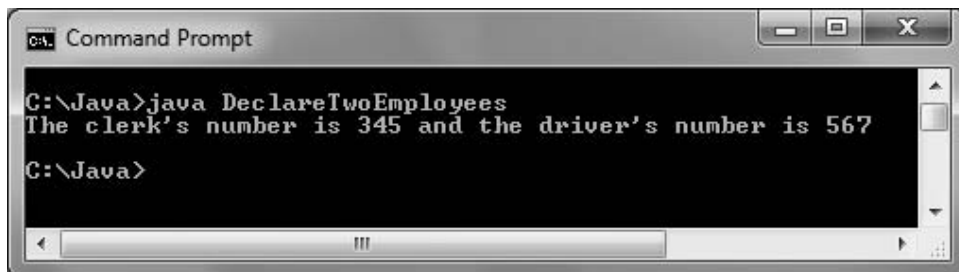


The final portion of the statement after the `new` operator, `Employee()`, with its parentheses, looks suspiciously like a method name. In fact, it is the name of a method that constructs an `Employee` object. The `Employee()` method is a **constructor**, a special type of method that creates and initializes objects. You can write your own constructor, and you will learn how later in this chapter. However, when you don't write a constructor for a class, Java writes one for you, and the name of the constructor is always the same as the name of the class whose objects it constructs.

After an object has been instantiated, its methods can be accessed using the object's identifier, a dot, and a method call. For example, Figure 3-19 shows an application that instantiates two `Employee` objects. The two objects, `clerk` and `driver`, each use the `setEmpNum()` and `getEmpNum()` method one time. The `DeclareTwoEmployees` application can use these methods because they are public, and it must use them with an `Employee` object because the methods are not static. Figure 3-20 shows the output of the application.

```
public class DeclareTwoEmployees
{
    public static void main(String[] args)
    {
        Employee clerk = new Employee();
        Employee driver = new Employee();
        clerk.setEmpNum(345);
        driver.setEmpNum(567);
        System.out.println("The clerk's number is " +
            clerk.getEmpNum() + " and the driver's number is " +
            driver.getEmpNum());
    }
}
```

Figure 3-19 The `DeclareTwoEmployees` class



```
Command Prompt
C:\Java>java DeclareTwoEmployees
The clerk's number is 345 and the driver's number is 567
C:\Java>
```

Figure 3-20 Output of the `DeclareTwoEmployees` application



The program in Figure 3-19 assumes that the `Employee.java` file is stored in the same folder as the application. If the `Employee.java` file was stored in a different folder, you would need an `import` statement at the top of the file, similar to the ones you use for the `Scanner` and `JOptionPane` classes.

## Understanding Data Hiding

Within the `DeclareTwoEmployees` class, you must use the public methods `setEmpNum()` and `getEmpNum()` to be able to set and retrieve the value of the `empNum` field for each `Employee` because you cannot access the private `empNum` field directly. For example, the following statement would not be allowed:

```
c1erk.empNum = 789;
```

This statement generates the error message “`empNum` has private access in `Employee`”, meaning you cannot access `empNum` from the `DeclareTwoEmployees` class. If you made `empNum` `public` instead of `private`, a direct assignment statement would work, but you would violate an important principle of object-oriented programming—that of data hiding using encapsulation. Data fields should usually be `private`, and a client application should be able to access them only through the public interfaces—that is, through the class’s public methods. However, you might reasonably ask, “When I write an application, if I *can’t* set an object’s data field directly, but I *can* set it using a public method, what’s the difference? The field value is set either way!” Actually, the `setEmpNum()` method in the `Employee` class in Figure 3-18 *does* accept any integer value you send into it. However, you could rewrite the `setEmpNum()` method to prevent invalid data from being assigned to an object’s data fields. For example, perhaps your organization has rules for valid employee ID numbers—they must be no fewer than five digits, or they must start with a 9, for instance—or perhaps you calculate a check-digit that is appended to every employee ID number. The statements that enforce these requirements would be part of the `setEmpNum()` method.



Checking a value for validity requires decision making. You will learn more in the chapter *Making Decisions*.



A check-digit is a number appended to a field, typically an ID number or account number. The check-digit ensures that the number is valid. For example, an organization might use five-digit employee ID numbers in which the fifth digit is calculated by dividing the first four by 7 and taking the remainder. As an example, if the first four digits of your ID number are 7235, then the fifth digit is 4, the remainder when you divide the first four digits by 7. So the five-digit ID becomes 72354. Later, if you make a mistake and enter your ID into a company application as 82354, the application would divide the first four digits, 8235, by 7. The remainder is not 4, and the ID would be found invalid.

Similarly, a `get` method might control how a value is retrieved. Perhaps you do not want clients to have access to part of an employee’s ID number, or perhaps you always want to add a company code to every ID before it is returned to the client. Even when a field has no data value requirements or restrictions, making data `private` and

providing public `set` and `get` methods establishes a framework that makes such modifications easier in the future. You will not necessarily write `set` and `get` methods for every field in a class; there are some fields that clients will not be allowed to alter. Some fields will simply be assigned values, and some field values might be calculated from the values of others.



Watch the video *Classes and Objects*.

## TWO TRUTHS & A LIE

### Declaring Objects and Using Their Methods

1. When you declare an object, you give it a name and set aside enough memory for the object to be stored.
2. An object name is a reference; it holds a memory address.
3. When you don't write a constructor for a class, Java creates one for you; the name of the constructor is always the same as the name of its class.

The false statement is #1. When you declare an object, you are not yet setting aside computer memory in which the object is stored; to allocate the needed memory for an object, you must use the `new` operator.

## Organizing Classes

Most classes you create have multiple data fields and methods. For example, in addition to requiring an employee number, an `Employee` needs a last name, a first name, and a salary, as well as methods to set and get those fields. Figure 3-21 shows how you could code the data fields for `Employee`.

```
public class Employee
{
    private int empNum;
    private String empLastName;
    private String empFirstName;
    private double empSalary;
    // Methods will go here
}
```

**Figure 3-21** An `Employee` class with several data fields

Although there is no requirement to do so, most programmers place data fields in some logical order at the beginning of a class. For example, `empNum` is most likely used as a unique identifier for each employee (what database users often call a **primary key**), so it makes sense to list the employee number first in the class. An employee's last name and first name "go together," so it makes sense to store these two `Employee` components adjacently. Despite these common-sense rules, you have a lot of flexibility in how you position your data fields within any class.



A unique identifier is one that should have no duplicates within an application. For example, an organization might have many employees with the last name Johnson or a weekly salary of \$400.00, but there is only one employee with employee number 128.

Because there are two `String` components in the current `Employee` class, they might be declared within the same statement, such as the following:

```
private String empLastName, empFirstName;
```

However, it is usually easier to identify each `Employee` field at a glance if the fields are listed vertically.

You can place a class's data fields and methods in any order within a class. For example, you could place all the methods first, followed by all the data fields, or you could organize the class so that several data fields are followed by methods that use them, then several more data fields are followed by the methods that use them. This book will follow the convention of placing all data fields first so that you can see their names and data types before reading the methods that use them.

Even if the only methods in the `Employee` class started in Figure 3-21 include one `set` method and one `get` method for each instance variable, eight methods are required. Consider an employee record for most organizations and you will realize that many more fields are often required (such as address, phone number, hire date, number of dependents, and so on), as well as many more methods. Finding your way through the list can become a formidable task. For ease in locating class methods, many programmers store them in alphabetical order. Other programmers arrange values in pairs of `get` and `set` methods, an order that also results in functional groupings. Figure 3-22 shows how the complete class definition for an `Employee` might appear.

```
public class Employee
{
    private int empNum;
    private String empLastName;
    private String empFirstName;
    private double empSalary;
    public int getEmpNum()
    {
        return empNum;
    }
    public void setEmpNum(int emp)
    {
        empNum = emp;
    }
    public String getEmpLastName()
    {
        return empLastName;
    }
    public void setEmpLastName(String name)
    {
        empLastName = name;
    }
    public String getEmpFirstName()
    {
        return empFirstName;
    }
    public void setEmpFirstName(String name)
    {
        empFirstName = name;
    }
    public double getEmpSalary()
    {
        return empSalary;
    }
    public void setEmpSalary(double sal)
    {
        empSalary = sal;
    }
}
```

**Figure 3-22** The Employee class with several data fields and corresponding methods

The Employee class is still not a particularly large class, and each of its methods is very short, but it is already becoming quite difficult to manage. It certainly can support some well-placed comments, as shown in Figure 3-23.

```
// Employee.java holds employee data
// Programmer: Lynn Greenbrier
// Date: September 24, 2011
public class Employee
{
    // private data fields:
    private int empNum;
    private String empLastName;
    private String empFirstName;
    private double empSalary;

    // public get and set methods:
    public int getEmpNum()
    {
        return empNum;
    }
    public void setEmpNum(int emp)
    {
        empNum = emp;
    }
    // ...and so on
```

Figure 3-23 Start of Employee class with data fields, methods, and comments

## TWO TRUTHS & A LIE

### Organizing Classes

1. You can place a class's fields first within the class, followed by methods.
2. You can place a class's methods first within the class, followed by fields.
3. Although you can and should place comments in a Java application, you should not use them in a class from which objects will be instantiated.

The false statement is #3. You can place comments in any Java class, whether it is an application or not.

## An Introduction to Using Constructors

When you create a class, such as Employee, and instantiate an object with a statement such as the following, you are actually calling the Employee class constructor that is provided by default by the Java compiler:

```
Employee chauffeur = new Employee();
```

A constructor establishes an object; a **default constructor** is one that requires no arguments. A default constructor is created automatically by the Java compiler for any class you create whenever you do not write your own constructor.

When the prewritten, default constructor for the `Employee` class is called, it establishes one `Employee` object with the identifier provided. The automatically supplied default constructor provides the following specific initial values to an object's data fields:

- Numeric fields are set to 0 (zero).
- Character fields are set to Unicode `'\u0000'`.
- Boolean fields are set to `false`.
- Fields that are objects themselves (for example, `String` fields) are set to `null` (or empty).

If you do not want each field in an object to hold these default values, or if you want to perform additional tasks when you create an instance of a class, you can write your own constructor. Any constructor you write must have the same name as the class it constructs, and constructors cannot have a return type. You never provide a return type for a constructor—not even `void`. Normally, you declare constructors to be `public` so that other classes can instantiate objects that belong to the class. When you write a constructor for a class, you no longer have access to the automatically created version.

For example, if you want every `Employee` object to have a starting salary of \$300.00 per week, you could write the constructor for the `Employee` class that appears in Figure 3-24. Any `Employee` object instantiated will have an `empSalary` field value equal to 300.00, and the other `Employee` data fields will contain the default values. Even if you do not initialize an object's field, it always contains the default value, and even though you might want the field to hold the default value, you still might prefer to explicitly initialize the field for clarity.

```
public Employee()  
{  
    empSalary = 300.00;  
}
```

**Figure 3-24** The `Employee` class constructor



The `Employee` class constructor in Figure 3-24 takes no parameters. Therefore, it is a default constructor. You will learn about nondefault constructors that take parameters in the next chapter.

You can write any Java statement in a constructor. Although you usually have no reason to do so, you could display a message from within a constructor or perform any other task.

You can place the constructor anywhere inside the class, outside of any other method. Typically, a constructor is placed with the other methods. Often, programmers list the constructor first because it is the first method used when an object is created.

You are never required to write a constructor for a class; Java provides you with a default version if the class contains no explicit constructor.

134



A class can contain multiple constructors. You will learn how to overload constructors in the next chapter.



Watch the video *Constructors*.

## TWO TRUTHS & A LIE

### An Introduction to Using Constructors

1. In Java, you cannot write a default constructor; it must be supplied for you automatically.
2. The automatically supplied default constructor sets all numeric fields to 0, character fields to Unicode `'\u0000'`, Boolean fields to `false`, and fields that are object references to `null`.
3. When you write a constructor, it must have the same name as the class it constructs, and it cannot have a return type.

The false statement is #1. A default constructor is one that takes no parameters. If you do not create a constructor for a class, Java creates a default constructor for you. However, you can create a default constructor that replaces the automatically supplied one.

## Understanding that Classes are Data Types

The classes that you create become data types. Java has eight built-in primitive data types such as `int` and `double`. You do not have to define those types; the creators of Java have already done so. For example, when the `int` type was first created, the programmers who designed it had to think of the following:

Q: What shall we call it?

A: `int`.



Q: What are its attributes?

A: An `int` is stored in four bytes; it holds whole-number values.

Q: What methods are needed by `int`?

A: A method to assign a value to a variable (for example, `num = 32;`).

Q: Any other methods?

A: Some operators to perform arithmetic with variables (for example, `num + 6`).

Q: Any other methods?

A: Of course, there are even more attributes and methods of an `int`, but these are a good start.

Your job in constructing a new data type is similar. If you need a class for employees, you should ask:

Q: What shall we call it?

A: `Employee`.

Q: What are its attributes?

A: It has an integer ID number, a `String` last name, and a `double` salary.

Q: What methods are needed by `Employee`?

A: A method to assign values to a member of this class (for example, one `Employee`'s ID number is 3232, her last name is "Walters", and her salary is 30000).

Q: Any other methods?

A: A method to display data in a member of this class (for example, display one `Employee`'s data).

Q: Any other methods?

A: Probably, but this is enough to get started.



Programmers sometimes refer to classes as abstract data types, or ADTs. An **abstract data type** is a type whose implementation is hidden and accessed through its public methods. A class can also be called a **programmer-defined data type**; in other words, it is a type that is not built into the language.

When you declare a primitive type object, you provide its type and an identifier. When you declare an object from one of your classes, you do the same. After each exists, you can use them in very similar ways. For example, suppose you declare an `int` named `myInt` and an `Employee` named `myEmployee`. Then each can be passed into a method, returned from a method, or assigned to another object of the same data type.


For example, Figure 3-25 shows a program in which the `main()` method uses two other methods. One method accepts an `Employee` as a parameter, and the other returns an `Employee`. (The `Employee` class is defined in Figure 3-22.) Figure 3-26 shows a typical

execution. You can see in this sample program that an `Employee` is passed into and out of methods just like a primitive object would be. Classes are not mysterious; they are just new data types that you invent.

136

```
import java.util.Scanner;
class MethodsThatUseAnEmployee
{
    public static void main(String args[])
    {
        Employee myEmployee;
        myEmployee = getEmployeeData();
        displayEmployee(myEmployee);
    }
    public static Employee getEmployeeData()
    {
        Employee tempEmp = new Employee();
        int id;
        double sal;
        Scanner input = new Scanner(System.in);
        System.out.print("Enter employee ID ");
        id = input.nextInt();
        tempEmp.setEmpNum(id);
        System.out.print("Enter employee salary ");
        sal = input.nextDouble();
        tempEmp.setEmpSalary(sal);
        return tempEmp;
    }
    public static void displayEmployee(Employee anEmp)
    {
        System.out.println("\nEmployee #" + anEmp.getEmpNum() +
            " Salary is " + anEmp.getEmpSalary());
    }
}
```

Figure 3-25 The `MethodsThatUseAnEmployee` application



```
C:\Java>java MethodsThatUseAnEmployee
Enter employee ID 3412
Enter employee salary 750.00

Employee #3412 Salary is 750.0
C:\Java>
```

Figure 3-26 Typical execution of the `MethodsThatUseAnEmployee` application



Notice in the application in Figure 3-25 that the `Employee` declared in the `main()` method is not constructed there. An `Employee` is constructed in the `getEmployeeData()` method and passed back to the `main()` method, where it is assigned to the `myEmployee` reference. The `Employee` constructor could have been called in `main()`, but the values assigned would have been overwritten after the call to `getEmployeeData()`.

## TWO TRUTHS & A LIE

### Understanding that Classes are Data Types

1. When you declare a primitive variable or instantiate an object from a class, you provide both a type and an identifier.
2. Unlike a primitive variable, an instantiated object cannot be passed into or returned from a method.
3. The address of an instantiated object can be assigned to a declared reference of the same type.

The false statement is #2. An instantiated object can be passed into or returned from a method.

## You Do It

### Creating a Static Method That Requires No Arguments and Returns No Values

Event Handlers Incorporated is a company that assists its clients in planning and hosting social events and business meetings. In this section, you will create a new class named `SetUpSite`, which you will eventually use to set up one `EventSite` object that represents the site where an event can be held. For now, the class will contain a `main()` method and a `statementOfPhilosophy()` method for Event Handlers Incorporated.

#### To create the `SetUpSite` class:

1. Open a new document in your text editor.
2. Type the following shell class to create a `SetUpSite` class and an empty `main()` method:

```
public class SetUpSite
{
    public static void main(String[] args)
    {
    }
}
```

3. Between the curly braces of the `main()` method, type the following:  
**`statementOfPhilosophy();`**

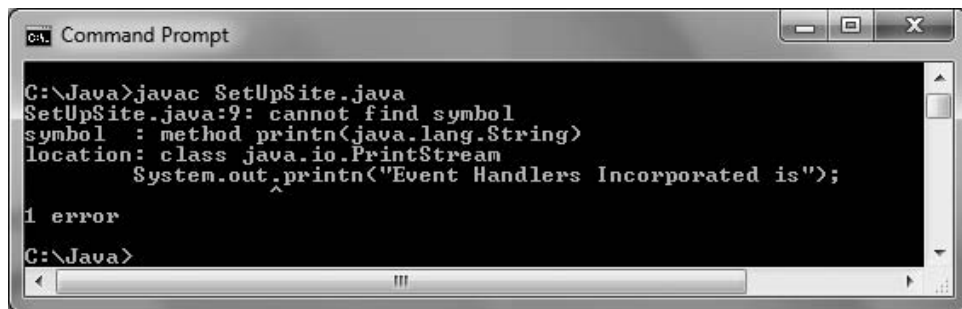
This statement calls a method named `statementOfPhilosophy()`.

4. Place the `statementOfPhilosophy()` method outside the `main()` method, just before the closing curly brace for the `SetUpSite` class code:

```
public static void statementOfPhilosophy()  
{  
    System.out.println("Event Handlers Incorporated is");  
    System.out.println("dedicated to making your event");  
    System.out.println("a most memorable one.");  
}
```

5. Save the file as **`SetUpSite.java`**.
6. At the command line, compile the application by typing **`javac SetUpSite.java`**.

If you receive any error messages, you must correct their cause. For example, Figure 3-27 shows the error message received when `println()` is spelled incorrectly once within the `SetUpSite.java` file. Notice the message indicates that the file is `SetUpSite.java`, the line on which the error occurs is line 9, and the error is “cannot find symbol”, followed by the name of the symbol that the compiler does not understand: “symbol: method `printn` (java.lang.String)”.



**Figure 3-27** Error message received when `println` is incorrectly spelled

To help you, Java tells you where the error might be: “location: class `java.io.PrintStream`”. Java assumes the error is in the `PrintStream` class because you are using `System.out`, which is a `PrintStream` object, and the compiler can’t find a method with the name `printn()` in that class. The compiler displays the offending line, and a caret appears just below the point at which the compiler could proceed no further. When you view this error message, you should notice the misspelling of the `println()` method name. To correct the spelling error, return to the `SetUpSite.java` file, fix the mistake, save the file, and then compile it again.



If you misspelled `println()`, but did not notice the typographical error when you read the message, or did not know how the method name should be spelled, your next course of action is to search the Java documentation for methods contained in the `PrintStream` class. All the Java documentation can be found at <http://java.sun.com>.

- After the application compiles successfully, execute it using the command `java SetupSite`. Your output should look like Figure 3-28.

139

```

C:\Java>java SetupSite
Event Handlers Incorporated is
dedicated to making your event
a most memorable one.

C:\Java>

```

**Figure 3-28** Output of the SetupSite application

## Calling a Static Method from Another Class

Next, you will see how to call the `statementOfPhilosophy()` method from a method within another class.

### To call a static method from a method within another class:

- First, open a new document in your text editor, and then enter the following class in which the `main()` method calls the `statementOfPhilosophy()` method that resides in a different class:

```

public class TestStatement
{
    public static void main(String[] args)
    {
        System.out.println("Calling method from another class");
        SetupSite.statementOfPhilosophy();
    }
}

```

- Save the file as `TestStatement.java`. Compile the application with the command `javac TestStatement.java`.



If you want one class to call a method of another class, both classes should reside in the same folder. If they are not saved in the same folder, when you compile the calling class, your compiler issues the error message "cannot find symbol", and the symbol it names is the missing class you tried to call.

- Execute the application with the command `java TestStatement`. Your output should look like Figure 3-29.



```
C:\Java>java TestStatement
Calling method from another class
Event Handlers Incorporated is
dedicated to making your event
a most memorable one.

C:\Java>
```

Figure 3-29 Output of the TestStatement application

## Creating a Static Method That Accepts Arguments and Returns Values

Next, you will add a method to the `SetUpSite` class; the new method both receives a parameter and returns a value. The purpose of the method is to accept the current year and calculate how long Event Handlers has been in business.

### To add a method that receives a parameter and returns a value:

1. Open the `SetUpSite.java` file in the text editor, and then change the class name to `SetUpSite2`. Immediately save the file as `SetUpSite2`.
2. Add three integer declarations as the first statements following the opening curly brace of the `main()` method. One is a constant that holds the year Event Handlers was established. The other two are variables that hold the current year, which will be entered by a user, and the age of the organization, which will be calculated from the other two values.

```
final int FOUNDED_YEAR = 1977;
int currentYear;
int age;
```

3. As the first line in the file, add an import statement that will allow the use of the `Scanner` class:

```
import java.util.Scanner;
```



Instead of importing the `Scanner` class to provide console input, you could substitute `JOptionPane` and include program statements that provide GUI input. The input process can use other techniques too, such as getting data from a storage device—you will learn about file input in the chapter *File Input and Output*. The concept of input (getting data into memory from the outside) is the same no matter what specific technique or type of hardware device you use.

4. In the `main()` method, following the constant and variable declarations, add the statement that associates a `Scanner` object with the `System.in` object:

```
Scanner input = new Scanner(System.in);
```

5. In the `main()` method, after the call to the `statementOfPhilosophy()` method, add a prompt for the current year and the statement that retrieves it from the keyboard:

```
System.out.print("Enter the current year as a four-digit number ");  
currentYear = input.nextInt();
```

6. Following the input statement, add a call to a method that will receive the founding and current years as parameters and that will return the age of the organization:

```
age = calculateAge(FOUNDED_YEAR, currentYear);
```

7. Type the following to display information about the number of years the company has been in business:

```
System.out.println("Founded in " + FOUNDED_YEAR);  
System.out.println("Serving you for " + age + " years ");
```

8. Now you will write the `calculateAge()` method. Position the insertion point after the closing brace of the `statementOfPhilosophy()` method, press **Enter** to start a new line before the closing brace of the program, and then enter the `calculateAge()` method as follows:

```
public static int calculateAge(int originYear, int currDate)  
{  
    int years;  
    years = currDate - originYear;  
    return years;  
}
```

The `calculateAge()` method receives two integer values. Note that the names `originYear` and `currDate` do not possess the same identifiers as the arguments passed in from the `main()` method, although they could. Notice also that the method declaration indicates an `int` value will be returned. The `calculateAge()` method performs the necessary subtraction and returns the difference to the calling function.



The `calculateAge()` method is static because no `SetUpSite2` objects need to be created to use it; it is a class method.

9. Save the file (as `SetUpSite2.java`), compile it, and correct any errors. Execute the application and confirm that the results are correct. Figure 3-30 shows a typical execution.



```
ca. Command Prompt
C:\Java>java SetupSite2
Event Handlers Incorporated is
dedicated to making your event
a most memorable one.
Enter the current year as a four-digit number 2012
Founded in 1977
Serving you for 35 years
C:\Java>
```

Figure 3-30 Typical execution of the SetupSite2 application

## Creating a Class That Contains Instance Fields and Methods

Next, you will create a class to store information about event sites for Event Handlers Incorporated.

### To create the class:

1. Open a new document in your text editor.
  2. Type the following class header and the curly braces to surround the class body:
- ```
public class EventSite
{
}
```
3. Type **private int siteNumber**; between the curly braces to insert the private data field that will hold an integer site number for each event site used by the company.
  4. Within the EventSite class's curly braces and after the declaration of the siteNumber field, enter the following `getSiteNumber()` method to return the site number to any calling class:

```
public int getSiteNumber()
{
    return siteNumber;
}
```

5. Add the following method to the file after the final curly brace for the `getSiteNumber()` method, but prior to the closing curly brace for the EventSite class:

```
public void setSiteNumber(int n)
{
    siteNumber = n;
}
```

The parameter *n* represents any number sent to this method.

6. Save the file as **EventSite.java**, compile it, and then correct any syntax errors. (You cannot run this file as a program because it does not contain a `public static main()` method.) The complete class appears in Figure 3-31.



```
public class EventSite
{
    private int siteNumber;
    public int getSiteNumber()
    {
        return siteNumber;
    }
    public void setSiteNumber(int n)
    {
        siteNumber = n;
    }
}
```

**Figure 3-31** The EventSite class



Notice that the methods in the `EventSite` class are not static. That means they must be used with an `EventSite` object.

## Creating a Class That Instantiates Objects of Another Class

Next, you will modify the `SetUpSite2` application so that it instantiates an `EventSite` object.

### To instantiate an object:

1. Open the `SetUpSite2.java` file. Change the class name to `SetUpSite3`, then immediately save the file as `SetUpSite3.java`.
2. Following the `Scanner` declaration within the `main()` method, add a statement that declares and allocates memory for a new `EventSite` object named `oneSite`:

```
EventSite oneSite = new EventSite();
```

3. Just below the newly entered declaration for `oneSite`, add an integer declaration as follows:

```
int siteNum;
```

4. Below the statements that prompt for and receive the year, add statements that prompt for and receive the site number:

```
System.out.print("Enter the event site number ");  
siteNum = input.nextInt();
```

5. Next, call the method `setSiteNumber()` to set the site number for `oneSite`:

```
oneSite.setSiteNumber(siteNum);
```

6. After the statement that displays the age of the company, enter the statement that displays the site number by calling the `getSiteNumber()` method from within the `println()` method:

```
System.out.println("The site number is " +  
oneSite.getSiteNumber());
```

7. Save the program file (as `SetUpSite3.java`), and compile the program by typing **javac `SetUpSite3.java`**.
8. Execute the program by typing **java `SetUpSite3`**. Enter values appropriately when you are prompted. Figure 3-32 shows a typical execution.



```
C:\Java>java SetUpSite3
Event Handlers Incorporated is
dedicated to making your event
a most memorable one.
Enter the current year as a four-digit number 2012
Enter the event site number 341
Founded in 1977
Serving you for 35 years
The site number is 341
C:\Java>_
```

**Figure 3-32** Typical execution of the `SetUpSite3` application

## Adding a Constructor to a Class

Next, you will add a default constructor to the `EventSite` class and demonstrate that it is called automatically when you instantiate an `EventSite` object.

### To add a constructor to the `EventSite` class:

1. Open the **`EventSite.java`** file in your text editor.
2. Following the declaration of the `siteNumber` field, insert the following default constructor function that sets any `EventSite` `siteNumber` to 999 upon construction:

```
public EventSite()
{
    siteNumber = 999;
}
```

3. Save the file (as `EventSite.java`), compile it, and correct any errors.
4. Open a new text file and create a test class named `TestConstructor` as follows:

```
public class TestConstructor
{
    public static void main(String[] args)
    {
        EventSite oneSite = new EventSite();
        System.out.println("Site number " +
            oneSite.getSiteNumber());
    }
}
```

5. Save the file as **TestConstructor.java**, compile the file, and correct any syntax errors. Execute the program to confirm that when the `oneSite` object of type `EventSite` is declared, the automatically called constructor assigns the appropriate initial value, as shown in Figure 3-33.



```
C:\Java>java TestConstructor
Site number 999
C:\Java>
```

**Figure 3-33** Output of the `TestConstructor` application

## Creating a More Complete Class

In the next steps, you will add data fields and methods to the `EventSite` class to make it more complete.

### To make a more complete class:

1. Open the **EventSite.java** file. Change the class name to **CompleteEventSite**. Immediately save the file as **CompleteEventSite.java**.
2. Add two more fields to the class—a `double` that holds the hourly fee for using the event site and a `String` that is the name of the site. For example, the Grand Ballroom might cost \$100 an hour. Add get and set methods for each new field.
3. Modify the `EventSite` constructor name to the name of the new class. Add statements that initialize the new fields to appropriate default values.
4. Save the file, compile it, and correct any errors.
5. Write a program named `TestCompleteEventSite` that demonstrates that each method and the constructor all work correctly. Save the file as **TestCompleteEventSite.java**.

## Don't Do It

- Don't place a semicolon at the end of a method header. After you get used to putting semicolons at the end of every statement, it's easy to start putting them in too many places. Method headers never end in a semicolon.
- Don't think "default constructor" means only the automatically supplied constructor. Although a class's automatically supplied constructor is a default constructor, so is any constructor you create that accepts no parameters.

- Don't think that a class's methods must accept its own fields' values as parameters or return values to its own fields. When a class contains both fields and methods, each method has direct access to every field within the class.
- Don't create a class method that has a parameter with the same identifier as a class field—yet. If you do, you will only be allowed to access the local variable within the method, and you will not be able to access the field. You will be able to use the same identifier and still access both values after you read the next chapter. For now, make sure that the parameter in any class method has a different identifier from any class field.

## Key Terms

A **method** is a program module that contains a series of statements that carry out a task.

When you **invoke** or **call** a method, you execute it.

The **calling method** makes a **method call** that invokes the **called method**.

A **client method** is a method that calls another.

The **method header** is the first line of the method and contains information about how other methods can interact with it.

A **declaration** is another name for a method header.

A **method body** is the set of statements between curly braces that follow the header and that carry out the method's actions.

**Implementation** describes the actions that execute within a method; the method body.

A **stub** is a method that contains no statements; programmers create stubs as temporary placeholders during the program development process.

**Abstraction** is the programming feature that allows you to use a method name to encapsulate a series of statements.

A **return type** indicates the type of data that, upon completion of the method, is sent back to its calling method.

To **return a value** is to send the value from a called method back to the calling method.

**Access modifier** is sometimes used as another term for *access specifier*.

A **fully qualified identifier** includes a class name and a dot before the identifier.

**Arguments** are data items sent to methods in a method call.

**Parameters** are the data items received by a method.

**Implementation hiding** is a principle of object-oriented programming that describes the encapsulation of method details within a class.

The **interface** to a method includes the method's return type, name, and arguments. It is the part that a client sees and uses.

A **black box** is a device you can use without understanding how it works.

A **local variable** is known only within the boundaries of a method.

A method's **signature** is the combination of the method name and the number, types, and order of arguments.

**Actual parameters** are the arguments in a method call.

**Formal parameters** are the variables in a method declaration that accept the values from actual parameters.

A **return statement** ends a method and frequently sends a value from a called method back to the calling method.

A **method's type** is its return type.

**Unreachable statements** are those that cannot be executed because the logical path can never encounter them; an unreachable statement causes a compiler error.

**Dead code** is a set of statements that are logically unreachable.

An **is-a relationship** is the relationship between an object and the class of which it is a member.

An **instantiation** of a class is an object; in other words, it is one tangible example of a class.

The **instance variables** of a class are its data components.

**Fields** are data variables declared in a class outside of any method.

A **class client** or **class user** is an application or class that instantiates objects of another prewritten class.

Classes can be **extended**, or used as a basis for any other class.

Assigning **private access** to a field means that no other classes can access the field's values, and only methods of the same class are allowed to set, get, or otherwise use private variables.

**Information hiding** is the object-oriented programming principle used when creating private access for data fields; a class's private data can be changed or manipulated only by a class's own methods and not by methods that belong to other classes.

**Nonstatic methods**, those methods used with object instantiations, are called **instance methods**.

**Mutator methods** set values.

**Accessor methods** retrieve values.

The **new operator** allocates the memory needed to hold an object.

A **reference to an object** is the name for a memory address where the object is held.

A **constructor** is a method that establishes an object.

A **primary key** is a unique identifier for data within a database.

A **default constructor** is one that is created automatically by the Java compiler.

An **abstract data type** is a type whose implementation is hidden and accessed through its public methods.

A **programmer-defined data type** is one that is created by a programmer and not built into the language.

## Chapter Summary

- A method is a series of statements that carry out a task. Methods must include a declaration (or header or definition), an opening curly brace, a body, and a closing curly brace. A method declaration contains optional access specifiers, the return type for the method, the method name, an opening parenthesis, an optional list of parameters, and a closing parenthesis.
- When you write the method declaration for a method that can receive a parameter, you need to include the parameter type and a local name for the parameter within the method declaration parentheses. You can pass multiple arguments to methods by listing the arguments separated by commas within the call to the method. The arguments you send to the method must match (both in number and in type) the parameters listed in the method declaration.
- The return type for a method (the method's type) can be any Java type, including `void`. You use a `return` statement to send a value back to a calling method.
- Objects have attributes and methods associated with them. Nonstatic instance methods are used with objects. You can send messages to objects using their methods.
- A class header contains an optional access specifier, the keyword `class`, and any legal identifier you choose for the name of your class.
- The instance variables, or fields, of a class are placed as statements within the class's curly braces. Fields and methods used with object instantiations are nonstatic.
- To create an object that is an instance of a class, you supply a type and an identifier, and then you allocate computer memory for that object using the `new` operator and the class constructor. With well-written object-oriented programming methods, using implementation hiding—or the encapsulation of method details within a class—means that the calling method needs to understand only the interface to the called method.
- Programmers can organize their classes in many ways. Fields can be placed before or after methods, and methods can be placed in any logical order.
- A constructor establishes an object and provides specific initial values for the object's data fields. A constructor always has the same name as the class of which it is a member. By default, numeric fields are set to 0 (zero), character fields are set to Unicode `'\u0000'`, Boolean fields are set to `false`, and object type fields are set to `null`.
- A class is an abstract, programmer-defined data type.

## Review Questions

1. In Java, methods must include all of the following except \_\_\_\_\_.
  - a. a declaration
  - b. a call to another method
  - c. curly braces
  - d. a body
2. All method declarations contain \_\_\_\_\_.
  - a. the keyword `static`
  - b. one or more explicitly named access specifiers
  - c. arguments
  - d. parentheses
3. A `public static` method named `computeSum()` is located in `classA`. To call the method from within `classB`, use the statement \_\_\_\_\_.
  - a. `computeSum(classB);`
  - b. `classB(computeSum());`
  - c. `classA.computeSum();`
  - d. You cannot call `computeSum()` from within `classB`.
4. Which of the following method declarations is correct for a `static` method named `displayFacts()` if the method receives an `int` argument?
  - a. `public static int displayFacts()`
  - b. `public void displayFacts(int data)`
  - c. `public static void displayFacts(int data)`
  - d. Two of these are correct.
5. The method with the declaration `public static int aMethod(double d)` has a method type of \_\_\_\_\_.
  - a. `static`
  - b. `int`
  - c. `double`
  - d. You cannot determine the method type.
6. Which of the following is a correct call to a method declared as `public static void aMethod(char code)`?
  - a. `void aMethod();`
  - b. `void aMethod('V');`
  - c. `aMethod(char 'M');`
  - d. `aMethod('Q');`
7. A method is declared as `public static void showResults(double d, int i)`. Which of the following is a correct method call?
  - a. `showResults(double d, int i);`
  - b. `showResults(12.2, 67);`
  - c. `showResults(4, 99.7);`
  - d. Two of these are correct.

8. The method with the declaration `public static char procedure(double d)` has a method type of \_\_\_\_\_.
  - a. `public`
  - b. `static`
  - c. `char`
  - d. `double`
9. The method `public static boolean testValue(int response)` returns \_\_\_\_\_.
  - a. a `boolean` value
  - b. an `int` value
  - c. no value
  - d. You cannot determine what is returned.
10. Which of the following could be the last legally coded line of a method declared as `public static int getVal(double sum)`?
  - a. `return;`
  - b. `return 77;`
  - c. `return 2.3;`
  - d. Any of these could be the last coded line of the method.
11. The nonstatic data components of a class often are referred to as the \_\_\_\_\_ of that class.
  - a. access types
  - b. instance variables
  - c. methods
  - d. objects
12. Objects contain methods and data items, which are also known as \_\_\_\_\_.
  - a. fields
  - b. functions
  - c. themes
  - d. instances
13. You send messages or information to an object through its \_\_\_\_\_.
  - a. fields
  - b. methods
  - c. classes
  - d. type
14. A program or class that instantiates objects of another prewritten class is a(n) \_\_\_\_\_.
  - a. class client
  - b. superclass
  - c. object
  - d. patron
15. The body of a class is always written \_\_\_\_\_.
  - a. in a single line, as the first statement in a class
  - b. within parentheses
  - c. between curly braces
  - d. as a method call



16. Most class data fields are \_\_\_\_\_.
- a. `private`
  - b. `public`
  - c. `static`
  - d. `final`
17. The concept of allowing a class's private data to be changed only by a class's own methods is known as \_\_\_\_\_.
- a. structured logic
  - b. object orientation
  - c. information hiding
  - d. data masking
18. Suppose you declare an object as `Book thisBook;`. Before you store data in `thisBook`, you \_\_\_\_\_.
- a. also must explicitly allocate memory for it
  - b. need not explicitly allocate memory for it
  - c. must explicitly allocate memory for it only if it has a constructor
  - d. can declare it to use no memory
19. If a class is named `Student`, the class constructor name is \_\_\_\_\_.
- a. any legal Java identifier
  - b. any legal Java identifier that begins with S
  - c. `StudentConstructor`
  - d. `Student`
20. If you use the automatically supplied default constructor when you create an object, \_\_\_\_\_.
- a. numeric fields are set to 0 (zero)
  - b. character fields are set to blank
  - c. Boolean fields are set to `true`
  - d. All of these are true.

## Exercises

1. Create an application named `TestMethods` whose `main()` method holds two integer variables. Assign values to the variables. In turn, pass each value to methods named `displayIt()`, `displayItTimesTwo()`, and `displayItPlusOneHundred()`. Create each method to perform the task its name implies. Save the application as **`TestMethods.java`**.
2. a. Create an application named `Numbers` whose `main()` method holds two integer variables. Assign values to the variables. Pass both variables to methods named `sum()` and `difference()`. Create the methods `sum()` and `difference()`; they compute the sum of and difference between the values of two arguments, respectively. Each method should perform the appropriate computation and display the results. Save the application as **`Numbers.java`**.

- b. Add a method named `product()` to the `Numbers` class. The `product()` method should compute the multiplication product of two integers, but not display the answer. Instead, it should return the answer to the calling method, which displays the answer. Save the application as **Numbers2.java**.
3. Create a class named `Eggs`. Its `main()` method holds an integer variable named `numberOfEggs` to which you will assign a value entered by a user at the keyboard. Create a method to which you pass `numberOfEggs`. The method displays the eggs in dozens; for example, 50 eggs is 4 full dozen (with 2 eggs remaining). Save the application as **Eggs.java**.
4.
  - a. Create a class named `Exponent`. Its `main()` method accepts an integer value from a user at the keyboard, and in turn passes the value to a method that squares the number (multiplies it by itself) and to a method that cubes the number (multiplies it by itself twice). The `main()` method displays the results. Create the two methods that respectively square and cube an integer that is passed to them, returning the calculated value. Save the application as **Exponent.java**.
  - b. Modify the `Exponent` program so that the cubing method calls the square method, then multiplies that result by the numbers to calculate the cubed value that it returns. Save the application as **Exponent2.java**.
5. Create an application that contains a method that computes the final price for a sales transaction and returns that value to a calling method. The method requires three arguments: product price, salesperson commission rate, and customer discount rate. A product's final price is the original price plus the commission amount minus the discount amount; the customer discount is taken as a percentage of the total price after the salesperson commission has been added to the original price. Write a `main()` method that prompts the user for the price of an item, the salesperson's commission expressed as a percentage, and the customer discount expressed as a percentage, and that then passes the values to the method. Save the application as **Calculator.java**.
6. Write an application that displays the result of dividing two numbers and displays any remainder. The `main()` method prompts the user for values and sends them to the dividing method; the dividing method performs the calculation and displays the results. Save the application as **Divide.java**.
7. Write an application that calculates and displays the weekly salary for an employee. The `main()` method prompts the user for an hourly pay rate, regular hours, and overtime hours. Create a separate method to calculate overtime pay, which is regular hours times the pay rate plus overtime hours times 1.5 times the pay rate; return the result to the `main()` method to be displayed. Save the program as **Salary.java**.
8. Write an application that calculates and displays the amount of money a user would have if his or her money could be invested at 5% interest for one year. Create a method that prompts the user for the starting value of the investment and returns it to the calling program. Call a separate method to do the calculation and return the result to be displayed. Save the program as **Interest.java**.

9.
  - a. Create a class named `Pizza`. Data fields include a `String` for toppings (such as “pepperoni”), an integer for diameter in inches (such as 12), and a `double` for price (such as 13.99). Include methods to get and set values for each of these fields. Save the class as **`Pizza.java`**.
  - b. Create an application named `TestPizza` that instantiates one `Pizza` object and demonstrates the use of the `Pizza` set and get methods. Save this application as **`TestPizza.java`**.
10.
  - a. Create a class named `Student`. A `Student` has fields for an ID number, number of credit hours earned, and number of points earned. (For example, many schools compute grade point averages based on a scale of 4, so a three-credit-hour class in which a student earns an A is worth 12 points.) Include methods to assign values to all fields. A `Student` also has a field for grade point average. Include a method to compute the grade point average field by dividing points by credit hours earned. Write methods to display the values in each `Student` field. Save this class as **`Student.java`**.
  - b. Write a class named `ShowStudent` that instantiates a `Student` object from the class you created and assign values to its fields. Compute the `Student` grade point average, and then display all the values associated with the `Student`. Save the application as **`ShowStudent.java`**.
  - c. Create a constructor for the `Student` class you created. The constructor should initialize each `Student`’s ID number to 9999, his or her points earned to 12, and credit hours to 3 (resulting in a grade point average of 4.0). Write a program that demonstrates that the constructor works by instantiating an object and displaying the initial values. Save the application as **`ShowStudent2.java`**.
11.
  - a. Create a class named `Checkup` with fields that hold a patient number, two blood pressure figures (systolic and diastolic), and two cholesterol figures (LDL and HDL). Include methods to get and set each of the fields. Include a method named `computeRatio()` that divides LDL cholesterol by HDL cholesterol and displays the result. Include an additional method named `explainRatio()` that explains that HDL is known as “good cholesterol” and that a ratio of 3.5 or lower is considered optimum. Save the class as **`Checkup.java`**.
  - b. Create a class named `TestCheckup` whose `main()` method declares four `Checkup` objects. Call a `getData()` method four times. Within the method, prompt a user for values for each field for a `Checkup`, and return a `Checkup` object to the `main()` method where it is assigned to one of `main()`’s `Checkup` objects. Then, in `main()`, pass each `Checkup` object in turn to a `showValues()` method that displays the data. Blood pressure values are usually displayed with a slash between the systolic and diastolic numbers. (Typical blood pressure values are 110/78 or 130/90.) With the cholesterol figures, display the explanation of the cholesterol ratio calculation. (Typical cholesterol values are 100 and 40 or 180 and 70.) Save the application as **`TestCheckup.java`**.

12.
  - a. Create a class named `Invoice` that contains fields for an item number, name, quantity, price, and total cost. Create instance methods that set the item name, quantity, and price. Whenever the price or quantity is set, recalculate the total (price times quantity). Also include a `displayLine()` method that displays the item number, name, quantity, price, and total cost. Save the class as **Invoice.java**.
  - b. Create a class named `TestInvoice` whose `main()` method declares three `Invoice` items. Create a method that prompts the user for and accepts values for the item number, name, quantity, and price for each `Invoice`. Then display each completed object. Save the application as **TestInvoice.java**.



### Debugging Exercise

13. Each of the following files saved in the `Chapter.03` folder in your downloadable student files has syntax and/or logic errors. In each case, determine and fix the problem. After you correct the errors, save each file using the same filename preceded with `Fix`. For example, `DebugThree1.java` will become `FixDebugThree1.java`.
  - a. `DebugThree1.java`
  - b. `DebugThree2.java`
  - c. `DebugThree3.java`
  - d. `DebugThree4.java`



When you change a filename, remember to change every instance of the class name within the file so that it matches the new filename. In Java, the filename and class name must always match.



### Game Zone

14. Playing cards are used in many computer games, including versions of such classics as Solitaire, Hearts, and Poker. Design a `Card` class that contains a character data field to hold a suit ('s' for spades, 'h' for hearts, 'd' for diamonds, or 'c' for clubs) and an integer data field for a value from 1 to 13. (When you learn more about string handling in the chapter *Characters, Strings, and the String Builder*, you can modify the class to hold words for the suits, such as "spades" or "hearts," as well as words for some of the values—for example, "ace" or "king".) Include get and set methods for each field. Save the class as **Card.java**.

Write an application that randomly selects two playing cards and displays their values. Simply assign a suit to each of the cards, but generate a random number for each card's value. Appendix D contains information on generating random numbers. To fully understand the process, you must learn more about Java classes and methods. However, for now, you can copy the following statements to generate a random number between 1 and 13 and assign it to a variable:

```
final int CARDS_IN_SUIT = 13;  
myValue = ((int)(Math.random() * 100) % CARDS_IN_SUIT + 1);
```

After reading the chapter *Making Decisions*, you will be able to have the game determine the higher card. For now, just observe how the card values change as you execute the program multiple times. Save the application as **PickTwoCards.java**.



You use the `Math.random()` function to generate a random number. The function call uses only a class and method name—no object—so you know the `random()` method must be a static method.

15. Computer games often contain different characters or creatures. For example, you might design a game in which alien beings possess specific characteristics such as color, number of eyes, or number of lives. Design a character for a game, creating a class to hold at least three attributes for the character. Include methods to get and set each of the character's attributes. Save the file as **MyCharacter.java**. Then write an application in which you create at least two characters. In turn, pass each character to a display method that displays the character's attributes. Save the application as **TwoCharacters.java**.

*This page intentionally left blank*

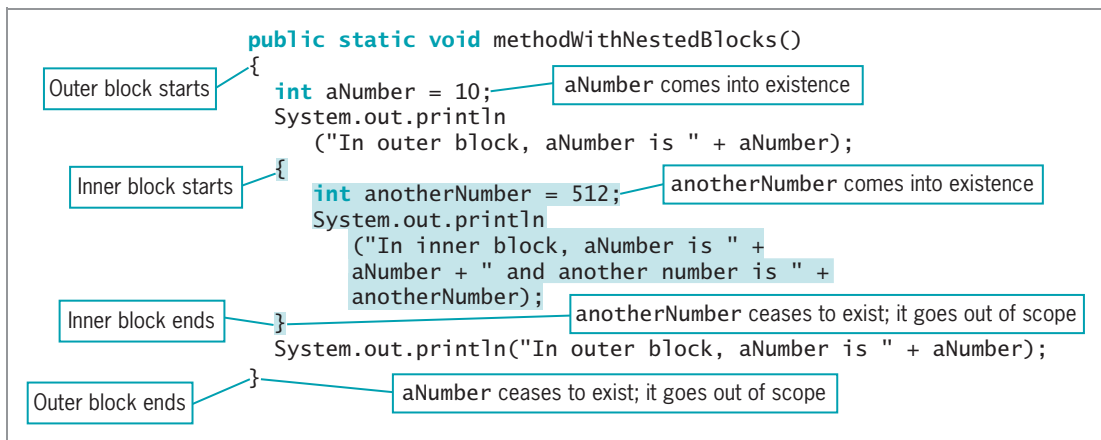
# More Object Concepts

In this chapter, you will:

- ① Understand blocks and scope
- ① Overload a method
- ① Avoid ambiguity
- ① Use constructors with parameters
- ① Use the `this` reference
- ① Use static variables
- ① Use constant fields
- ① Use automatically imported, prewritten constants and methods
- ① Use composition
- ① Use nested and inner classes

## Understanding Blocks and Scope

Within any class or method, the code between a pair of curly braces is called a **block**. For example, the method shown in Figure 4-1 contains two blocks. The first block contains another, so it is an example of an **outside block** (also called an **outer block**). It begins immediately after the method declaration and ends at the end of the method. The second block (shaded in Figure 4-1) is called the **inside block** or **inner block**. It is contained within the second set of curly braces and contains two executable statements: the declaration of `anotherNumber` and a `println()` statement. The inside block is **nested**, or contained entirely within, the outside block. A block can exist entirely within another block or entirely outside and separate from another block, but blocks can never overlap. For example, if a method contains two opening curly braces, indicating the start of two blocks, the next closing curly brace always closes the inner (second) block—it cannot close the outer block because that would make the blocks overlap. Another way to state this concept is that whenever you encounter a closing brace that ends a block, it always closes the most recently started block.



**Figure 4-1** A method with nested blocks

When you declare a variable, you cannot refer to that variable outside its block. As you learned in Chapter 3, the portion of a program within which you can refer to a variable is the variable's scope. A variable comes into existence, or **comes into scope**, when you declare it. A variable ceases to exist, or **goes out of scope**, at the end of the block in which it is declared.



Although you can create as many variables and blocks as you need within any program, it is not wise to do so without a reason. The use of unnecessary variables and blocks increases the likelihood of improper use of variable names and scope.



In the `methodWithNestedBlocks()` method shown in Figure 4-1, the variable `aNumber` exists from the point of its declaration until the end of the method. This means `aNumber` exists both in the outer block and in the inner block and can be used anywhere in the method. The variable `anotherNumber` comes into existence within the inner block; `anotherNumber` goes out of scope when the inner block ends and cannot be used beyond its block. Figure 4-2 shows the output when the method in Figure 4-1 is called from another method.



```
C:\Java>java TestMethodWithNestedBlocks
In outer block, aNumber is 10
In inner block, aNumber is 10 and another number is 512
In outer block, aNumber is 10
C:\Java>
```

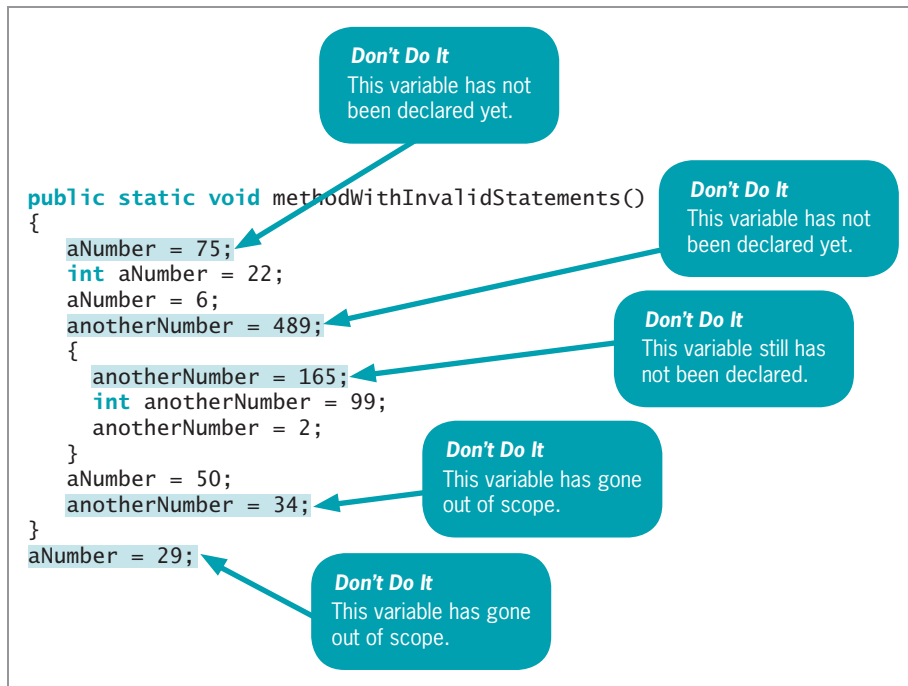
**Figure 4-2** Output produced by application that uses `methodWithNestedBlocks()`



The program that produces the output shown in Figure 4-2 is stored in the `CodeInFigures` folder in your downloadable student files.

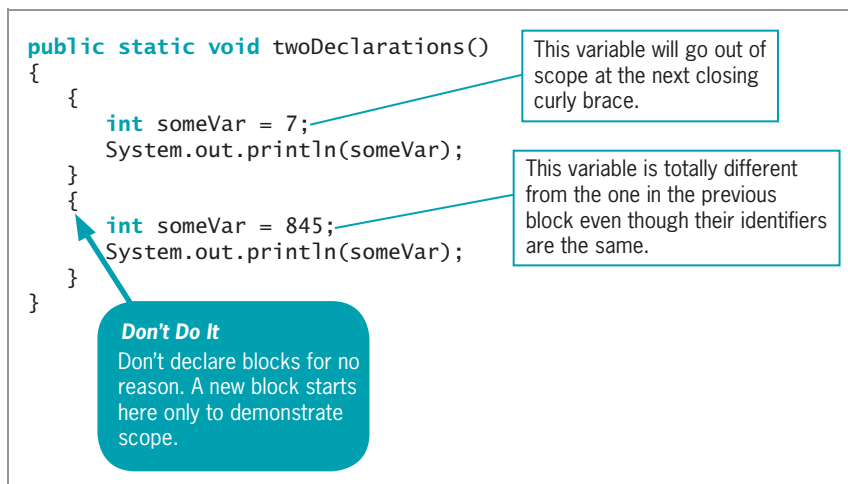
You cannot use a data item that is not in scope. For example, Figure 4-3 shows a method that contains two blocks and some shaded, invalid statements. The opening and closing braces for each block are vertically aligned. You are not required to vertically align the opening and closing braces for a block, but your programs are much easier to read if you do.

The first assignment statement in the first, outer block, `aNumber = 75;`, is invalid because `aNumber` has not been declared yet. Similarly, the statements that attempt to assign 489 and 165 to `anotherNumber` are invalid because `anotherNumber` has not been declared yet. After `anotherNumber` is declared, it can be used for the remainder of the inner block, but the statement that attempts to assign 34 to it is outside the block in which `anotherNumber` was declared. The last shaded statement in Figure 4-3, `aNumber = 29;`, does not work because it falls outside the block in which `aNumber` was declared; it actually falls outside the entire `methodWithInvalidStatements()` method.



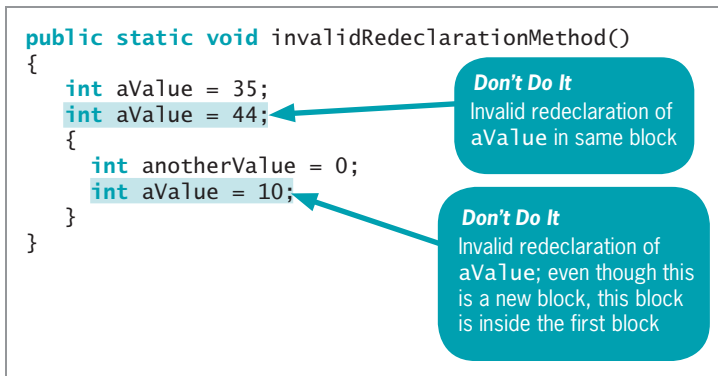
**Figure 4-3** The `methodWithInvalidStatements()` method

Within a method, you can declare a variable with the same name multiple times, as long as each declaration is in its own nonoverlapping block. For example, the two declarations of variables named `someVar` in Figure 4-4 are valid because each variable is contained within its own block. The first instance of `someVar` has gone out of scope before the second instance comes into scope.



**Figure 4-4** The `twoDeclarations()` method

You cannot declare the same variable name more than once within a block, even if a block contains other blocks. When you declare a variable more than once in a block, you are attempting to **redeclare the variable**—an illegal action. For example, in Figure 4-5, the second declaration of `aValue` causes an error because you cannot declare the same variable twice within the outer block of the method. By the same reasoning, the third declaration of `aValue` is also invalid, even though it appears within a new block. The block that contains the third declaration is entirely within the outside block, so the first declaration of `aValue` has not gone out of scope.



**Figure 4-5** The `invalidRedeclarationMethod()`

Although you cannot declare a variable twice within the same block, you can declare a variable within one method of a class and use the same variable name within another method of the class. In this case, the variable declared inside each method resides in its own location in computer memory. When you use the variable's name within the method in which it is declared, it takes precedence over, or **overrides**, any other variable with the same name in another method. In other words, a locally declared variable always masks or hides another variable with the same name elsewhere in the class.

For example, consider the class in Figure 4-6. In the `main()` method of the `OverridingVariable` class, `aNumber` is declared and assigned the value 10. When the program calls `firstMethod()`, a new variable is declared with the same name but with a different memory address and a new value. The new variable exists only within `firstMethod()`, where it is displayed holding the value 77. After `firstMethod()` executes and the logic returns to the `main()` method, the original `aNumber` is displayed, containing 10. When `aNumber` is passed to `secondMethod()`, a copy is made within the method. This copy has the same identifier as the original `aNumber`, but a different memory address. So, within `secondMethod()`, when the value is changed to 862 and displayed, it has no effect on the original variable in `main()`. When the logic returns to `main()` after `secondMethod()`, the original value is displayed again. Examine the output in Figure 4-7 to understand the sequence of events.

```

public class OverridingVariable
{
    public static void main(String[] args)
    {
        int aNumber = 10;
        System.out.println("In main(), aNumber is " + aNumber);
        firstMethod();
        System.out.println("Back in main(), aNumber is " + aNumber);
        secondMethod(aNumber);
        System.out.println("Back in main() again, aNumber is " + aNumber);
    }
    public static void firstMethod()
    {
        int aNumber = 77;
        System.out.println("In firstMethod(), aNumber is "
            + aNumber);
    }
    public static void secondMethod(int aNumber)
    {
        System.out.println("In secondMethod(), at first " +
            "aNumber is " + aNumber);
        aNumber = 862;
        System.out.println("In secondMethod(), after an assignment " +
            "aNumber is " + aNumber);
    }
}

```

aNumber is declared in main().

Whenever aNumber is used in main(), it retains its value of 10.

This aNumber resides at a different memory address than the one in main(). It is declared locally in this method.

This aNumber also resides at a different memory address than the one in main(). It is declared locally in this method.

Figure 4-6 The OverridingVariable class

```

C:\Java>java OverridingVariable
In main(), aNumber is 10
In firstMethod(), aNumber is 77
Back in main(), aNumber is 10
In secondMethod(), at first aNumber is 10
In secondMethod(), after an assignment aNumber is 862
Back in main() again, aNumber is 10

C:\Java>

```

Figure 4-7 Output of the OverridingVariable application



Object-oriented programmers also use the term *override* when a child class contains a field or method that has the same name as one in the parent class. You will learn more about inheritance in the chapters *Introduction to Inheritance* and *Advanced Inheritance Concepts*.



You are familiar with local names overriding names defined elsewhere. If someone in your household is named Eric, and someone in the house next door is named Eric, members of your household who talk about Eric are referring to the local version. They would add a qualifier such as *Eric Johnson* or *Eric next door* to refer to the nonlocal version.



If a local variable or parameter in a method has the same name as a class field, the field is hidden until the block terminates. Java calls this *shadowing*.

When they have the same name, variables within methods of a class override the class's fields. Figure 4-8 shows an `Employee` class that contains two instance variables and three `void` methods. The `setValues()` method provides values for the two class instance fields. Whenever the method named `methodThatUsesInstanceAttributes()` is used with an `Employee` object, the instance values for `empNum` and `empPayRate` are used. However, when the other method, `methodThatUsesLocalVariables()`, is used with an `Employee` object, the local variable values within the method, `33333` and `555.55`, override the class's instance variables. Figure 4-9 shows a short application that declares an `Employee` object and uses each method; Figure 4-10 shows the output.

```

public class Employee
{
    private int empNum;
    private double empPayRate;
    public void setValues()
    {
        empNum = 111;
        empPayRate = 22.22;
    }
    public void methodThatUsesInstanceAttributes()
    {
        System.out.println("Employee number is " + empNum);
        System.out.println("Pay rate is " + empPayRate);
    }
    public void methodThatUsesLocalVariables()
    {
        int empNum = 33333;
        double empPayRate = 555.55;
        System.out.println("Employee number is " + empNum);
        System.out.println("Pay rate is " + empPayRate);
    }
}

```

This method uses the class fields.

This method also uses the class fields.

This method uses the locally declared variables that happen to have the same names as the class fields.

**Figure 4-8** The `Employee` class

```
public class TestEmployeeMethods
{
    public static void main(String[] args)
    {
        Employee aWorker = new Employee();
        aWorker.setValues();
        aWorker.methodThatUsesInstanceAttributes();
        aWorker.methodThatUsesLocalVariables();
    }
}
```

Figure 4-9 The TestEmployeeMethods application



```
ca. Command Prompt
C:\Java>java TestEmployeeMethods
Employee number is 111
Pay rate is 22.22
Employee number is 33333
Pay rate is 555.55
C:\Java>_
```

Figure 4-10 Output of the TestEmployeeMethods application

When you write programs, you might choose to avoid confusing situations that arise when you give the same name to a class's instance field and to a local method variable. But, if you do use the same name, be aware that within the method, the method's local variable overrides the instance variable.



Programmers frequently use the same name for an instance field and a parameter to a method in the same class simply because it is the "best name" to use; in these cases, the programmer must use the `this` reference, which you will learn about later in this chapter.

It is important to understand the impact that blocks and methods have on your variables. Variables and fields with the same names represent different memory locations when they are declared within different scopes. After you understand the scope of variables, you can avoid many potential errors in your programs.

## TWO TRUTHS & A LIE

### Understanding Blocks and Scope

1. A variable ceases to exist, or goes out of scope, at the end of the block in which it is declared.
2. You cannot declare the same variable name more than once within a block, even if a block contains other blocks.
3. A class's instance variables override locally declared variables with the same names that are declared within the class's methods.

The false statement is #3. When they have the same name, variables within methods of a class override a class's instance variables.

165

## Overloading a Method

**Overloading** involves using one term to indicate diverse meanings, or writing multiple methods with the same name but with different parameter lists. When you use the English language, you overload words all the time. When you say “open the door,” “open your eyes,” and “open a computer file,” you are talking about three very different actions using very different methods and producing very different results. However, anyone who speaks English fluently has no trouble understanding your meaning because the verb *open* is understood in the context of the noun that follows it.

When you overload a Java method, you write multiple methods with a shared name. The compiler understands your meaning based on the arguments you use with the method call. For example, suppose you create a class method to apply a simple interest rate to a bank balance. The method is named `calculateInterest()`; it receives two `double` parameters—the balance and the interest rate—and displays the multiplied result. Figure 4-11 shows the method.

```
public static void calculateInterest(double bal, double rate)
{
    double interest;
    interest = bal * rate;
    System.out.println("Simple interest on $" + bal +
        " at " + rate + "% rate is " + interest);
}
```

**Figure 4-11** The `calculateInterest()` method with two `double` parameters



The `calculateInterest()` method in Figure 4-11 can receive integer arguments, even though it is defined as needing `double` arguments, because `ints` are promoted or cast automatically to `doubles`, as you learned in Chapter 2.

166

When an application calls the `calculateInterest()` method and passes two `double` values, as in `calculateInterest(1000.00, 0.04)`, the interest is calculated correctly as 4% of \$1000.00. Assume, however, that different users want to calculate interest using different argument types. Some users who want to indicate an interest rate of 4% might use 0.04; others might use 4 and assume that it means 4%. When the `calculateInterest()` method is called with the arguments \$1000.00 and 0.04, the interest is calculated correctly as 40.00. When the method is called using \$1000.00 and 4, the interest is calculated incorrectly as 4000.00.

A solution for the conflicting use of numbers to represent parameter values is to overload the `calculateInterest()` method. For example, in addition to the `calculateInterest()` method shown in Figure 4-11, you could add the method shown in Figure 4-12.

```
public static void calculateInterest(double bal, int rate)
{
    double interest, rateAsPercent;
    rateAsPercent = rate / 100.0;
    interest = bal * rateAsPercent;
    System.out.println("Simple interest on $" +
        bal + " at " + rate + "% rate is " +
        interest);
}
```

Notice the data type for rate.

Dividing by 100.0 converts rate to its percent equivalent.

**Figure 4-12** The `calculateInterest()` method with a `double` parameter and an `int` parameter



Note the `rateAsPercent` figure is calculated by dividing by 100.0 and not by 100. If two integers are divided, the result is a truncated integer; dividing by a `double` 100.0 causes the result to be a `double`. Alternatively, you could use an explicit cast such as `rateAsPercent = (double)rate / 100`.

If an application calls the method `calculateInterest()` using two `double` arguments—for example, `calculateInterest(1000.00, 0.04)`—the first version of the method, the one shown in Figure 4-11, executes. However, if an integer is used as the second argument in a call to `calculateInterest()`—as in `calculateInterest(1000.00, 4)`—the second version of the method, the one shown in Figure 4-12, executes. In this second example, the whole number rate figure is correctly divided by 100.0 before it is used to determine the interest earned.



Of course, you could use methods with different names to solve the dilemma of producing an accurate interest figure—for example, `calculateInterestUsingDouble()` and `calculateInterestUsingInt()`. However, it is easier and more convenient for programmers who use your methods to remember just one method name they can use in the form that is most appropriate for their programs. It is convenient to be able to use one reasonable name for tasks that are functionally identical except for the argument types that can be passed to them. The compiler knows which method version to call based on the passed arguments.

## TWO TRUTHS & A LIE

### Overloading a Method

1. When you overload Java methods, you write multiple methods with a shared name.
2. When you overload Java methods, the methods are called using different arguments.
3. Instead of overloading methods, it is preferable to write methods with unique identifiers.

The false statement is #3. Overloading methods is preferable to using unique identifiers because it is convenient for programmers to use one reasonable name for tasks that are functionally identical, except for the argument types that can be passed to them.

## Learning About Ambiguity

When an application contains just one version of a method, you can call the method using a parameter of the correct data type or one that can be promoted to the correct data type. For example, consider the simple method shown in Figure 4-13.

```
public static void simpleMethod(double d)
{
    System.out.println("Method receives double parameter");
}
```

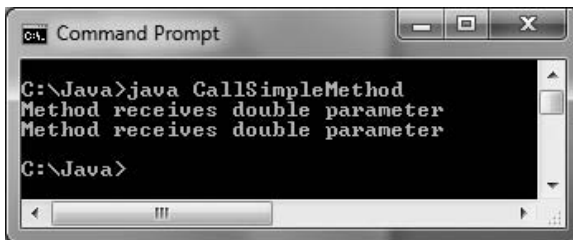
**Figure 4-13** The `simpleMethod()` method with a `double` parameter

If you write an application in which you declare `doubleValue` as a `double` variable and `intValue` as an `int` variable (as shown in Figure 4-14), either of the two method calls `simpleMethod(doubleValue)`; or `simpleMethod(intValue)`; results in the output “Method

receives double parameter”. When you call the method with the integer argument, the integer is cast as (or promoted to) a `double`. The output is shown in Figure 4-15.

```
public class CallSimpleMethod
{
    public static void main(String[] args)
    {
        double doubleValue = 45.67;
        int intValue = 17;
        simpleMethod(doubleValue);
        simpleMethod(intValue);
    }
    public static void simpleMethod(double d)
    {
        System.out.println("Method receives double parameter");
    }
}
```

**Figure 4-14** The `CallSimpleMethod` application that calls `simpleMethod()` with a `double` and an `int`



```
ca. Command Prompt
C:\Java>java CallSimpleMethod
Method receives double parameter
Method receives double parameter
C:\Java>
```

**Figure 4-15** Output of the `CallSimpleMethod` application



Note that if the method with the declaration `void simpleMethod(double d)` did not exist, but the declaration `void simpleMethod(int i)` did exist, then the method call `simpleMethod(doubleValue);` would fail. Although an `int` can be promoted to a `double`, a `double` cannot become an `int`. This makes sense if you consider the potential loss of information when a `double` value is reduced to an integer.

When you properly overload a method, you can call it providing different argument lists, and the appropriate version of the method executes. Within the application in Figure 4-14, if you add a second overloaded `simpleMethod()` method that takes an integer parameter (as shown in Figure 4-16, with the new method shaded), the output changes when you call `simpleMethod(intValue);`. Instead of promoting an integer argument to a `double`, the compiler recognizes a more exact match for the method call that uses the integer argument, so it calls the version of the method that produces the output “Method receives integer parameter”. Figure 4-17 shows the output.

```

public class CallSimpleMethodAgain
{
    public static void main(String[] args)
    {
        double doubleValue = 45.67;
        int intValue = 17;
        simpleMethod(doubleValue);
        simpleMethod(intValue);
    }
    public static void simpleMethod(double d)
    {
        System.out.println("Method receives double parameter");
    }
    public static void simpleMethod(int d)
    {
        System.out.println("Method receives integer parameter");
    }
}

```

**Figure 4-16** The CallSimpleMethodAgain application that calls simpleMethod() with a double and an int



```

C:\Java>java CallSimpleMethodAgain
Method receives double parameter
Method receives integer parameter

C:\Java>

```

**Figure 4-17** Output of the CallSimpleMethodAgain application

When you overload methods, you risk creating an **ambiguous** situation—one in which the compiler cannot determine which method to use. Consider the following overloaded calculateInterest() method declarations:

```

public static void calculateInterest(int bal, double rate)
public static void calculateInterest(double bal, int rate)
    // Notice rate type

```

A call to calculateInterest() with an int and a double argument (in that order) executes the first version of the method, and a call to calculateInterest() with a double and an int argument executes the second version of the method. With each of these calls, the compiler can find an exact match for the arguments you send. However, if you call

`calculateInterest()` using two integer arguments, as in `calculateInterest(300, 6);`, an ambiguous situation arises because there is no exact match for the method call. Because two integers can be promoted to an integer and a `double` (thus matching the first version of the overloaded method), or to a `double` and an integer (thus matching the second version), the compiler does not know which version of the `calculateInterest()` method to use, and the program does not compile.



An overloaded method is not ambiguous on its own—it only becomes ambiguous if you create an ambiguous situation. A program containing a potentially ambiguous situation will run problem-free if you do not make any ambiguous method calls.



In Chapter 2, you learned that Java casts variables to a unifying type when you perform arithmetic with unlike types. In a similar way, Java can promote one data type to another when you pass a parameter to a method. For example, if a method has a `double` parameter and you pass in an integer, it is promoted to a `double`. Recall that the order of promotion is `double`, `float`, `long`, and `int`. Any type in this list can be promoted to any type that precedes it.

It is important to note that you can overload methods correctly by providing different parameter lists for methods with the same name. Methods with identical names that have identical parameter lists but different return types are not overloaded—they are illegal.

For example, the following two methods are illegal in the same class:

```
int aMethod(int x)
void aMethod(int x)
```

The compiler determines which of several versions of a method to call based on the arguments in the method call. If those two methods existed within a class, when the method call `aMethod(17);` was made, the compiler would not know which method to execute because both methods take an integer parameter.



The compiler determines which version of a method to call by the method's signature. In Chapter 3, you learned that a method's signature is the combination of the method name and the number, types, and order of parameters.



If the keyword `final` appears in a method's parameter list, it is ignored when determining ambiguity. In other words, two methods with the headers `void aMethod(int x)` and `void aMethod(final int x)` are ambiguous.



Watch the video *Overloading Methods*.

## TWO TRUTHS & A LIE

### Learning About Ambiguity

1. When it is part of the same program as `void myMethod(int age, String name)`, the following method would be ambiguous: `void myMethod(String name, int age)`.
2. When it is part of the same program as `void myMethod(int age, String name)`, the following method would be ambiguous: `String myMethod(int zipCode, String address)`.
3. When it is part of the same program as `void myMethod(int age, String name)`, the following method would be ambiguous: `void myMethod(int x, String y)`.

The false statement is #1. A method that accepts an `int` parameter followed by a `String` is not ambiguous with one that accepts the parameters in the reverse order.

171

## Using Constructors with Parameters

In Chapter 3, you learned that Java automatically provides a constructor when you create a class. You also learned that you can write your own constructor, and that you often do so when you want to ensure that fields within classes are initialized to some appropriate default value. In Chapter 3, you learned that the automatically provided constructor is a default constructor (one that does not require arguments), and you learned that you can also write a custom default constructor. However, when you write your own constructors, you can also write versions that receive parameters. Such parameters are often used to initialize data fields for an object.

For example, consider the `Employee` class with just one data field, shown in Figure 4-18. Its constructor assigns 999 to the `empNum` of each potentially instantiated `Employee` object. Any time an `Employee` object is created using a statement such as `Employee partTimeWorker = new Employee();`, even if no other data-assigning methods are ever used, you ensure that the `partTimeWorker` `Employee`, like all `Employee` objects, will have an initial `empNum` of 999.

```
public class Employee
{
    private int empNum;
    Employee()
    {
        empNum = 999;
    }
}
```

**Figure 4-18** The `Employee` class with a default constructor that initializes the `empNum` field



You can use a `setEmpNum()` method to assign values to individual `Employee` objects after construction, but a constructor assigns the values at the time of creation.

Alternatively, you might choose to create `Employee` objects with initial `empNum` values that differ for each `Employee`. To accomplish this when the object is instantiated, you can pass an employee number to the constructor. Figure 4-19 shows an `Employee` class that contains a constructor that receives a parameter. With this constructor, an argument is passed using a statement such as the following:

```
Employee partTimeWorker = new Employee(881);
```

When the constructor executes, the integer within the method call is passed to `Employee()` as the parameter `num`, which is assigned to the `empNum` within the constructor.

When you create an `Employee` class with a constructor such as the one shown in Figure 4-19, every `Employee` object you create must have an integer argument in its constructor call. In other words, with this new version of the class, the following statement no longer works:

```
Employee partTimeWorker = new Employee();
```

After you write a constructor for a class, you no longer receive the automatically provided default constructor. If a class's only constructor requires an argument, you must provide an argument for every object of the class that you create.

```
public class Employee
{
    private int empNum;
    Employee(int num)
    {
        empNum = num;
    }
}
```

**Figure 4-19** The `Employee` class with a constructor that accepts a value

## Overloading Constructors

As with any other method, you can overload constructors. Overloading constructors provides you with a way to create objects with different initializing arguments, or none, as needed. For example, in addition to using the provided constructor shown in Figure 4-19, you can create a second constructor for the `Employee` class; Figure 4-20 shows an `Employee` class that contains two constructors. When you use this class to create an `Employee` object, you have the option of creating the object either with or without an initial `empNum` value. When you create an `Employee` object with the statement `Employee aWorker = new Employee();`, the constructor with no parameters is called, and the `Employee` object receives an initial `empNum` value of 999. When you create an `Employee` object with `Employee anotherWorker = new Employee(7677);`, the constructor version that requires an integer is used, and the `anotherWorker` `Employee` receives an initial `empNum` of 7677.

```
public class Employee
{
    private int empNum;
    Employee(int num)
    {
        empNum = num;
    }
    Employee()
    {
        empNum = 999;
    }
}
```

**Figure 4-20** The `Employee` class that contains two constructors



You can use constructor arguments to initialize field values, but you can also use arguments for any other purpose. For example, you could use the presence or absence of an argument simply to determine which of two possible constructors to call, yet not make use of the argument within the constructor. As long as the constructor parameter lists differ, there is no ambiguity about which constructor to call.



Watch the video *Overloading Constructors*.

**TWO TRUTHS & A LIE****Using Constructors with Parameters**

1. A default constructor is one that is automatically created.
2. When you write a constructor, it can be written to receive parameters or not.
3. If a class's only constructor requires an argument, you must provide an argument for every object of the class that you create.

The false statement is #1. A default constructor is one that takes no arguments. The constructor that is automatically created when you do not write your own version is a default constructor, but so is one that you write to take no arguments.

**Learning About the `this` Reference**

When you start creating classes, they can become large very quickly. Besides data fields, each class can have many methods, including several overloaded versions. On paper, a single class might require several pages of coded statements.

When you instantiate an object from a class, memory is reserved for each instance field in the class. For example, if a class contains 20 data fields, when you create one object from that class, enough memory is reserved to hold the 20 values for that object. When you create 200 objects of the same class, the computer reserves enough memory for 4,000 data fields—20 for each of the 200 objects. In many applications, the computer memory requirements can become substantial. Fortunately, it is not necessary to store a separate copy of each variable and method for each instantiation of a class.

Usually, you want each instantiation of a class to have its own data fields. If an `Employee` class contains fields for employee number, name, and salary, every individual `Employee` object needs a unique number, name, and salary value. (When you want each object to have a unique field value, you do not define the field as `static`.) However, when you create a method for a class, any object can use the same method. Whether the method performs a calculation, sets a field value, or constructs an object, the instructions are the same for each instantiated object. Not only would it take an enormous amount of memory to store a separate copy of each method for every object created from a class, but memory would also be wasted because you would be storing identical copies of methods—that is, each object's copy of the method would have the same contents. Luckily, in Java just one copy of each method in a class is stored, and all instantiated objects can use that copy.

When you use a nonstatic method, you use the object name, a dot, and the method name—for example, `aWorker.getEmpNum()` or `anotherWorker.getEmpNum()`. When you execute the `getEmpNum()` method, you are running the only copy of the method. However, within the `getEmpNum()` method, when you access the `empNum` *field*, you access a different field

depending on the object. The compiler must determine *whose* copy of the `empNum` value should be returned by the single `getEmpNum()` method.

The compiler accesses the correct object's field because every time you call a nonstatic method, you implicitly pass a reference to the named object attached to the method call. A **reference** is an object's memory address. The reference is implicit because it is understood automatically without actually being written. The reference to an object that is passed to any object's nonstatic method is called the **this reference**; `this` is a reserved word in Java. For example, the two `getEmpNum()` methods shown in Figure 4-21 perform identically. The first method simply uses the `this` reference without your being aware of it; the second method uses the `this` reference explicitly. Both methods return the `empNum` of the object used to call the method.

```
public int getEmpNum()
{
    return empNum;
}
public int getEmpNum()
{
    return this.empNum;
}
```

The `this` reference is sent into each nonstatic method as a parameter automatically; you do not write code for it.

**Figure 4-21** Two versions of the `getEmpNum()` method, with and without an explicit `this` reference

Frequently, you neither want nor need to refer to the `this` reference within the methods you write, but the `this` reference is always there, working behind the scenes, so that the data field for the correct object can be accessed.



Recall that methods associated with individual objects are instance methods. Only instance methods implicitly receive a `this` reference. In other words, only nonstatic methods receive a `this` reference.

On a few occasions, you must use the `this` reference to make your classes work correctly; one example is shown in the `Student` class in Figure 4-22. Within the constructor for this class, the parameter names `stuNum` and `gpa` are identical to the class field names. Within the constructor, `stuNum` and `gpa` refer to the locally declared names, not the class field names. The statement `stuNum = stuNum` accomplishes nothing—it assigns the local variable value to itself. The client application in Figure 4-23 attempts to create a `Student` object with an ID number of 111 and a grade point average of 3.5, but Figure 4-24 shows the incorrect output. The values are not assigned to the fields; instead, they are just zeroes.



```

public class Student
{
    private int stuNum;
    private double gpa;
    public Student(int stuNum, double gpa)
    {
        stuNum = stuNum;
        gpa = gpa;
    }
    public void showStudent()
    {
        System.out.println("Student #" + stuNum +
            " gpa is " + gpa);
    }
}

```

**Don't Do It**

All four variables used in these two statements are the local versions declared in the method's parameter list. The fields are never accessed and these statements accomplish nothing.

**Figure 4-22** A Student class whose constructor does not work

```

public class TestStudent
{
    public static void main(String[] args)
    {
        Student aPsychMajor =
            new Student(111, 3.5);
        aPsychMajor.showStudent();
    }
}

```

**Figure 4-23** The TestStudent class that instantiates a Student object



```

C:\Java>java TestStudent
Student #0 gpa is 0.0
C:\Java>

```

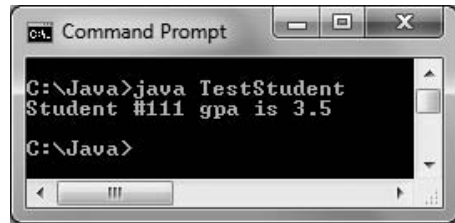
**Figure 4-24** Output of the TestStudent application using the incorrect Student class in Figure 4-22

Figure 4-25 shows a modified Student class. The only difference between this class and the one in Figure 4-22 is the explicit use of the `this` reference within the constructor. When the `this` reference is used with a field name in a class method, the reference is to the class field instead of to the local variable declared within the method. When the TestStudent application uses this new version of the Student class, the output appears as expected, as shown in Figure 4-26.

```

public class Student
{
    private int stuNum;
    private double gpa;
    public Student(int stuNum, double gpa)
    {
        this.stuNum = stuNum;
        this.gpa = gpa;
    }
    public void showStudent()
    {
        System.out.println("Student #" +
            stuNum + " gpa is " + gpa);
    }
}

```



```

C:\Java>java TestStudent
Student #111 gpa is 3.5
C:\Java>

```

**Figure 4-26** Output of the TestStudent application using the new version of the Student class

**Figure 4-25** The Student class using the explicit `this` reference within the constructor

## Using the `this` Reference to Make Overloaded Constructors More Efficient

Suppose you create a student class with data fields for a student number and a grade point average. Further suppose you want four overloaded constructors as follows:

- A constructor that accepts an `int` and a `double` and assigns them the student number and grade point average, respectively
- A constructor that accepts a `double` and assigns it to the grade point average. Every student number is initialized to 999.
- A constructor that accepts an `int` and assigns it to the student number. Every grade point average is initialized to 0.0.
- A default constructor that assigns 999 to every student number and 0.0 to every grade point average

Figure 4-27 shows the class. Although this class works, and allows Students to be constructed in four different ways, there is a lot of repetition within the constructors.

```

public class Student
{
    private int stuNum;
    private double gpa;
    Student(int num, double avg)
    {
        stuNum = num;
        gpa = avg;
    }
}

```

**Figure 4-27** Student class with four constructors (*continues*)

(continued)

```
Student(double avg)
{
    stuNum = 999;
    gpa = avg;
}
Student(int num)
{
    stuNum = num;
    gpa = 0.0;
}
Student()
{
    stuNum = 999;
    gpa = 0.0;
}
}
```

**Figure 4-27** Student class with four constructors

You can make the code in Figure 4-27 more efficient and less error-prone by calling one constructor version from the others. To do so, you use the `this` reference from one constructor version to call another version. Figure 4-28 shows how the `Student` class can be rewritten.

```
public class Student
{
    private int stuNum;
    private double gpa;
    Student(int num, double avg)
    {
        stuNum = num;
        gpa = avg;
    }
    Student(double avg)
    {
        this(999, avg);
    }
    Student(int num)
    {
        this(num, 0.0);
    }
    Student()
    {
        this(999, 0.0);
    }
}
```

**Figure 4-28** The `Student` class using `this` in three of four constructors



Testing a variable to ensure it falls within the proper range of values requires decision making. The next chapter covers this topic.



You cannot call `this()` from other methods in a class; you can only call it from constructors. If you call `this()` from a constructor, it must be the first statement within the constructor.



Watch the video *The this Reference*.

## TWO TRUTHS & A LIE

### Learning About the `this` Reference

1. Usually, you want each instantiation of a class to have its own nonstatic data fields, but each object does not need its own copy of most methods.
2. When you use a nonstatic method, the compiler accesses the correct object's field because you implicitly pass an object reference to the method.
3. The `this` reference is supplied automatically in classes; you cannot use it explicitly.

The false statement is #3. Usually, you neither want nor need to refer to the `this` reference within the methods you write, but you can use it—for example, when there are conflicts between identifiers for fields and local variables.

## Using static Variables

In Chapter 3, you learned that methods you create to use without objects are static. For example, the `main()` method in a program and the methods that `main()` calls without an object reference are static. You also learned that most methods you create within a class from which objects will be instantiated are nonstatic. Static methods do not have a `this` reference because they have no object associated with them; therefore, they are called **class methods**.

You can also create **class variables**, which are variables that are shared by every instantiation of a class. Whereas instance variables in a class exist separately for every object you create, there is only one copy of each **static** class variable per class. For example, consider the `BaseballPlayer` class in Figure 4-29. The `BaseballPlayer` class contains a shaded **static** field named `count`, and two nonstatic fields named `number` and `battingAverage`. The `BaseballPlayer` constructor sets values for `number` and `battingAverage` and increases the `count` by one. In other words, every time a `BaseballPlayer` object is constructed, it contains individual values for `number` and `battingAverage`, and the `count` field contains a count of the number of existing objects and is shared by all `BaseballPlayer` objects.

```
public class BaseballPlayer
{
    private static int count = 0;
    private int number;
    private double battingAverage;
    public BaseballPlayer(int id, double avg)
    {
        number = id;
        battingAverage = avg;
        count = count + 1;
    }
    public void showPlayer()
    {
        System.out.println("Player #" + number +
            " batting average is " + battingAverage +
            " There are " + count + " players");
    }
}
```

**Figure 4-29** The `BaseballPlayer` class

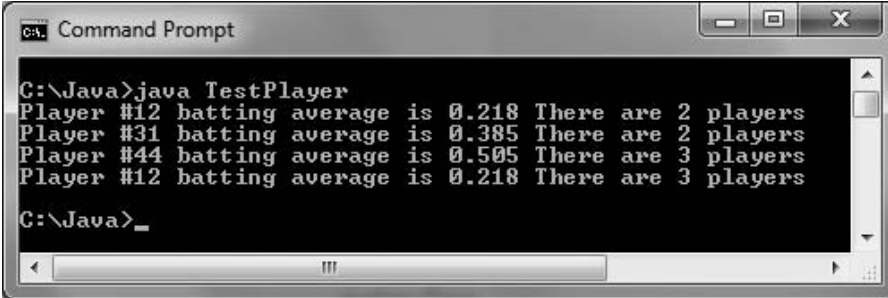
The `TestPlayer` class in Figure 4-30 is an application that declares two `BaseballPlayer` objects, displays them, and then creates a third `BaseballPlayer` object and displays it. When you examine the output in Figure 4-31, you can see that by the time the first two objects are declared, the `count` value that they share is 2. Whether `count` is accessed using the `aCatcher` object or the `aShortstop` object, the `count` is the same. After the third object is declared, its `count` value is 3, as is the value of `count` associated with the previously declared `aCatcher` object. In other words, because the static `count` variable is incremented within the class constructor, each object has access to the total number of objects that currently exist. No matter how many `BaseballPlayer` objects are eventually instantiated, each refers to the single `count` field.



Methods declared as `static` cannot access instance variables, but instance methods can access both `static` and instance variables.

```
public class TestPlayer
{
    public static void main(String[] args)
    {
        BaseballPlayer aCatcher = new BaseballPlayer(12, .218);
        BaseballPlayer aShortstop = new BaseballPlayer(31, .385);
        aCatcher.showPlayer();
        aShortstop.showPlayer();
        BaseballPlayer anOutfielder = new BaseballPlayer(44, .505);
        anOutfielder.showPlayer();
        aCatcher.showPlayer();
    }
}
```

Figure 4-30 The TestPlayer class



```
ca. Command Prompt
C:\Java>java TestPlayer
Player #12 batting average is 0.218 There are 2 players
Player #31 batting average is 0.385 There are 2 players
Player #44 batting average is 0.505 There are 3 players
Player #12 batting average is 0.218 There are 3 players
C:\Java>_
```

Figure 4-31 Output of the TestPlayer application

## TWO TRUTHS & A LIE

### Using static Variables

1. Methods declared as `static` receive a `this` reference that contains a reference to the object associated with them.
2. Methods declared as `static` are called class methods.
3. Class variables are variables that are shared by every instantiation of a class.

The false statement is #1. Static methods do not have a `this` reference because they have no object associated with them.

## Using Constant Fields

In Chapter 2, you learned to create named constants by using the keyword `final`. Sometimes a data field in a class should be constant. For example, you might want to store a school ID value that is the same for every `Student` object you create, so you declare it to be static. In addition, if you want the value for the school ID to be fixed so that all `Student` objects use the same ID value—for example, when applying to scholarship-granting organizations or when registering for standardized tests—you might want to make the school ID unalterable. As with ordinary variables, you use the keyword `final` with a field to make its value unalterable after construction. For example, the class in Figure 4-32 contains the symbolic constant `SCHOOL_ID`. Because it is static, all objects share a single memory location for the field, and because it is `final`, it cannot change during program execution.

```
public class Student
{
    private static final int SCHOOL_ID = 12345;
    private int stuNum;
    private double gpa;
    public Student(int stuNum, double gpa)
    {
        this.stuNum = stuNum;
        this.gpa = gpa;
    }
    public void showStudent()
    {
        System.out.println("Student #" + stuNum +
            " gpa is " + gpa);
    }
}
```

**Figure 4-32** The `Student` class containing a symbolic constant

A nonstatic `final` field's value can be set in the class constructor. For example, you can set it using a constant, or you can set it using a parameter passed into the constructor. However, after construction, you cannot change a `final` field's value.



You can use the keyword `final` with methods or classes. When used in this manner, `final` indicates limitations placed on inheritance. You will learn more about inheritance in the chapters *Introduction to Inheritance* and *Advanced Inheritance Concepts*.



Fields that are `final` also can be initialized in a `static` initialization block. For more details about this technique, see <http://java.sun.com>.



Fields declared to be `static` are not always `final`. If you want to create a field that all members of the class can access, but the field value changes, then it is `static` but not `final`. Similarly, `final` fields are not always `static`. If you want each object created from a class to contain its own final value (perhaps using a parameter to its constructor), you would not declare the field to be `static`.

## TWO TRUTHS & A LIE

### Using Constant Fields

1. A `static` field's value is shared by every object of that class.
2. A `final` field's value is shared by every object of a class.
3. A `final static` field's value is shared by every object of a class.

The false statement is #2. A `final` field's value can be assigned only once, but it is not shared by every object unless it is also `static`.

## Using Automatically Imported, Prewritten Constants and Methods

Often you will need to create classes from which you will instantiate objects. You can create an `Employee` class with fields appropriate for describing employees in your organization and their functions, and an `Inventory` class with fields appropriate for whatever type of item you manufacture. However, many classes are commonly used by a wide variety of programmers. Rather than have each Java programmer “reinvent the wheel,” the creators of Java have produced hundreds of classes for you to use in your programs.

You have already used several of these prewritten classes; for example, you have used the `System` and `JOptionPane` classes to produce output. Each of these classes is stored in a **package**, or a **library of classes**, which is simply a folder that provides a convenient grouping for classes. Many Java packages are available only if you explicitly name them within your program; for example, when you use `JOptionPane`, you must import the `javax.swing` package into your program. However, the group that contains classes such as `System` is used so frequently that it is available automatically to every program you write. The package that is implicitly imported into every Java program is named **java.lang**. The classes it contains are **fundamental classes**, or basic classes, as opposed to the **optional classes** that must be explicitly named. Some references list a few other Java classes as also being “fundamental,” but the `java.lang` package is the only automatically imported, named package.



The class `java.lang.Math` contains constants and methods that you can use to perform common mathematical functions. All of the constants and methods in the `Math` class are `static`—they are class variables and class methods. For example, a commonly used constant is `PI`. In geometry,  $\pi$  is an approximation of a circle's radius based on the ratio of the circumference of the circle to its diameter. Within the `Math` class, the declaration for `PI` is as follows:

```
public final static double PI = 3.14159265358979323846;
```

Notice that `PI` is:

- `public`, so any program can access it directly
- `final`, so it cannot be changed
- `static`, so only one copy exists and you can access it without declaring a `Math` object
- `double`, so it holds a floating-point value



For mathematicians, another useful constant is `E`, which represents the base of natural logarithms. Its definition is as follows:

```
public final static double E = 2.7182818284590452354;
```

You can use the value of `PI` within any program you write by referencing the full package path in which `PI` is defined; for example, you can calculate the area of a circle using the following statement:

```
areaOfCircle = java.lang.Math.PI * radius * radius;
```

However, the `java.lang` package is imported automatically into your programs, so if you simply reference `Math.PI`, Java recognizes this code as a shortcut to the full package path. Therefore, the preferred (and simpler) statement is the following:

```
areaOfCircle = Math.PI * radius * radius;
```

In addition to constants, many useful methods are available within the `Math` class. For example, the `Math.max()` method returns the larger of two values, and the method `Math.abs()` returns the absolute value of a number. Table 4-1 lists some common `Math` class methods.

| Method               | Value That the Method Returns |
|----------------------|-------------------------------|
| <code>abs(x)</code>  | Absolute value of $x$         |
| <code>acos(x)</code> | Arc cosine of $x$             |
| <code>asin(x)</code> | Arc sine of $x$               |
| <code>atan(x)</code> | Arc tangent of $x$            |

**Table 4-1** Common `Math` class methods (*continues*)

*(continued)*

| Method                   | Value That the Method Returns                                                                                                                     |
|--------------------------|---------------------------------------------------------------------------------------------------------------------------------------------------|
| <code>atan2(x, y)</code> | Theta component of the polar coordinate (r, theta) that corresponds to the Cartesian coordinate x, y                                              |
| <code>ceil(x)</code>     | Smallest integral value not less than x (ceiling)                                                                                                 |
| <code>cos(x)</code>      | Cosine of x                                                                                                                                       |
| <code>exp(x)</code>      | Exponent, where x is the base of the natural logarithms                                                                                           |
| <code>floor(x)</code>    | Largest integral value not greater than x                                                                                                         |
| <code>log(x)</code>      | Natural logarithm of x                                                                                                                            |
| <code>max(x, y)</code>   | Larger of x and y                                                                                                                                 |
| <code>min(x, y)</code>   | Smaller of x and y                                                                                                                                |
| <code>pow(x, y)</code>   | x raised to the y power                                                                                                                           |
| <code>random()</code>    | Random <code>double</code> number between 0.0 and 1.0                                                                                             |
| <code>rint(x)</code>     | Closest integer to x (x is a <code>double</code> , and the return value is expressed as a <code>double</code> )                                   |
| <code>round(x)</code>    | Closest integer to x (where x is a <code>float</code> or <code>double</code> , and the return value is an <code>int</code> or <code>long</code> ) |
| <code>sin(x)</code>      | Sine of x                                                                                                                                         |
| <code>sqrt(x)</code>     | Square root of x                                                                                                                                  |
| <code>tan(x)</code>      | Tangent of x                                                                                                                                      |

**Table 4-1** Common Math class methods

Because all constants and methods in the `Math` class are classwide (that is, `static`), there is no need to create an instance of the `Math` class. You cannot instantiate objects of type `Math` because the constructor for the `Math` class is `private`, and your programs cannot access the constructor.



Unless you are a mathematician, you won't use many of these `Math` class methods, and it is unwise to do so unless you understand their purposes. For example, because the square root of a negative number is undefined, if you display the result after the method call `imaginaryNumber = Math.sqrt(-12);`, you see `NaN`. **NaN** stands for "Not a Number."

## Using the `GregorianCalendar` Class

Java includes a `GregorianCalendar` class that is useful when working with dates and time. The Gregorian calendar is used in most of the world; it was instituted on October 15, 1582,

and is named for Pope Gregory XIII, who was instrumental in the calendar's adoption. (For dates that fall before the Gregorian cutover date, the `GregorianCalendar` class uses the Julian calendar, which simply uses a different leap-year rule.)

Java contains hundreds of classes, only a few of which—those in the `java.lang` package—are included automatically in the programs you write. To use any of the other predefined classes, you must use one of three methods:

- Use the entire path with the class name.
- Import the class.
- Import the package that contains the class you are using.

You have seen examples in this book in which the `JOptionPane` and `Scanner` classes were imported so you could use their methods. Similarly, you can import the `java.util` class package, which includes the `GregorianCalendar` class.

You can instantiate an object of type `GregorianCalendar` from this class by using the full class path, as in the following:

```
java.util.GregorianCalendar myAnniversary = new java.util.GregorianCalendar();
```

Alternatively, when you include `import java.util.GregorianCalendar;` as the first line in your program, you can shorten the declaration of `myAnniversary` to this:

```
GregorianCalendar myAnniversary = new GregorianCalendar();
```

An alternative to importing a class is to import an entire package of classes. You can use the asterisk (`*`) as a **wildcard symbol**, which indicates that it can be replaced by any set of characters. In a Java `import` statement, you use a wildcard symbol to represent all the classes in a package. Therefore, the following statement imports the `GregorianCalendar` class and any other `java.util` classes as well:

```
import java.util.*;
```

There is no disadvantage to importing the extra classes, and you will most commonly see the wildcard method in professionally written Java programs. However, you have the alternative of importing each class you need individually. Importing each class by name, without wildcards, can be a form of documentation; this technique specifically shows which parts of the package are being used.



You cannot use the Java-language wildcard exactly like a DOS or UNIX wildcard because you cannot import all the Java classes with `import java.*;`. The Java wildcard works only with specific packages such as `import java.util.*;` or `import java.lang.*;`. Also, note that the asterisk in an `import` statement imports all of the classes in a package, but not other packages that are within the imported package.



The `import` statement does not move the entire imported class or package into your program, as its name implies. Rather, it simply notifies the program that you will be using the data and method names that are part of the imported class or package.



Your own classes are included in applications without `import` statements because of your `classpath` settings. See Appendix A for more information on `classpath`.

Seven constructors are available for `GregorianCalendar` objects. These constructors are overloaded, requiring different argument lists when they are called. The default constructor for the `GregorianCalendar` class creates a calendar object containing the current date and time in the default locale (time zone) that has been set for your computer. You can use other constructors to specify:

- year, month, date
- year, month, date, hour, minute
- year, month, date, hour, minute, second
- `Locale`
- `TimeZone`
- `TimeZone`, `Locale`

You can create a default `GregorianCalendar` object with a statement such as the following:

```
GregorianCalendar today = new GregorianCalendar();
```

Alternatively, you can create a `GregorianCalendar` object using one of the overloaded constructors—for example:

```
GregorianCalendar myGraduationDate = new  
GregorianCalendar(2012, 5, 24);
```



As you read this discussion of the `GregorianCalendar` class, go to <http://java.sun.com>, select API Specifications, select the version of Java you are using, and choose `GregorianCalendar` from the list of available classes. The online Java documentation provides valuable information about the data fields and methods that are available with every built-in class. For example, `TimeZone` and `Locale` are classes that are available to control date and time information. This section discusses the `GregorianCalendar` class as an example of an interesting class, but you can apply what you learn here to any Java class; the techniques for importing and using any class are the same.

Specific data field values, such as the day, month, and year, can be retrieved from a `GregorianCalendar` object by using a class `get()` method and specifying what you want as an argument. You could retrieve the day of the year (for example, February 1 is the 32nd day of the year) with the following statement:

```
int dayOfYear = today.get(GregorianCalendar.DAY_OF_YEAR);
```

The `GregorianCalendar` `get()` method always returns an integer. Some of the possible arguments to the `get()` method are shown in Table 4-2. In particular, notice that the month values in the `GregorianCalendar` class range from 0 through 11. Thus, January is month 0, February is month 1, and so on.

| Arguments    | Values Returned by get()                                              |
|--------------|-----------------------------------------------------------------------|
| DAY_OF_YEAR  | A value from 1 to 366                                                 |
| DAY_OF_MONTH | A value from 1 to 31                                                  |
| DAY_OF_WEEK  | SUNDAY, MONDAY, ... SATURDAY, corresponding to values from 1 to 7     |
| YEAR         | The current year; for example, 2012                                   |
| MONTH        | JANUARY, FEBRUARY, ... DECEMBER, corresponding to values from 0 to 11 |
| HOUR         | A value from 1 to 12; the current hour in the A.M. or P.M.            |
| AM_PM        | A.M. or P.M., which correspond to values from 0 to 1                  |
| HOUR_OF_DAY  | A value from 0 to 23 based on a 24-hour clock                         |
| MINUTE       | The minute in the hour, a value from 0 to 59                          |
| SECOND       | The second in the minute, a value from 0 to 59                        |
| MILLISECOND  | The millisecond in the second, a value from 0 to 999                  |

**Table 4-2** Some possible arguments to and returns from the `GregorianCalendar` `get()` method

As an example of how to use a `GregorianCalendar` object, Figure 4-33 shows an `AgeCalculator` application. In this class, a default `GregorianCalendar` object named `now` is created. The user is prompted for a birth year, the current year is extracted from the `now` object using the `get()` method, and the user's age this year is calculated by subtracting the birth year from the current year. Figure 4-34 shows the output when a user born in 1984 runs the application in 2012.

```
import java.util.*;
import javax.swing.*;
public class AgeCalculator
{
    public static void main(String[] args)
    {
        GregorianCalendar now = new GregorianCalendar();
        int nowYear;
        int birthYear;
        int yearsOld;
        birthYear = Integer.parseInt
            (JOptionPane.showInputDialog(null,
                "In what year were you born?"));
        nowYear = now.get(GregorianCalendar.YEAR);
        yearsOld = nowYear - birthYear;
    }
}
```

**Figure 4-33** The `AgeCalculator` application (*continues*)

(continued)

```
JOptionPane.showMessageDialog(null,
    "This is the year you become " + yearsOld +
    " years old");
}
```

**Figure 4-33** The AgeCalculator application



The `parseInt()` method is used in the application in Figure 4-33 to convert the user's input string to an integer. You learned about the `parseInt()` method in Chapter 2.



**Figure 4-34** Execution of the AgeCalculator application

## TWO TRUTHS & A LIE

### Using Automatically Imported, Prewritten Constants and Methods

1. The creators of Java have produced hundreds of classes for you to use in your programs.
2. Java packages are available only if you explicitly name them within your program.
3. The implicitly imported `java.lang` package contains fundamental Java classes.

The false statement is #2. Many Java packages are available only if you explicitly name them within your program, but others are automatically imported.

## Understanding Composition

The fields in a class can be simple data types like `int` and `double`, but they can also be class types. **Composition** describes the relationship between classes when an object of one class is a data field within another class. When you use an object as a data member of another object, you must remember to supply values for the contained object if it has no default constructor.



You have already studied many classes that contain `String` object fields. These classes employ composition.

For example, you might create a class named `NameAndAddress` that stores name and address information. Such a class could be used for employees, customers, students, or anyone else who has a name and address. Figure 4-35 shows a `NameAndAddress` class. The class contains three fields, all of which are set by the constructor. A `display()` method displays the name and address information on three lines.

```
public class NameAndAddress
{
    private String name;
    private String address;
    private int zipCode;
    public NameAndAddress(String nm, String add, int zip)
    {
        name = nm;
        address = add;
        zipCode = zip;
    }
    public void display()
    {
        System.out.println(name);
        System.out.println(address);
        System.out.println(zipCode);
    }
}
```

**Figure 4-35** The `NameAndAddress` class

Suppose you want to create a `School` class that holds information about a school. Instead of declaring fields for the `School`'s name and address, you could use the `NameAndAddress` class. The relationship created is sometimes called a **has-a relationship** because one class “has an” instance of another. Figure 4-36 shows a `School` class in which the shaded data member is a `NameAndAddress` object.

```

public class School
{
    private NameAndAddress nameAdd;
    private int enrollment;
    public School(String name, String add, int zip, int enrolled)
    {
        nameAdd = new NameAndAddress(name, add, zip);
        enrollment = enrolled;
    }
    public void display()
    {
        System.out.println("The school information:");
        nameAdd.display();
        System.out.println("Enrollment is " + enrollment);
    }
}

```

This statement calls the `display()` method in the `NameAndAddress` class in Figure 4-35.

Figure 4-36 The `School` class



If the `NameAndAddress` class contained a default constructor, then you could use the following statement within the `School` constructor:

```
nameAdd = new NameAndAddress();
```

As Figure 4-36 shows, the `School` constructor requires four pieces of data. Within the constructor, three of the items—the name, address, and zip code—are passed to the `NameAndAddress` constructor to provide values for the appropriate fields. The fourth constructor parameter (the school's enrollment) is a standard, simple parameter that is assigned to the `School` class enrollment field.

In the `School` class `display` method, the `NameAndAddress` object's `display()` method is called to display the school's name and address. The enrollment value is displayed afterward. Figure 4-37 shows a simple program that instantiates one `School` object. Figure 4-38 shows the execution.

```

public class SchoolDemo
{
    public static void main(String[] args)
    {
        School mySchool = new School
            ("Audubon Elementary",
            "3500 Hoyne", 60618, 350);
        mySchool.display();
    }
}

```

```

C:\Java>java SchoolDemo
The school information:
Audubon Elementary
3500 Hoyne
60618
Enrollment is 350
C:\Java>

```

Figure 4-37 The `SchoolDemo` program

Figure 4-38 Output of the `SchoolDemo` program



## TWO TRUTHS & A LIE

### Understanding Composition

1. Exposition describes the relationship between classes when an object of one class is a data field within another class.
2. When you use an object as a data member of another object, you must remember to supply values for the contained object if it has no default constructor.
3. A has-a relationship exists when a class contains data members that are objects.

The false statement is #1. Composition describes the relationship between classes when an object of one class is a data field within another class.

191

## A Brief Look at Nested and Inner Classes

Every class you have studied so far has been stored in its own file, and the filename has always matched the class name. In Java, you can create a class within another class and store them together; such classes are **nested classes**. The containing class is the **top-level class**. There are four types of nested classes:

- **static member classes:** A static member class has access to all static methods of the top-level class.
- **Nonstatic member classes**, also known as **inner classes:** This type of class requires an instance; it has access to all data and methods of the top-level class.
- **Local classes:** These are local to a block of code.
- **Anonymous classes:** These are local classes that have no identifier.

The most common reason to nest a class inside another is because the inner class is used only by the top-level class; in other words, it is a “helper class” to the top-level class. Being able to package the classes together makes their connection easier to understand and their code easier to maintain.

For example, consider a `RealEstateListing` class used by a real estate company to describe houses that are available for sale. The class might contain separate fields for a listing number, the price, the street address, and the house’s living area. As an alternative, you might decide that although the listing number and price “go with” the real estate listing, the street address and living area really “go with” the house. So you might create an inner class like the one in Figure 4-39.

```
public class RealEstateListing
{
    private int listingNumber;
    private double price;
    private HouseData houseData;
    public RealEstateListing(int num, double price, String address,
        int sqFt)
    {
        listingNumber = num;
        this.price = price;
        houseData = new HouseData(address, sqFt);
    }
    public void display()
    {
        System.out.println("Listing number #" + listingNumber +
            " Selling for $" + price);
        System.out.println("Address: " + houseData.streetAddress);
        System.out.println(houseData.squareFeet + " square feet");
    }
    private class HouseData
    {
        private String streetAddress;
        private int squareFeet;
        public HouseData(String address, int sqFt)
        {
            streetAddress = address;
            squareFeet = sqFt;
        }
    }
}
```

**Figure 4-39** The RealEstateListing class



Notice that the inner class in Figure 4-39 is a `private` class. You don't have to make an inner class `private`, but doing so keeps its members hidden from outside classes. If you wanted a class's members to be accessible, you would not make it an inner class. An inner class can access its top-level class's fields and methods, even if they are `private`, and an outer class can access its inner class's members.

You usually will not want to create inner classes. For example, if you made the `HouseData` class a regular class (as opposed to an inner class) and stored it in its own file, you could use it with composition in other classes—perhaps a `MortgageLoan` class or an `Appraisal` class. As it stands, it is usable only in the class in which it now resides. You probably will not create nested classes frequently, but you will see them implemented in some built-in Java classes.

## TWO TRUTHS & A LIE

### A Brief Look at Nested and Inner Classes

1. A nested class resides within another class.
2. Nonstatic member classes are known as inner classes.
3. The most common reason to nest a class inside another is to save space by combining similar classes in a single file.

The false statement is #3. The most common reason to nest a class inside another is because the inner class is used only by the top-level class as a helper class, and making it a nested class helps organization.

193

## You Do It

### Demonstrating Scope

In this section, you will create a method with several blocks to demonstrate block scope.

#### To demonstrate block scope:

1. Start your text editor, and then open a new document, if necessary.
2. Type the first few lines for a class named DemoBlock:
 

```
public class DemoBlock
{
    public static void main(String[] args)
```
3. Add a statement that displays the purpose of the program:
 

```
System.out.println("Demonstrating block scope");
```
4. On a new line, declare an integer named x, assign the value 1111 to it, and display its value:
 

```
int x = 1111;
System.out.println("In first block x is " + x);
```
5. Begin a new block by typing an opening curly brace on the next line. Within the new block, declare another integer named y, and display x and y. The value of x will be 1111 and the value of y will be 2222:
 

```
{
    int y = 2222;
    System.out.println("In second block x is " + x);
    System.out.println("In second block y is " + y);
}
```
6. On the next line, begin another new block. Within this new block, declare a new integer with the same name as the integer declared in the previous block; then display x and y.

The value of `y` will be 3333. Call a method named `demoMethod()`, and display `x` and `y` again. Even though you will include statements within `demoMethod()` that assign different values to `x` and `y`, the `x` and `y` displayed here will still be 1111 and 3333:

```
{
    int y = 3333;
    System.out.println("In third block x is " + x);
    System.out.println("In third block y is " + y);
    demoMethod();
    System.out.println("After method x is " + x);
    System.out.println("After method block y is " + y);
}
```

7. On a new line after the end of the block, type the following:

```
System.out.println("At the end x is " + x);
```

This last statement in the `main()` method displays the value of `x`, which is still 1111. Type a closing curly brace.

8. Finally, enter the following `demoMethod()` that creates its own `x` and `y` variables, assigns different values, and then displays them:

```
public static void demoMethod()
{
    int x = 8888, y = 9999;
    System.out.println("In demoMethod x is " + x);
    System.out.println("In demoMethod block y is " + y);
}
```

9. Type the final closing curly brace, and then save the file as **DemoBlock.java**. At the command prompt, compile the file by typing the command **javac DemoBlock.java**. If necessary, correct any errors and compile again.

10. Run the program by typing the command **java DemoBlock**. Your output should look like Figure 4-40. Make certain you understand how the values of `x` and `y` are determined in each line of output.

```
C:\Java>java DemoBlock
Demonstrating block scope
In first block x is 1111
In second block x is 1111
In second block y is 2222
In third block x is 1111
In third block y is 3333
In demoMethod x is 8888
In demoMethod block y is 9999
After method x is 1111
After method block y is 3333
At the end x is 1111
C:\Java>
```

Figure 4-40 Output of the `DemoBlock` application

11. To gain a more complete understanding of blocks and scope, change the values of `x` and `y` in several locations throughout the program, and try to predict the exact output before resaving, recompiling, and rerunning the program.

## Overloading Methods

Next, you will overload methods to display dates. The date-displaying methods might be used by many different applications in an organization, such as those that schedule jobs, appointments, employee reviews, and so on. The methods take one, two, or three integer arguments. If there is one argument, it is the month, and the date becomes the first day of the given month in the year 2013. If there are two arguments, they are the month and the day in the year 2013. Three arguments represent the month, day, and year.



Instead of creating your own class to store dates, you can use the built-in Java class `GregorianCalendar` to handle dates. This exercise illustrates how some of the built-in `GregorianCalendar` class was constructed by Java's creators.

### To create an application that calls a `displayDate()` method that can take one, two, or three arguments:

1. Open a new file in your text editor.
2. Begin the following `DemoOverload` class with three integer variables to test the method and three calls to a `displayDate()` method:

```
public class DemoOverload
{
    public static void main(String[] args)
    {
        int month = 6, day = 24, year = 2012;
        displayDate(month);
        displayDate(month, day);
        displayDate(month, day, year);
    }
}
```

3. Create the following `displayDate()` method that requires one parameter to represent the month and uses default values for the day and year:

```
public static void displayDate(int mm)
{
    System.out.println("Event date " + mm + "/1/2013");
}
```

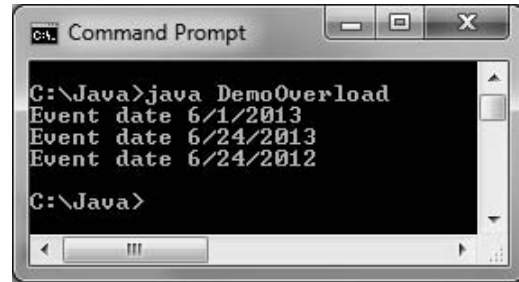
4. Create the following `displayDate()` method that requires two parameters to represent the month and day and uses a default value for the year:

```
public static void displayDate(int mm, int dd)
{
    System.out.println("Event date " + mm + "/" + dd + "/2013");
}
```

5. Create the following `displayDate()` method that requires three parameters used as the month, day, and year:

```
public static void displayDate(int mm, int dd, int yy)
{
    System.out.println("Event date " + mm + "/" + dd + "/" + yy);
}
```

6. Type the closing curly brace for the `DemoOverload` class.
7. Save the file as **DemoOverload.java**.
8. Compile the program, correct any errors, recompile if necessary, and then execute the program. Figure 4-41 shows the output. Notice that whether you call the `displayDate()` method using one, two, or three arguments, the date is displayed correctly because you have successfully overloaded the `displayDate()` method.



```
C:\Java>java DemoOverload
Event date 6/1/2013
Event date 6/24/2013
Event date 6/24/2012
C:\Java>
```

**Figure 4-41** Output of the `DemoOverload` application

## Creating Overloaded Constructors

In this section, you will create a class with overloaded constructors and demonstrate how they work.

### To create a `CarInsurancePolicy` class with overloaded constructors:

1. Open a new file in your text editor, and start the `CarInsurancePolicy` class as follows. The class contains three fields that hold a policy number, the number of payments the policy holder will make annually, and the policy holder's city of residence.

```
public class CarInsurancePolicy
{
    private int policyNumber;
    private int numPayments;
    private String residentCity;
```

2. Create a constructor that requires parameters for all three data fields.

```
public CarInsurancePolicy(int num, int payments, String city)
{
    policyNumber = num;
    numPayments = payments;
    residentCity = city;
}
```

3. Suppose the agency that sells car insurance policies is in the city of Mayfield. Create a two-parameter constructor that requires only a policy number and number of payments. This constructor sends the two parameters and *Mayfield* to the three-parameter constructor.

```
public CarInsurancePolicy(int num, int payments)
{
    this(num, payments, "Mayfield");
}
```

4. Add a third constructor that requires only a policy number parameter. This constructor passes the policy number and a default value of two annual payments to the two-parameter instructor. There, those values and *Mayfield* will be passed to the three-parameter constructor.

```
public CarInsurancePolicy(int num)
{
    this(num, 2);
}
```

5. Add a `display()` method that outputs all the insurance policy data:

```
public void display()
{
    System.out.println("Policy #" + policyNumber + ". " +
        numPayments + " payments annually. Driver resides in " +
        residentCity + ".");
}
```

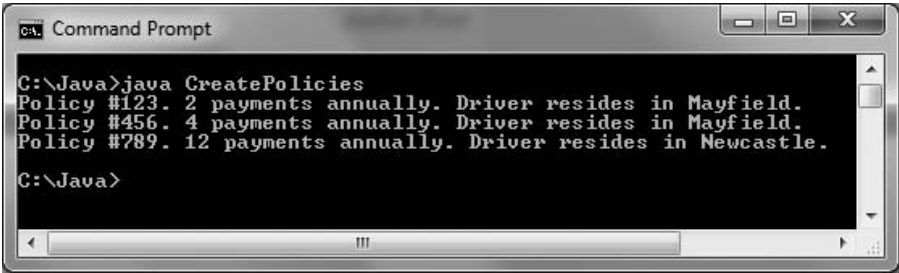
6. Add a closing curly brace for the class. Save the file as **CarInsurancePolicy.java**.
7. Open a new text file to create a short application that demonstrates the constructors at work. The application declares three `CarInsurancePolicy` objects using a different constructor version each time. Type the following code:

```
public class CreatePolicies
{
    public static void main(String[] args)
    {
        CarInsurancePolicy first = new CarInsurancePolicy(123);
        CarInsurancePolicy second = new CarInsurancePolicy(456, 4);
        CarInsurancePolicy third = new CarInsurancePolicy
            (789, 12, "Newcastle");
    }
}
```

8. Next, display each object, and add closing curly braces for the method and the class:

```
    first.display();
    second.display();
    third.display();
}
```

9. Save the file as **CreatePolicies.java**, and then compile and test the program. The output appears in Figure 4-42.



```

C:\Java>java CreatePolicies
Policy #123. 2 payments annually. Driver resides in Mayfield.
Policy #456. 4 payments annually. Driver resides in Mayfield.
Policy #789. 12 payments annually. Driver resides in Newcastle.
C:\Java>
```

**Figure 4-42** Output of the `CreatePolicies` program

10. Add a fourth declaration to the `CreatePolicies` class that attempts to create a `CarInsurancePolicy` object using a default constructor:

```
CarInsurancePolicy fourth = new CarInsurancePolicy();
```

11. Save and compile the revised `CreatePolicies` program. The class does not compile because the `CarInsurancePolicy` class does not contain a default constructor. Change the newly added declaration to a comment, compile the class again, and observe that the class now compiles correctly.

## Using an Explicitly Imported Prewritten Class

Next, you will construct a program using the `GregorianCalendar` class and some of the arguments to the `GregorianCalendar` `get()` method.

### To write a program that uses the `GregorianCalendar` class:

1. Open a new file in your text editor. For the first line in the file, type the following:  
`import java.util.*;`
2. On the next lines, begin the class by typing the class header, the opening brace, the `main()` method header, and its opening brace, as follows:

```
public class CalendarDemo
{
    public static void main(String[] args)
    {
```

3. Declare a `GregorianCalendar` object named `now` that holds information about the current date and time. Then create a series of output statements that display a variety of `GregorianCalendar` fields containing information about the date:

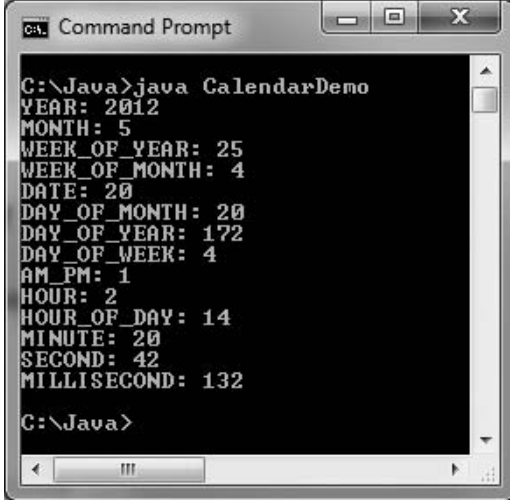
```
GregorianCalendar now = new GregorianCalendar();
System.out.println("YEAR: " + now.get(Calendar.YEAR));
System.out.println("MONTH: " + now.get(Calendar.MONTH));
System.out.println("WEEK_OF_YEAR: " +
    now.get(Calendar.WEEK_OF_YEAR));
System.out.println("WEEK_OF_MONTH: " +
    now.get(Calendar.WEEK_OF_MONTH));
System.out.println("DATE: " + now.get(Calendar.DATE));
System.out.println("DAY_OF_MONTH: " +
    now.get(Calendar.DAY_OF_MONTH));
System.out.println("DAY_OF_YEAR: " +
    now.get(Calendar.DAY_OF_YEAR));
System.out.println("DAY_OF_WEEK: " +
    now.get(Calendar.DAY_OF_WEEK));
```

4. Add more statements that display information about the current time, as follows:

```
System.out.println("AM_PM: " +
    now.get(Calendar.AM_PM));
System.out.println("HOUR: " + now.get(Calendar.HOUR));
System.out.println("HOUR_OF_DAY: " +
    now.get(Calendar.HOUR_OF_DAY));
System.out.println("MINUTE: " +
    now.get(Calendar.MINUTE));
System.out.println("SECOND: " +
    now.get(Calendar.SECOND));
System.out.println("MILLISECOND: " +
    now.get(Calendar.MILLISECOND));
```



5. Add the closing curly brace for the `main()` method and the closing curly brace for the class.
6. Save the file as **CalendarDemo.java**. Compile and execute the program. Figure 4-43 shows the output from the program when it is executed a little after 2 p.m. on Wednesday, June 20, 2012. Notice that the month of June is represented by 5—the month values in the `GregorianCalendar` are 0 through 11. When you display month values in your own programs, you might choose to add 1 to any value before displaying it, so that users see month numbers to which they are accustomed.



```

C:\Java>java CalendarDemo
YEAR: 2012
MONTH: 5
WEEK_OF_YEAR: 25
WEEK_OF_MONTH: 4
DATE: 20
DAY_OF_MONTH: 20
DAY_OF_YEAR: 172
DAY_OF_WEEK: 4
AM_PM: 1
HOUR: 2
HOUR_OF_DAY: 14
MINUTE: 20
SECOND: 42
MILLISECOND: 132

C:\Java>

```

**Figure 4-43** Output of the `CalendarDemo` application

## Creating an Interactive Application with a Timer

Next, you will use the `GregorianCalendar` class to create an application that outputs a user's response time to a question.

### To create a timed interactive application:

1. Open a new file in your text editor, and type the following two `import` statements. You need the `JOptionPane` class to use the `showConfirmDialog()` method, and you need the `java.util` package to use the `GregorianCalendar` class:

```

import javax.swing.JOptionPane;
import java.util.*;

```

2. Begin the `DialogTimer` application as follows. Declare variables named `milli1`, `milli2`, `sec1`, and `sec2`. These will be used to compute `time1` and `time2` from calendar objects created at the beginning and end of the program. You then use `time1` and `time2` to compute a `timeDifference`. Also declare a constant to hold the number of milliseconds in a second.

```

public class DialogTimer
{
    public static void main(String[] args)
    {
        int time1, time2, milli1, milli2, sec1,
            sec2, timeDifference;
        final int MILLISECS_IN_SECOND = 1000;
    }
}

```

3. Instantiate a `GregorianCalendar` object, and retrieve its `MILLISECOND` and `SECOND` values. Compute a `time1` value by multiplying the current `sec1` value by 1000 and adding it to the current `milli1` value:

```
GregorianCalendar before = new GregorianCalendar();
milli1 = before.get(GregorianCalendar.MILLISECOND);
sec1 = before.get(GregorianCalendar.SECOND);
time1 = MILLISECS_IN_SECOND * sec1 + milli1;
```

4. Display a dialog box that asks the user to make a difficult choice:

```
JOptionPane.showConfirmDialog
    (null, "Is stealing ever justified? ");
```

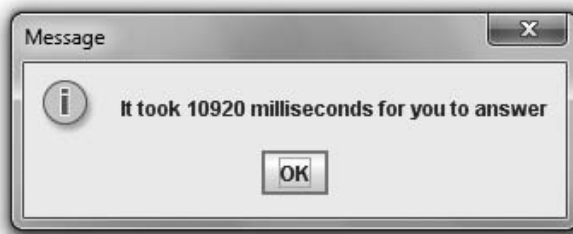
5. Next, create a new `GregorianCalendar` object. This statement does not execute until the user provides a response for the dialog box, so the time variables contain different values from the first `GregorianCalendar` object created:

```
GregorianCalendar after = new GregorianCalendar();
milli2 = after.get(GregorianCalendar.MILLISECOND);
sec2 = after.get(GregorianCalendar.SECOND);
time2 = MILLISECS_IN_SECOND * sec2 + milli2;
```

6. Compute the difference between the times, and display the result in a dialog box.

```
timeDifference = time2 - time1;
JOptionPane.showMessageDialog(null, "It took " +
    timeDifference + " milliseconds for you to answer");
```

7. Add two closing curly braces—one for the method and the other for the class—and then save the file as **DialogTimer.java**.
8. Compile and execute the program. When the question appears, choose a response. The second output looks like Figure 4-44; the actual time displayed varies depending on how long you wait before selecting an answer.



**Figure 4-44** Output of the `DialogTimer` application

9. The output in the `DialogTimer` application is accurate only when the first and second `GregorianCalendar` objects are created during the same minute. For example, if the first object is created a few seconds before a new minute starts, and the second object is created a few seconds after the new minute starts, the second `SECOND` value appears to be much lower than the first one. On your own, modify the `DialogTimer` application to rectify this discrepancy. Save the file as **DialogTimer2.java**.

## Don't Do It

- Don't try to use a variable that is out of scope.
- Don't assume that a constant is still a constant when passed to a method's parameter. If you want a parameter to be constant within a method, you must use `final` in the parameter list.
- Don't overload methods by giving them different return types. If their identifiers and parameter lists are the same, then two methods are ambiguous no matter what their return types are.
- Don't think that *default constructor* means only the automatically supplied version. A constructor with no parameters is a default constructor, whether it is the one that is automatically supplied or one you write.
- Don't forget to write a default constructor for a class that has other constructors if you want to be able to instantiate objects without using arguments.

## Key Terms

A **block** is the code between a pair of curly braces.

An **outside block**, or **outer block**, contains another block.

An **inside block**, or **inner block**, is contained within another block.

An inside block is **nested** within an outside block.

A variable comes into existence, or **comes into scope**, when you declare it.

A variable ceases to exist, or **goes out of scope**, at the end of the block in which it is declared.

To **redeclare a variable** is to attempt to declare it twice—an illegal action.

A variable **overrides** another with the same name when it takes precedence over the other variable.

**Overloading** involves using one term to indicate diverse meanings, or writing multiple methods with the same name but with different arguments.

An **ambiguous** situation is one in which the compiler cannot determine which method to use.

A **reference** is an object's memory address.

The **this reference** is a reference to an object that is passed to any object's nonstatic class method.

**Class methods** are static methods that do not have a `this` reference (because they have no object associated with them).

**Class variables** are static variables that are shared by every instantiation of a class.

A **package** is a library of classes.

A **library of classes** is a folder that provides a convenient grouping for classes.

The `java.lang` package is implicitly imported into every Java program.

The **fundamental classes** are basic classes contained in the `java.lang` package that are automatically imported into every program you write.

The **optional classes** reside in packages that must be explicitly imported into your programs.

**NaN** is a three-letter abbreviation for “Not a Number.”

A **wildcard symbol** is an asterisk—a symbol used to indicate that it can be replaced by any set of characters. In a Java `import` statement, you use a wildcard symbol to represent all the classes in a package.

**Composition** describes the relationship between classes when an object of one class is a data field within another class.

A **has-a relationship** is a relationship based on composition.

**Nested classes** are classes contained in other classes.

The **top-level class** is the containing class in nested classes.

A **static member class** is a type of nested class that has access to all `static` methods of its top-level class.

**Nonstatic member classes**, also known as **inner classes**, are nested classes that require an instance.

**Local classes** are a type of nested class that are local to a block of code.

**Anonymous classes** are nested, local classes that have no identifier.

## Chapter Summary

- A variable’s scope is the portion of a program within which you can reference that variable. A block is the code between a pair of curly braces. Within a method, you can declare a variable with the same name multiple times, as long as each declaration is in its own nonoverlapping block. If you declare a variable within a class and use the same variable name within a method of the class, the variable used inside the method takes precedence over (or overrides, or masks) the first variable.
- Overloading involves writing multiple methods with the same name but different argument lists. Methods that have identical argument lists but different return types are not overloaded; they are illegal.
- When you overload methods, you risk creating an ambiguous situation—one in which the compiler cannot determine which method to use. Constructors can receive arguments and be overloaded. If you explicitly create a constructor for a class, the automatically created constructor no longer exists.

- When you write your own constructors, they can receive parameters. Such parameters are often used to initialize data fields for an object. After you write a constructor for a class, you no longer receive the automatically provided default constructor. If a class's only constructor requires an argument, you must provide an argument for every object of the class that you create. You can overload constructors just as you can other methods.
- Within nonstatic methods, data fields for the correct object are accessed because you implicitly pass a `this` reference to class methods. Static methods do not have a `this` reference because they have no object associated with them; static methods are also called class methods.
- Static class variables are variables that are shared by every instantiation of a class.
- When a field in a class is `static`, it is shared by each instantiation; when it is `final` it cannot change.
- Java contains hundreds of prewritten classes that are stored in packages, which are folders that provide convenient groupings for classes. The package that is implicitly imported into every Java program is named `java.lang`. The classes it contains are the fundamental classes, as opposed to the optional classes, which must be explicitly named. The class `java.lang.Math` contains constants and methods that can be used to perform common mathematical functions. The `GregorianCalendar` class allows you to define and manipulate dates and time.
- A class can contain other objects as data members. Composition describes the relationship between classes when an object of one class is a data field within another class.
- You can create nested classes that are stored in the same file. The most common reason to nest a class inside another is because the inner class is used only by the outer or top-level class; in other words, it is a “helper class” to the top-level class.

## Review Questions

1. The code between a pair of curly braces in a method is a \_\_\_\_\_.
  - a. function
  - b. block
  - c. brick
  - d. sector
2. When a block exists within another block, the blocks are \_\_\_\_\_.
  - a. structured
  - b. nested
  - c. sheltered
  - d. illegal
3. The portion of a program within which you can reference a variable is the variable's \_\_\_\_\_.
  - a. range
  - b. space
  - c. domain
  - d. scope

4. You can declare variables with the same name multiple times \_\_\_\_\_.
  - a. within a statement
  - b. within a block
  - c. within a method
  - d. You never can declare multiple variables with the same name.
5. If you declare a variable as an instance variable within a class, and you declare and use the same variable name within a method of the class, then within the method, \_\_\_\_\_.
  - a. the variable used inside the method takes precedence
  - b. the class instance variable takes precedence
  - c. the two variables refer to a single memory address
  - d. an error will occur
6. A method variable will \_\_\_\_\_ a class variable with the same name.
  - a. acquiesce to
  - b. destroy
  - c. override
  - d. alter
7. Nonambiguous, overloaded methods must have the same \_\_\_\_\_.
  - a. name
  - b. number of parameters
  - c. parameter names
  - d. types of parameters
8. If a method is written to receive a `double` parameter, and you pass an integer to the method, then the method will \_\_\_\_\_.
  - a. work correctly; the integer will be promoted to a `double`
  - b. work correctly; the integer will remain an integer
  - c. execute, but any output will be incorrect
  - d. not work; an error message will be issued
9. A constructor \_\_\_\_\_ parameters.
  - a. can receive
  - b. cannot receive
  - c. must receive
  - d. can receive a maximum of 10
10. A constructor \_\_\_\_\_ overloaded.
  - a. can be
  - b. cannot be
  - c. must be
  - d. is always automatically
11. Usually, you want each instantiation of a class to have its own copy of \_\_\_\_\_.
  - a. the data fields
  - b. the class methods
  - c. both of the above
  - d. none of the above

12. If you create a class that contains one method, and instantiate two objects, you usually store \_\_\_\_\_ for use with the objects.
- one copy of the method
  - two copies of the method
  - two different methods containing two different `this` references
  - data only (the methods are not stored)
13. The `this` reference \_\_\_\_\_.
- can be used implicitly
  - must be used implicitly
  - must not be used implicitly
  - must not be used
14. Methods that you reference with individual objects are \_\_\_\_\_.
- `private`
  - `public`
  - `static`
  - `nonstatic`
15. Variables that are shared by every instantiation of a class are \_\_\_\_\_.
- class variables
  - `private` variables
  - `public` variables
  - illegal
16. The keyword `final` used with a variable declaration indicates \_\_\_\_\_.
- the end of the program
  - a `static` field
  - a symbolic constant
  - that no more variables will be declared in the program
17. Java classes are stored in a folder or \_\_\_\_\_.
- packet
  - package
  - bundle
  - gaggle
18. Which of the following statements determines the square root of a number and assigns it to the variable `s`?
- `s = sqrt(number);`
  - `s = Math.sqrt(number);`
  - `number = sqrt(s);`
  - `number = Math.sqrt(s);`
19. A `GregorianCalendar` object can be created with one of seven constructors. This means that the constructors \_\_\_\_\_.
- override each other
  - are ambiguous
  - are overloaded
  - all of the above
20. The `GregorianCalendar` class `get()` method always returns a(n) \_\_\_\_\_.
- day of the week
  - date
  - integer
  - `GregorianCalendar` object

## Exercises

1.
  - a. Create a class named `Commission` that includes three variables: a `double` sales figure, a `double` commission rate, and an `int` commission rate. Create two overloaded methods named `computeCommission()`. The first method takes two `double` parameters representing sales and rate, multiplies them, and then displays the results. The second method takes two parameters: a `double` sales figure and an integer commission rate. This method must divide the commission rate figure by 100.0 before multiplying by the sales figure and displaying the commission. Supply appropriate values for the variables, and write a `main()` method that tests each overloaded method. Save the file as **Commission.java**.
  - b. Add a third overloaded method to the `Commission` application you created in Exercise 1a. The third overloaded method takes a single parameter representing sales. When this method is called, the commission rate is assumed to be 7.5%, and the results are displayed. To test this method, add an appropriate call in the `Commission` program's `main()` method. Save the application as **Commission2.java**.
2. Create a class named `Pay` that includes five `double` variables that hold hours worked, rate of pay per hour, withholding rate, gross pay, and net pay. Create three overloaded `computeNetPay()` methods. When `computeNetPay()` receives values for hours, pay rate, and withholding rate, it computes the gross pay and reduces it by the appropriate withholding amount to produce the net pay. (Gross pay is computed as hours worked multiplied by pay per hour.) When `computeNetPay()` receives two parameters, they represent the hours and pay rate, and the withholding rate is assumed to be 15%. When `computeNetPay()` receives one parameter, it represents the number of hours worked, the withholding rate is assumed to be 15%, and the hourly rate is assumed to be 5.85. Write a `main()` method that tests all three overloaded methods. Save the application as **Pay.java**.
3.
  - a. Create a class named `Household` that includes data fields for the number of occupants and the annual income, as well as methods to get and set each field. In addition, create a default constructor that automatically sets the occupants field to 1 and the income field to 0. Save this file as **Household.java**. Create an application named `TestHousehold` that demonstrates each method works correctly. Save the file as **TestHousehold.java**.
  - b. Create an additional overloaded constructor for the `Household` class you created in Exercise 3a. This constructor receives an integer parameter and assigns the value to the occupants field. Add any needed statements to `TestHousehold` to ensure that the overloaded constructor works correctly, save it, and then test it.
  - c. Create a third overloaded constructor for the `Household` class you created in Exercises 3a and 3b. This constructor receives two parameters, the values of which are assigned to the occupants and income fields, respectively. Alter the `TestHousehold` application to demonstrate that each version of the constructor works properly. Save the application, and then compile and test it.



4. Create a class named `Box` that includes integer data fields for length, width, and height. Create three constructors that require one, two, and three parameters, respectively. When one argument is passed to the constructor, assign it to length, assign zeros to height and width, and display “Line created”. When two arguments are used, assign them to length and width, assign zero to height, and display “Rectangle created”. When three arguments are used, assign them to the three variables and display “Box created”. Save this file as **Box.java**. Create an application named `TestBox` that demonstrates each method works correctly. Save the application as **TestBox.java**.
5. Create a class named `Shirt` with data fields for collar size and sleeve length. Include a constructor that takes parameters for each field. Also include a `final, static String` named `MATERIAL` and initialize it to *cotton*. Write an application named `TestShirt` to instantiate three `Shirt` objects with different collar sizes and sleeve lengths, and then display all the data, including material, for each shirt. Save both the **Shirt.java** and **TestShirt.java** files.
6.
  - a. Create a class named `Circle` with fields named `radius`, `diameter`, and `area`. Include a constructor that sets the radius to 1 and calculates the other two values. Also include methods named `setRadius()` and `getRadius()`. The `setRadius()` method not only sets the radius, it also calculates the other two values. (The diameter of a circle is twice the radius, and the area of a circle is  $\pi$  multiplied by the square of the radius.) Save the class as **Circle.java**.
  - b. Create a class named `TestCircle` whose `main()` method declares several `Circle` objects. Using the `setRadius()` method, assign one `Circle` a small radius value, and assign another a larger radius value. Do not assign a value to the radius of the third circle; instead, retain the value assigned at construction. Display all the values for all the `Circle` objects. Save the application as **TestCircle.java**.
7. Write a Java application that uses the `Math` class to determine the answers for each of the following:
  - a. The square root of 30
  - b. The sine and cosine of 100
  - c. The value of the floor, ceiling, and round of 44.7
  - d. The larger and the smaller of the character `K` and the integer 70
  - e. A random number between 0 and 10 (*Hint*: The `random()` method returns a value between 0 and 1; you want a number that is 10 times larger.)Save the application as **MathTest.java**.
8. Write an application to calculate how many days it is from today until the first day of next summer (assume that this date is June 21). Save the file as **Summer.java**.
9. Write an application to calculate how many days it is from today until the end of the current year. Save the file as **YearEnd.java**.
10.
  - a. Create a `CollegeStudent` class. The class contains data fields that hold a student’s first name, last name, enrollment date, and projected graduation date,

using `GregorianCalendar` objects for each date. Provide `get()` and `set()` methods for each field. Also provide a constructor that requires first and last names and enrollment date, and sets the projected graduation date to exactly four years after enrollment. Save the class as **CollegeStudent.java**.

- b. Create an interactive application that prompts the user for data for two `CollegeStudent` objects. Prompt the user for first name, last name, enrollment month, enrollment day, and enrollment year for each `CollegeStudent`, and then instantiate the objects. Display all the values, including projected graduation dates. Save the application as **TestCollegeStudent.java**.
11. In Deep Water Associates operates a business that offers a variety of services to customers who own swimming pools, including cleaning and filling pools. Write a program that calculates the price of a service call. The price includes a set \$75 fee for cleaning plus an additional fee based on the amount of time it will take to fill a customer's pool with water. Table 4-3 provides the necessary parameters for estimating the price (based on the fill-up time) for a pool. Write an application that prompts the user for the length, width, and depth of a pool, and calculates the service and fill-up price. Save the application as **Swimming.java**.

| Parameter                 | Explanation                                 |
|---------------------------|---------------------------------------------|
| Fee for cleaning          | \$75                                        |
| Pool volume in cubic feet | length * width * average depth, all in feet |
| Gallons per cubic foot    | 7.5                                         |
| Pool capacity in gallons  | volume * gallons per cubic foot             |
| Rate of flow              | 50 gallons per minute                       |
| Minutes per hour          | 60                                          |
| Fee per hour for filling  | \$8                                         |

**Table 4-3** Parameters for estimating pool fill-up price



### Debugging Exercise

12. Each of the following files in the Chapter.04 folder of your downloadable student files has syntax and/or logic errors. In each case, determine the problem and fix the program. After you correct the errors, save each file using the same filename preceded with Fix. For example, save `DebugFour1.java` as `FixDebugFour1.java`.
  - a. `DebugFour1.java`
  - b. `DebugFour2.java`
  - c. `DebugFour3.java` and `DebugBox.java`
  - d. `DebugFour4.java`



When you change a filename, remember to change every instance of the class name within the file so that it matches the new filename. In Java, the filename and class name must always match.



## Game Zone

209

13. Dice are used in many games. One die can be thrown to randomly show a value from 1 through 6. Design a `Die` class that can hold an integer data field for a value (from 1 to 6). Include a constructor that randomly assigns a value to a die object. Appendix D contains information on generating random numbers. To fully understand the process, you must learn more about Java classes and methods. However, for now, you can copy the following statement to generate a random number between 1 and 6 and assign it to a variable. Using this statement assumes you have assigned appropriate values to the static constants.

```
randomValue = ((int)(Math.random() * 100) % HIGHEST_DIE_VALUE +
LOWEST_DIE_VALUE);
```

Also include a method in the class to return a die's value. Save the class as **Die.java**.

Write an application that randomly “throws” two dice and displays their values. After you read the chapter *Making Decisions*, you will be able to have the game determine the higher die. For now, just observe how the values change as you execute the program multiple times. Save the application as **TwoDice.java**.

14. Using the `Die` class, write an application that randomly “throws” five dice for the computer and five dice for the player. Display the values and then, by observing the results, decide who wins based on the following hierarchy of `Die` values. (The computer will not decide the winner; the player will determine the winner based on observation.) Any higher combination beats a lower one; for example, five of a kind beats four of a kind.
- ♦ Five of a kind
  - ♦ Four of a kind
  - ♦ Three of a kind
  - ♦ A pair

After you learn about decision making in the next chapter, you will be able to make the program determine whether you or the computer had the better roll, and after you read the chapter *Introduction to Arrays*, you will be able to make the determination more efficient. For now, just observe how the values change as you execute the program multiple times. Save the application as **FiveDice.java**.

*This page intentionally left blank*

# Making Decisions

In this chapter, you will:

- ⦿ Plan decision-making logic
- ⦿ Make decisions with the `if` and `if...else` structures
- ⦿ Use multiple statements in an `if` or `if...else` structure
- ⦿ Nest `if` and `if...else` statements
- ⦿ Use AND and OR operators
- ⦿ Make accurate and efficient decisions
- ⦿ Use the `switch` statement
- ⦿ Use the conditional and NOT operators
- ⦿ Assess operator precedence

## Planning Decision-Making Logic

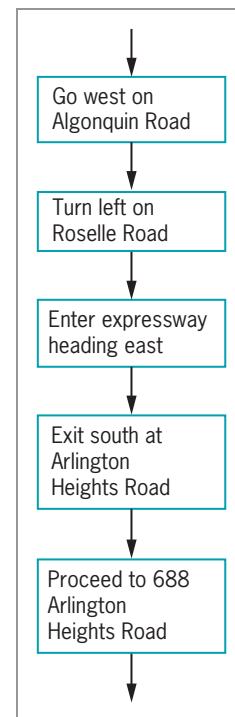
When computer programmers write programs, they rarely just sit down at a keyboard and begin typing. Programmers must plan the complex portions of programs using paper and pencil. Programmers often use **pseudocode**, a tool that helps them plan a program's logic by writing plain English statements. Using pseudocode requires that you write down the steps needed to accomplish a given task. You write pseudocode in everyday language, not the syntax used in a programming language. In fact, a task you write in pseudocode does not have to be computer-related. If you have ever written a list of directions to your house—for example, (1) go west on Algonquin Road, (2) turn left on Roselle Road, (3) enter expressway heading east, and so on—you have written pseudocode. A **flowchart** is similar to pseudocode, but you write the steps in diagram form, as a series of shapes connected by arrows.



You learned the difference between a program's logic and its syntax in Chapter 1.

Some programmers use a variety of shapes to represent different tasks in their flowcharts, but you can draw simple flowcharts that express very complex situations using just rectangles and diamonds. You use a rectangle to represent any unconditional step and a diamond to represent any decision. For example, Figure 5-1 shows a flowchart describing driving directions to a friend's house. The logic in Figure 5-1 is an example of a logical structure called a **sequence structure**—one step follows another unconditionally. A sequence structure might contain any number of steps, but when one task follows another with no chance to branch away or skip a step, you are using a sequence.

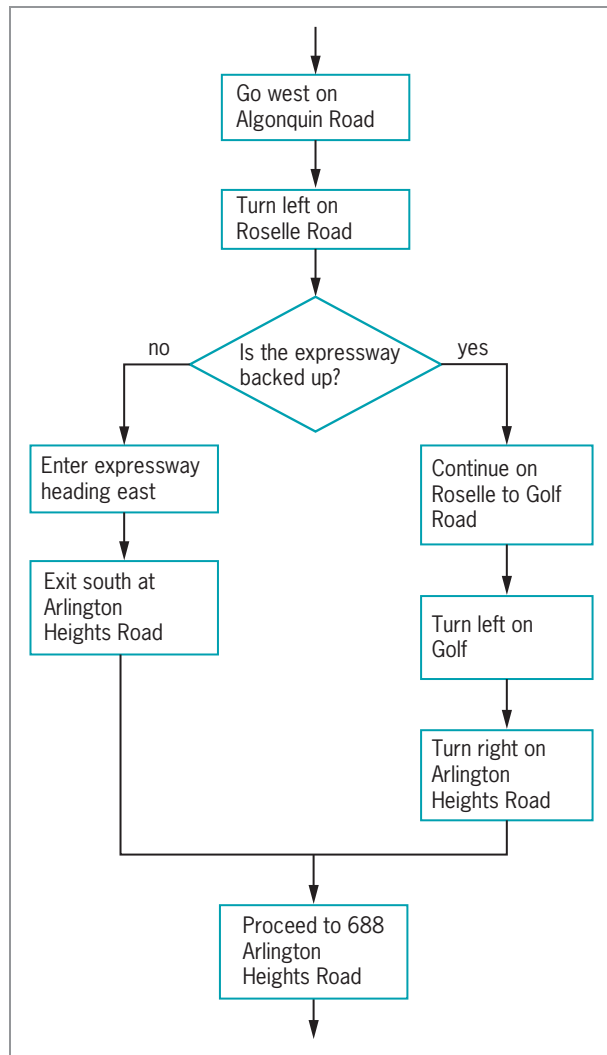
Sometimes, logical steps do not follow in an unconditional sequence—some tasks might or might not occur based on decisions you make. Using diamond shapes, flowchart creators draw paths to alternative courses of action starting from the sides of the diamonds. Figure 5-2 shows a flowchart describing directions in which the execution of some steps depends on decisions.



**Figure 5-1** Flowchart of a series of sequential steps

Figure 5-2 includes a **decision structure**—one that involves choosing between alternative courses of action based on some value within a program. For example, the program that produces your paycheck can make decisions about the proper amount to withhold for taxes, the program that guides a missile can alter its course, and a program that monitors your blood pressure during surgery can determine when to sound an alarm. Making decisions is what makes computer programs seem “smart.”

When reduced to their most basic form, all computer decisions are yes-or-no decisions. That is, the answer to every computer question is yes or no (or true or false, or on or off). This is because computer circuitry consists of millions of tiny switches that are either on or off, and the result of every decision sets one of these switches in memory. As you learned in Chapter 2, the values `true` and `are` **Boolean values**; every computer decision results in a Boolean value. Thus, internally, a program you write never asks, for example, “What number did the user enter?” Instead, the decisions might be “Did the user enter a 1?” “If not, did the user enter a 2?” “If not, did the user enter a 3?”



**Figure 5-2** Flowchart including a decision



Sir George Boole lived from 1815 to 1864. He developed a type of linguistic algebra, based on 0s and 1s, the three most basic operations of which were (and still are) AND, OR, and NOT. All computer logic is based on his discoveries.

## TWO TRUTHS & A LIE

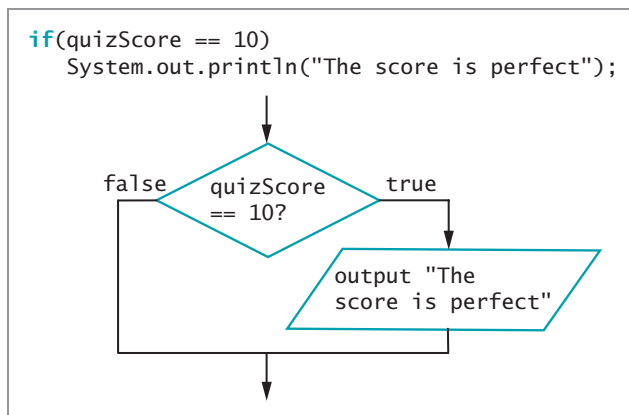
### Planning Decision-Making Logic

1. Pseudocode and flowcharts are both tools that are used to check the syntax of computer programs.
2. In a sequence structure, one step follows another unconditionally.
3. In a decision structure, alternative courses of action are chosen based on a Boolean value.

The false statement is #1. Pseudocode and flowcharts are both tools that help programmers plan a program's logic.

## The if and if...else Structures

In Java, the simplest statement you can use to make a decision is the **if statement**. For example, suppose you have declared an integer variable named `quizScore`, and you want to display a message when the value of `quizScore` is 10. The following `if` statement makes the decision to produce output. Note that the double equal sign (`==`) is used to determine equality; it is Java's **equivalency operator**. Figure 5-3 shows a Java `if` statement and a diagram of its logic.



Traditionally, flowcharts use diamond shapes to hold decisions and rectangles to represent actions. Even though input and output statements represent actions, many flowchart creators prefer to show them in parallelograms; this book follows that convention.

**Figure 5-3** A Java `if` statement

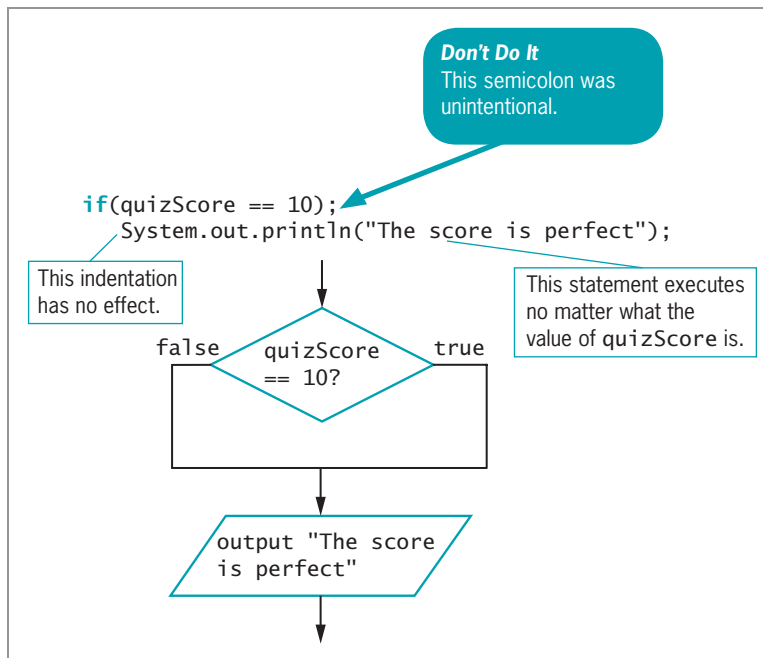
In this example, if `quizScore` holds the value 10, the Boolean value of the expression `quizScore == 10` is `true`, and the subsequent `println()` statement executes. If the value of the expression `quizScore == 10` is `false`, the `println()` statement does not execute. Either way, the program continues and executes any statements that follow the `if` statement.



An if statement always includes parentheses. Within the parentheses, you can place any Boolean expression. Most often you use a comparison that includes one of the relational operators you learned about in Chapter 2 ( ==, <, >, <=, >=, or != ). However, you can use any expression that evaluates as true or false, such as a simple boolean variable or a method that returns a boolean value.

## Pitfall: Misplacing a Semicolon in an if Statement

In a Java if statement, the Boolean expression, such as (quizScore == 10), must appear within parentheses. In Figure 5-3 there is no semicolon at the end of the first line of the if statement because the statement does not end there. The statement ends after the println() call, so that is where you type the semicolon. You could type the entire if statement on one line and it would execute correctly; however, the two-line format for the if statement is more conventional and easier to read, so you usually type if and the Boolean expression on one line, press Enter, and then indent a few spaces before coding the action that will occur if the Boolean expression evaluates as true. Be careful—if you use the two-line format and type a semicolon at the end of the first line, as in the example shown in Figure 5-4, the results might not be what you intended.



**Figure 5-4** Logic that executes when an extra semicolon is inserted in an if statement

When the Boolean expression in Figure 5-4 is true, an **empty statement** that contains only a semicolon executes. Whether the tested expression evaluates as true or false, the decision is over immediately, and execution continues with the next independent statement that displays a message. In this case, because of the incorrect semicolon, the `if` statement accomplishes nothing.

216

## Pitfall: Using the Assignment Operator Instead of the Equivalency Operator

Another common programming error occurs when a programmer uses a single equal sign rather than the double equal sign when attempting to determine equivalency. The expression `quizScore = 10` does not compare `quizScore` to 10; instead, it attempts to assign the value 10 to `quizScore`. When the expression `quizScore = 10` is used in the `if` statement, the assignment is illegal because only Boolean expressions are allowed. The confusion arises in part because the single equal sign is used within Boolean expressions in `if` statements in several older programming languages, such as COBOL, Pascal, and BASIC. Adding to the confusion, Java programmers use the word *equals* when speaking of equivalencies. For example, you might say, “If `quizScore equals 10...`”.



The expression `if(x = true)` will compile only if `x` is a `boolean` variable, because it would be legal to assign `true` to `x`. However, such a statement would be useless because the value of such an expression could never be `false`.

An alternative to using a Boolean expression in an `if` statement, such as `quizScore == 10`, is to store the Boolean expression’s value in a Boolean variable. For example, if `isPerfectScore` is a Boolean variable, then the following statement compares `quizScore` to 10 and stores `true` or `false` in `isPerfectScore`:

```
isPerfectScore = (quizScore == 10);
```

Then, you can write the `if` as:

```
if(isPerfectScore)
    System.out.println("The score is perfect");
```

This adds an extra step to the program, but makes the `if` statement more similar to an English-language statement.



When comparing a variable to a constant, some programmers prefer to place the constant to the left of the comparison operator, as in `10 == quizScore`. This practice is a holdover from other programming languages, such as C++, in which an accidental assignment might be made when the programmer types the assignment operator (a single equal sign) instead of the comparison operator (the double equal sign). In Java, the compiler does not allow you to make a mistaken assignment in a Boolean expression.

## Pitfall: Attempting to Compare Objects Using the Relational Operators

You can use the standard relational operators (`==`, `<`, `>`, `<=`, `>=`, and `!=`) to compare the values of primitive data types such as `int` and `double`. However, you cannot use `<`, `>`, `<=`, or `>=` to

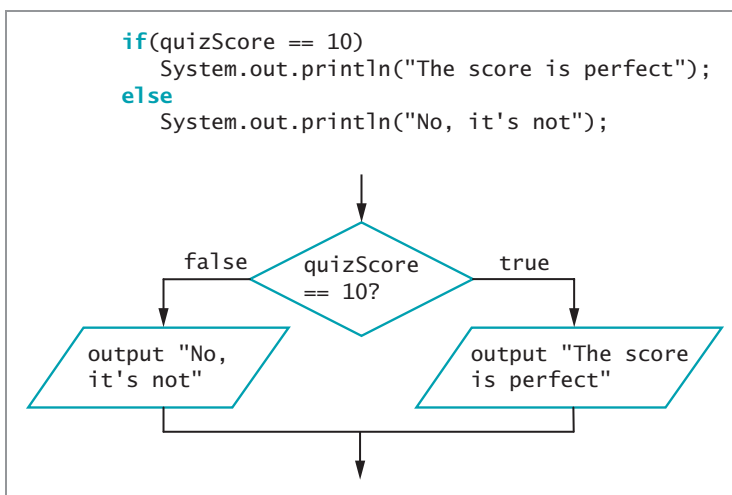
compare objects; a program containing such comparisons does not compile. You can use the equals and not equals comparisons (`==` and `!=`) with objects, but when you use them, you compare the objects' memory addresses instead of their values. Recall that every object name is a reference; the equivalency operators compare objects' references. In other words, `==` only yields `true` for two objects when they refer to the same object in memory, not when they are different objects with the same value. To compare the values of objects, you should write specialized methods. Remember, `Strings` are objects, so do not use `==` to compare `Strings`. You will learn more about this in the chapter *Characters, Strings, and the StringBuffer*.

## The if...else Structure

Consider the following statement:

```
if(quizScore == 10)
    System.out.println("The score is perfect");
```

Such a statement is sometimes called a **single-alternative if** because you only perform an action, or not, based on one alternative; in this example, you display a statement when `quizScore` is 10. Often, you require two options for the course of action following a decision. A **dual-alternative if** is the decision structure you use when you need to take one or the other of two possible courses of action. For example, you would use a dual-alternative `if` structure if you wanted to display one message when the value of `quizScore` is 10 and a different message when it is not. In Java, the **if...else statement** provides the mechanism to perform one action when a Boolean expression evaluates as `true`, and to perform a different action when a Boolean expression evaluates as `false`. The code in Figure 5-5 displays one of two messages. In this example, when the value of `quizScore` is 10, the message “The score is perfect” is displayed. When `quizScore` is any other value, the program displays the message “No, it’s not”. You can code an `if` without an `else`, but it is illegal to code an `else` without an `if`.



**Figure 5-5** An if...else structure



The indentation shown in the example code in Figure 5-5 is not required, but is standard usage. You vertically align the keyword `if` with the keyword `else`, and then indent the action statements that depend on the evaluation.

218

When you execute an `if...else` statement, only one of the resulting actions takes place depending on the evaluation of the Boolean expression. Each statement, the one following the `if` and the one following the `else`, is a complete statement, so each ends with a semicolon.



Watch the video *Making Decisions*.

## TWO TRUTHS & A LIE

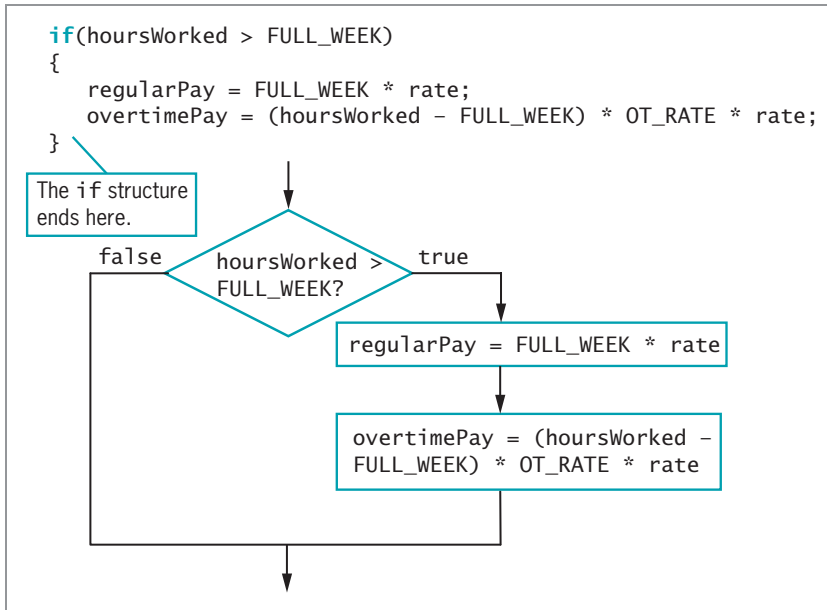
### The `if` and `if...else` Structures

1. In a Java `if` statement, the keyword `if` is followed by a Boolean expression within parentheses.
2. In a Java `if` statement, a semicolon follows the Boolean expression.
3. When determining equivalency in Java, you use a double equal sign.

The false statement is #2. In a Java `if` statement, a semicolon ends the statement. It is used following the action that should occur if the Boolean expression is true. If a semicolon follows the Boolean expression, then the body of the `if` statement is empty.

## Using Multiple Statements in an `if` or `if...else` Structure

Often, you want to take more than one action following the evaluation of a Boolean expression within an `if` statement. For example, you might want to display several separate lines of output or perform several mathematical calculations. To execute more than one statement that depends on the evaluation of a Boolean expression, you use a pair of curly braces to place the dependent statements within a block. For example, the program segment shown in Figure 5-6 determines whether an employee has worked more than the value of a `FULL_WEEK` constant; if so, the program computes regular and overtime pay.

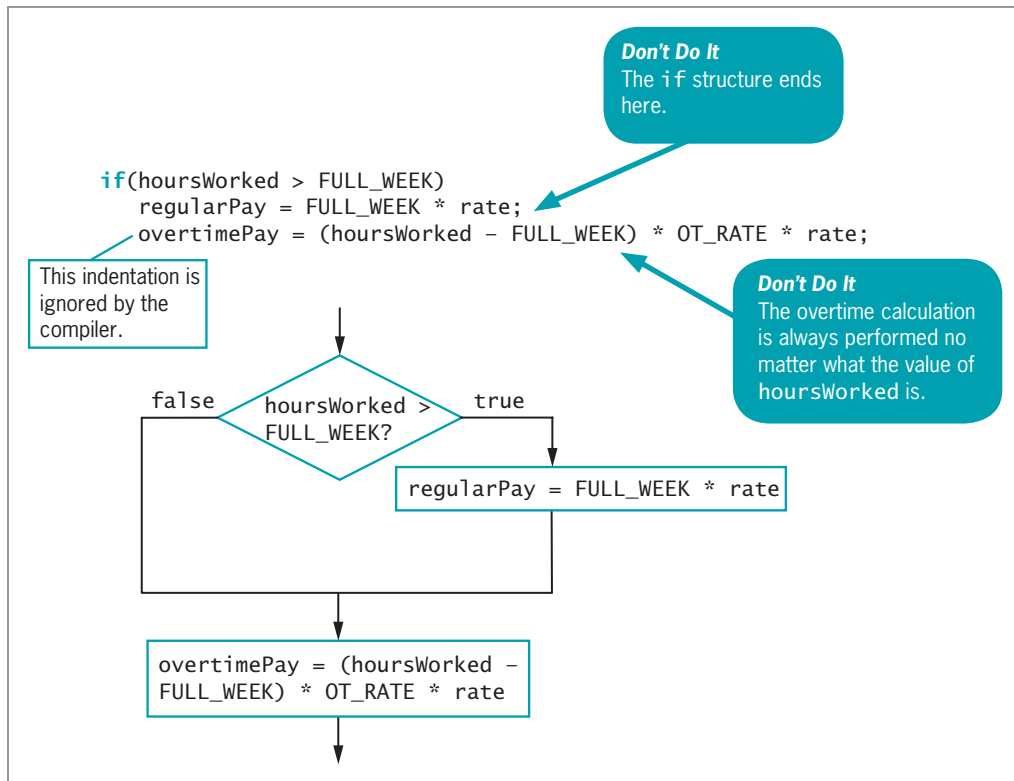


**Figure 5-6** An if structure that determines pay



In Figure 5-6, no action is taken if `hoursWorked` is less than the value of `FULL_WEEK`. An actual payroll calculation would include more comprehensive instructions, but they are not necessary for the sake of the example.

When you place a block within an if statement, it is crucial to place the curly braces correctly. For example, in Figure 5-7, the curly braces have been omitted. Within the code segment in Figure 5-7, when `hoursWorked > FULL_WEEK` is true, `regularPay` is calculated and the if expression ends. The next statement that computes `overtimePay` executes every time the program runs, no matter what value is stored in `hoursWorked`. This last statement does not depend on the if statement; it is an independent, stand-alone statement. The indentation might be deceiving; it looks as though two statements depend on the if statement, but indentation does not cause statements following an if statement to be dependent. Rather, curly braces are required if multiple statements must be treated as a block. When you create a block, you do not have to place multiple statements within it. It is perfectly legal to place curly braces around a single statement.



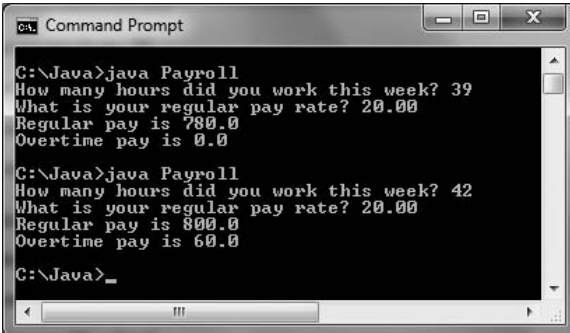
**Figure 5-7** Erroneous overtime pay calculation with missing curly braces

Because the curly braces are missing, regardless of whether `hoursWorked` is more than `FULL_WEEK`, the last statement in Figure 5-7 is a new stand-alone statement that is not part of the `if`, and so it always executes. If `hoursWorked` is 30, for example, and `FULL_WEEK` is 40, then the program calculates the value of `overtimePay` as a negative number (because 30 minus 40 results in  $-10$ ). Therefore, the output is incorrect. Correct blocking is crucial to achieving valid output.

Just as you can block statements to depend on an `if`, you can also block statements to depend on an `else`. Figure 5-8 shows an application that contains an `if` structure with two dependent statements and an `else` with two dependent statements. The program executes the final `println()` statement without regard to the `hoursWorked` variable's value; it is not part of the `if` structure. Figure 5-9 shows the output from two executions of the program. In the first execution, the user entered 39 for the `hoursWorked` value and 20.00 for `rate`; in the second execution, the user entered 42 for `hoursWorked` and 20.00 for `rate`.

```
import java.util.Scanner;
public class Payroll
{
    public static void main(String[] args)
    {
        double rate;
        double hoursWorked;
        double regularPay;
        double overtimePay;
        final int FULL_WEEK = 40;
        final double OT_RATE = 1.5;
        Scanner keyboard = new Scanner(System.in);
        System.out.print("How many hours did you work this week? ");
        hoursWorked = keyboard.nextDouble();
        System.out.print("What is your regular pay rate? ");
        rate = keyboard.nextDouble();
        if(hoursWorked > FULL_WEEK)
        {
            regularPay = FULL_WEEK * rate;
            overtimePay = (hoursWorked - FULL_WEEK) * OT_RATE * rate;
        }
        else
        {
            regularPay = hoursWorked * rate;
            overtimePay = 0.0;
        }
        System.out.println("Regular pay is " +
            regularPay + "\nOvertime pay is " + overtimePay);
    }
}
```

Figure 5-8 Payroll application containing an if and else with blocks



```
CA: Command Prompt
C:\Java>java Payroll
How many hours did you work this week? 39
What is your regular pay rate? 20.00
Regular pay is 780.0
Overtime pay is 0.0

C:\Java>java Payroll
How many hours did you work this week? 42
What is your regular pay rate? 20.00
Regular pay is 800.0
Overtime pay is 60.0

C:\Java>_
```

Figure 5-9 Output of the Payroll application



When you block statements, you must remember that any variable you declare within a block is local to that block. For example, the following code segment contains a variable named `sum` that is local to the block following the `if`. The last `println()` statement causes an error because the `sum` variable is not recognized:

```
if(a == b)
{
    int sum = a + b;
    System.out.println
        ("The two variables are equal");
}
System.out.println("The sum is " + sum);
```

**Don't Do It**  
The `sum` variable is not recognized here.

## TWO TRUTHS & A LIE

### Using Multiple Statements in an `if` or `if...else` Structure

1. To execute more than one statement that depends on the evaluation of a Boolean expression, you use a pair of curly braces to place the dependent statements within a block.
2. Indentation can be used to cause statements following an `if` statement to depend on the evaluation of the Boolean expression.
3. When you declare a variable within a block, it is local to that block.

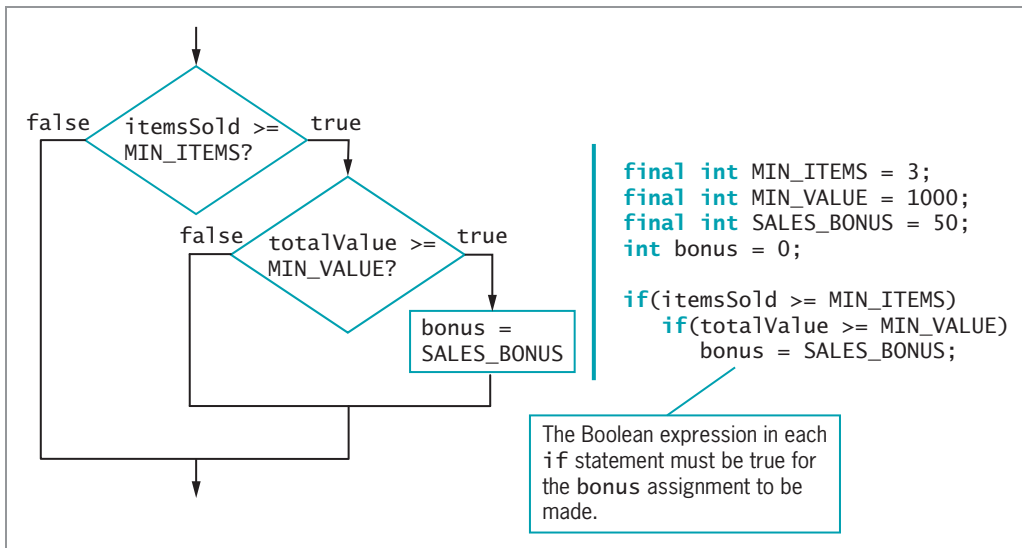
The false statement is #2. Indentation does not cause statements following an `if` statement to be dependent; curly braces are required if multiple statements must be treated as a block.

## Nesting `if` and `if...else` Statements

Within an `if` or an `else`, you can code as many dependent statements as you need, including other `if` and `else` structures. Statements in which an `if` structure is contained inside another `if` structure are commonly called **nested `if` statements**. Nested `if` statements are particularly useful when two conditions must be met before some action is taken.

For example, suppose you want to pay a \$50 bonus to a salesperson only if the salesperson sells at least three items that total at least \$1,000 in value during a specified time. Figure 5-10 shows the logic and the code to solve the problem.

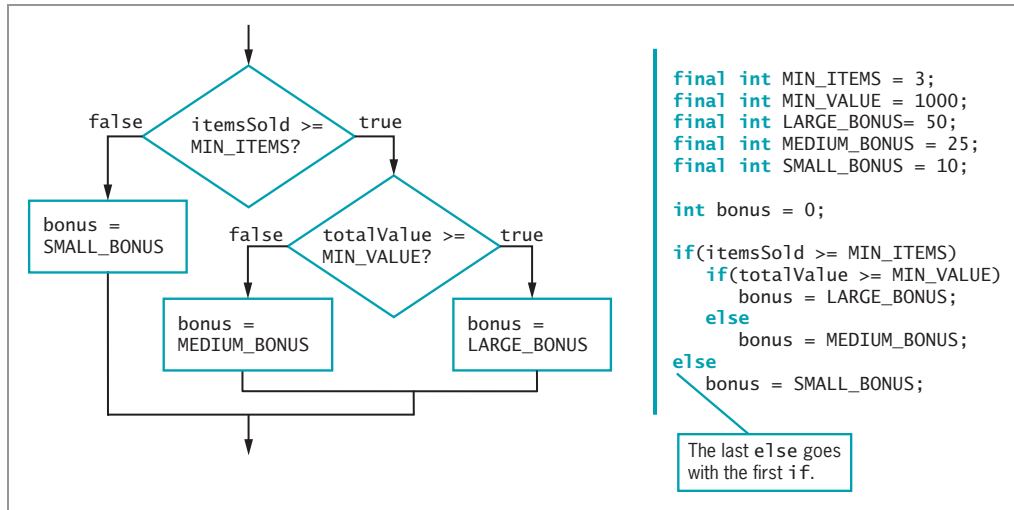




**Figure 5-10** Determining whether to assign a bonus using nested if statements

Notice there are no semicolons in the if statement code shown in Figure 5-10 until after the `bonus = SALES_BONUS;` statement. The expression `itemsSold >= MIN_ITEMS` is evaluated first. Only if this expression is true does the program evaluate the second Boolean expression, `totalValue >= MIN_VALUE`. If that expression is also true, the bonus assignment statement executes, and the if structure ends.

When you use nested if statements, you must pay careful attention to placement of any `else` clauses. For example, suppose you want to distribute bonuses on a revised schedule, as shown in Figure 5-11. If the salesperson does not sell at least three items, you want to give a \$10 bonus. If the salesperson sells at least three items whose combined value is less than \$1,000, the bonus is \$25. If the salesperson sells at least three items whose combined value is at least \$1,000, the bonus is \$50.



**Figure 5-11** Determining one of three bonuses using nested `if` statements

As Figure 5-11 shows, when one `if` statement follows another, the first `else` clause encountered is paired with the most recent `if` encountered. In this figure, the complete nested `if...else` structure fits entirely within the `if` portion of the outer `if...else` statement. No matter how many levels of `if...else` statements are needed to produce a solution, the `else` statements are always associated with their `ifs` on a “first in-last out” basis. In Figure 5-11, the indentation of the lines of code helps to show which `else` is paired with which `if`. Remember, the compiler does not take indentation into account, but consistent indentation can help readers understand a program’s logic.

## TWO TRUTHS & A LIE

### Nesting `if` and `if...else` Statements

1. Statements in which an `if` structure is contained inside another `if` structure commonly are called nested `if` statements.
2. When one `if` statement follows another, the first `else` clause encountered is paired with the first `if` that occurred before it.
3. A complete nested `if...else` structure always fits entirely within either the `if` portion or the `else` portion of its outer `if...else` statement.

The false statement is #2. When one `if` statement follows another, the first `else` clause encountered is paired with the most recent `if` encountered.

## Using Logical AND and OR Operators

For an alternative to some nested `if` statements, you can use the **logical AND operator** between two Boolean expressions to determine whether both are `true`. In Java, the AND operator is written as two ampersands ( `&&` ). For example, the two statements shown in Figure 5-12 work exactly the same way. In each case, both the `itemsSold` variable must be at least the minimum number of items required for a bonus and the `totalValue` variable must be at least the minimum required value for the bonus to be set to `SALES_BONUS`.

```
if(itemsSold >= MIN_ITEMS)
    if(totalValue >= MIN_VALUE)
        bonus = SALES_BONUS;

if(itemsSold >= MIN_ITEMS && totalValue >= MIN_VALUE)
    bonus = SALES_BONUS;
```

**Figure 5-12** Code for bonus-determining decision using nested `ifs` and using the `&&` operator

It is important to note that when you use the `&&` operator, you must include a complete Boolean expression on each side. If you want to set a bonus to \$400 when a `saleAmount` is both over \$1,000 and under \$5,000, the correct statement is:

```
if(saleAmount > 1000 && saleAmount < 5000)
    bonus = 400;
```



In Chapter 2 you learned that the arithmetic operators are binary operators because they require operands on each side of the operator. The `&&` operator is also a binary operator.



For clarity, many programmers prefer to surround each Boolean expression that is part of a compound Boolean expression with its own set of parentheses. For example:

```
if((saleAmount > 1000) && (saleAmount < 5000))
    bonus = 400;
```

Use this format if it is clearer to you.

Even though the `saleAmount` variable is intended to be used in both parts of the AND expression, the following statement is incorrect and does not compile because there is not a complete expression on both sides of the `&&`:

```
if(saleAmount > 1000 && < 5000)
    bonus = 400;
```

**Don't Do It**

This statement will not compile because it does not have a Boolean expression on each side of the `&&`.

The expressions on each side of the `&&` operator are evaluated only as far as necessary to determine whether the entire expression is `true` or `false`. This feature is called **short-circuit evaluation**. With the `&&` operator, both Boolean expressions must be `true` before the action in the result statement can occur. (The same is true for nested `ifs`, as you can see in Figure 5-10.) If the first tested expression is `false`, the second expression is never evaluated, because its value does not matter. For example, if `a` is not greater than `LIMIT` in the following `if` statement, then the evaluation is complete because there is no need to evaluate whether `b` is greater than `LIMIT`.

```
if(a > LIMIT && b > LIMIT)
    System.out.println("Both are greater than " + LIMIT);
```

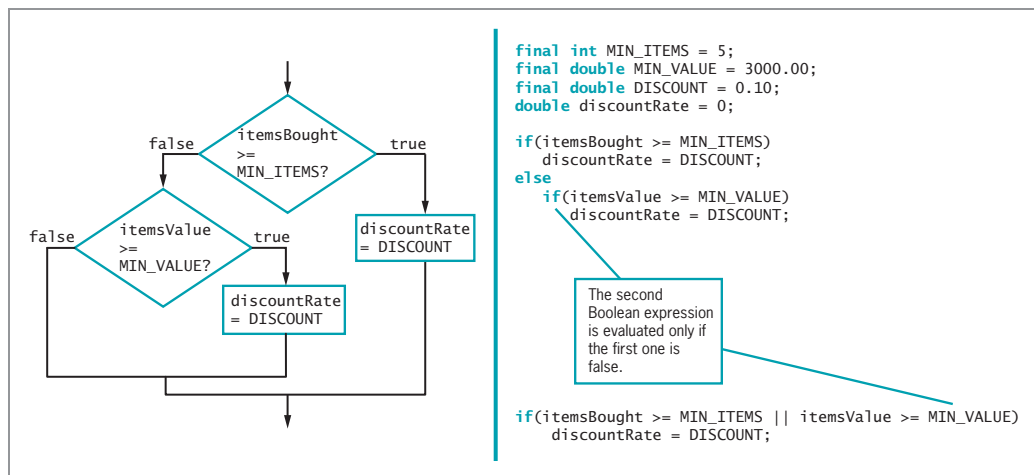
You are never required to use the `&&` operator because using nested `if` statements always achieves the same result, but using the `&&` operator often makes your code more concise, less error-prone, and easier to understand.

When you want some action to occur even if only one of two conditions is `true`, you can use nested `if` statements, or you can use the **conditional OR operator**, which is written as `||`.

For example, if you want to give a 10% discount to any customer who satisfies at least one of two conditions—buying at least five items or buying any number of items that total at least \$3,000 in value—you can write the code using either of the ways shown in Figure 5-13.



The two vertical lines used in the OR operator are sometimes called “pipes.” The pipe appears on the same key as the backslash on your keyboard.



**Figure 5-13** Determining customer discount when customer needs to meet only one of two criteria

As with the `&&` operator, the `||` operator uses short-circuit evaluation. In other words, because only one of the Boolean expressions in an `||` expression must be true to cause the dependent statements to execute, if the expression to the left of the `||` is true, then there is no need to evaluate the expression to the right of the `||`.



A common use of the `||` operator is to decide to take action whether a character variable is either the uppercase or lowercase version of a letter. For example, in the following statement, the subsequent action occurs whether the `selection` variable holds an uppercase or lowercase A:

```
if(selection == 'A' || selection == 'a')
    System.out.println("You chose option A");
```



Watch the video *Using && and ||*.

## TWO TRUTHS & A LIE

### Using Logical AND and OR Operators

1. The AND operator is written as two ampersands ( `&&` ) and the OR operator is written as two pipes ( `||` ).
2. When you use the `&&` and `||` operators, you must include a complete Boolean expression on each side.
3. When you use an `&&` or `||` operator, each Boolean expression that surrounds the operator is always tested in order from left to right.

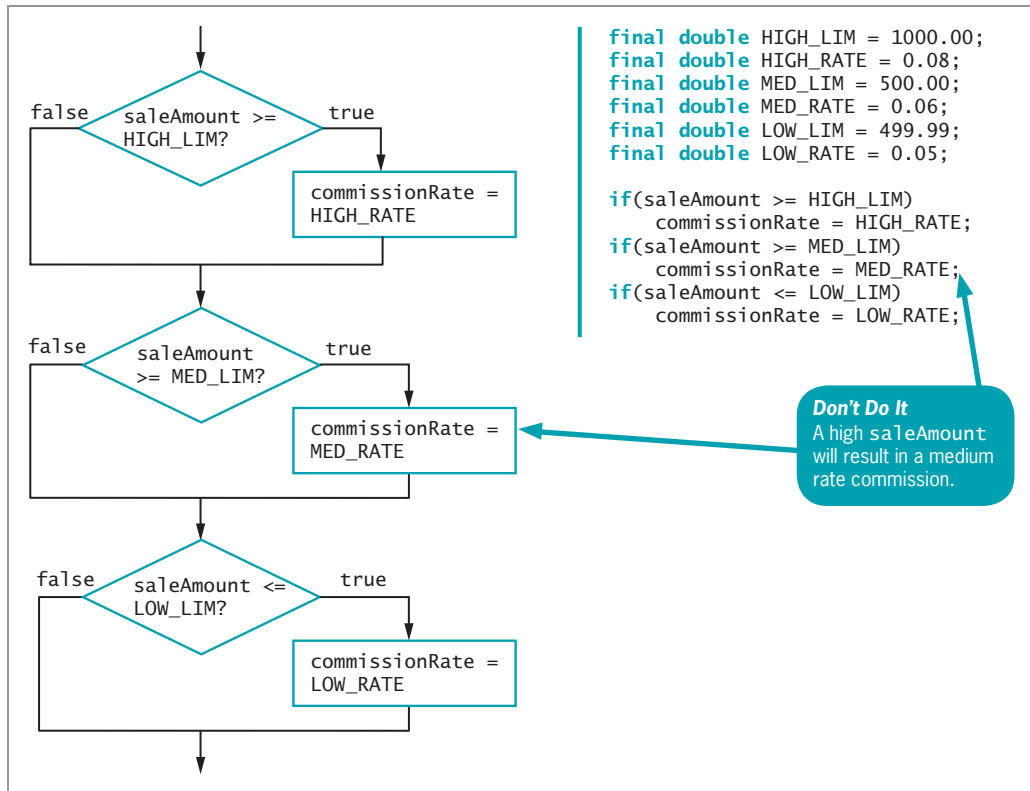
The false statement is #3. The expressions in each part of an AND or OR expression are evaluated only as much as necessary to determine whether the entire expression is true or false. For example, in an AND expression, if the first Boolean value is false, the second expression is not tested. In an OR expression, if the first Boolean value is true, the second expression is not tested. This feature is called short-circuit evaluation.

## Making Accurate and Efficient Decisions

When new programmers must make a range check, they often introduce incorrect or inefficient code into their programs. A **range check** is a series of statements that determine within which of a set of ranges a value falls. Consider a situation in which salespeople can receive one of three possible commission rates based on their sales. For example, a sale totaling \$1,000 or more earns the salesperson an 8% commission, a sale totaling \$500 through \$999 earns 6% of the sale amount, and any sale totaling \$499.99 or

less earns 5%. Using three separate `if` statements to test single Boolean expressions might result in some incorrect commission assignments. For example, examine the code shown in Figure 5-14.

228



**Figure 5-14** Incorrect commission-determining code

Using the code shown in Figure 5-14, when a `saleAmount` is \$5,000, for example, the first `if` statement executes, and the Boolean expression `(saleAmount >= HIGH_LIM)` evaluates as `true`, so `HIGH_RATE` is correctly assigned to `commissionRate`. However, when a `saleAmount` is \$5,000, the next `if` expression, `(saleAmount >= MED_LIM)`, also evaluates as `true`, so the `commissionRate`, which was just set to `HIGH_RATE`, is incorrectly reset to `MED_RATE`.

A partial solution to this problem is to use an `else` statement following the first evaluation, as shown in Figure 5-15.

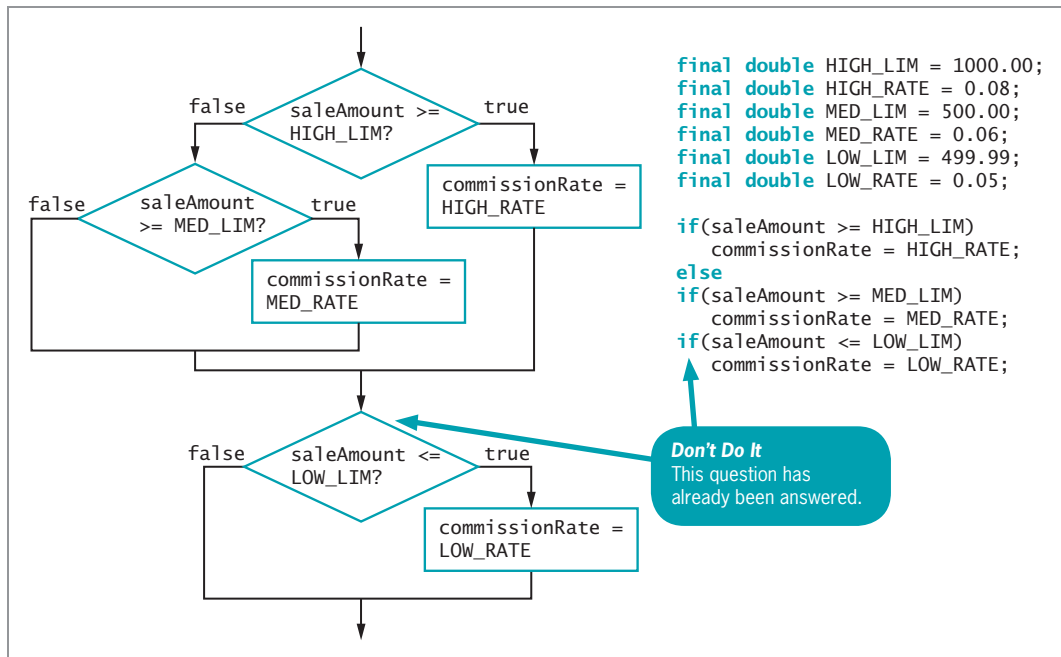
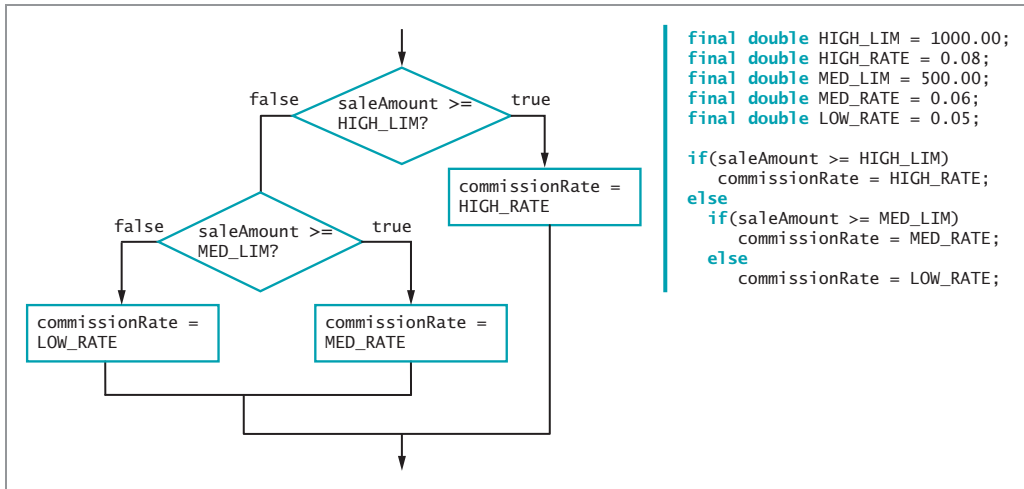


Figure 5-15 Improved, but inefficient, commission-determining code

With the new code in Figure 5-15, when the `saleAmount` is \$5,000, the expression `(saleAmount >= HIGH_LIM)` is true and the `commissionRate` becomes `HIGH_RATE`; then the entire if structure ends. When the `saleAmount` is not greater than or equal to \$1,000 (for example, \$800), the first if expression is false, and the else statement executes and correctly sets the `commissionRate` to `MED_RATE`.

The code shown in Figure 5-15 works, but it is somewhat inefficient. When the `saleAmount` is any amount over `LOW_LIM`, either the first if sets `commissionRate` to `HIGH_RATE` for amounts that are at least \$1,000, or its else sets `commissionRate` to `MED_RATE` for amounts that are at least \$500. In either of these two cases, the Boolean value tested in the next statement, `if (saleAmount <= LOW_LIM)`, is always false, so `commissionRate` is set correctly. However, it was unnecessary to ask the `LOW_LIM` question.

After you know that `saleAmount` is not at least `MED_LIM`, rather than asking `if(saleAmount <= LOW_LIM)`, it's easier, more efficient, and less error prone to use an else. If the `saleAmount` is not at least `HIGH_LIM` and is also not at least `MED_LIM`, it must by default be less than or equal to `LOW_LIM`. Figure 5-16 shows this improved logic.

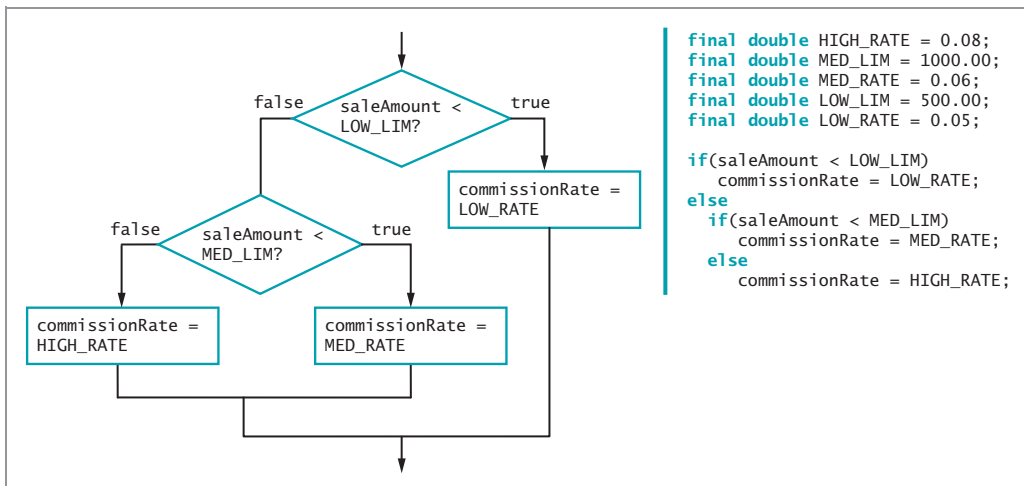


**Figure 5-16** Improved and efficient commission-determining logic



In the code in Figure 5-16, the `LOW_LIM` constant is no longer declared because it is not used.

Within a nested `if...else`, like the one shown in Figure 5-16, it is most efficient to ask the question that is most likely to be true first. In other words, if you know that most `saleAmount` values are high, compare `saleAmount` to `HIGH_LIM` first. That way, you most frequently avoid asking multiple questions. If, however, you know that most `saleAmount`s are small, you should ask `if(saleAmount < LOW_LIM)` first. The code shown in Figure 5-17 results in the



**Figure 5-17** Commission-determining code asking about smallest `saleAmount` first



same commission value for any given `saleAmount`, but is more efficient when most `saleAmount` values are small.



In Figure 5-17, notice that the comparisons use the `<` operator instead of `<=`. That's because a `saleAmount` of \$1,000.00 should result in a `HIGH_RATE`, and a `saleAmount` of \$500.00 should result in a `MED_RATE`. If you wanted to use `<=` comparisons, then you could change the `MED_LIM` and `LOW_LIM` cutoff values to 999.99 and 499.99, respectively.

## Using `&&` and `||` Appropriately

Beginning programmers often use the `&&` operator when they mean to use `||`, and often use `||` when they should use `&&`. Part of the problem lies in the way we use the English language. For example, your boss might request, “Display an error message when an employee’s hourly pay rate is under \$5.85 and when an employee’s hourly pay rate is over \$60.” You define \$5.85 as a named constant `LOW` and \$60 as `HIGH`. However, because your boss used the word *and* in the request, you might be tempted to write a program statement like the following:

```
if(payRate < LOW && payRate > HIGH)
    System.out.println("Error in pay rate");
```

**Don't Do It**  
This message can never be output.

However, as a single variable, no `payRate` value can ever be both below 5.85 *and* over 60 at the same time, so the output statement can never execute, no matter what value the `payRate` has. In this case, you must write the following code to display the error message under the correct circumstances:

```
if(payRate < LOW || payRate > HIGH)
    System.out.println("Error in pay rate");
```

Similarly, your boss might request, “Display the names of those employees in departments 1 and 2.” Because the boss used the word *and* in the request, you might be tempted to write the following:

```
if(department == 1 && department == 2)
    System.out.println("Name is: " + name);
```

**Don't Do It**  
This message can never be output.

However, the variable `department` can never contain both a 1 and a 2 at the same time, so no employee name will ever be output, no matter what department the employee is in.



Another type of mistake occurs if you use a single ampersand or pipe when you try to indicate a logical AND or OR. Both `&` and `|` are valid Java operators, but they have two different functions. When you use a single `&` or `|` with integers, it operates on bits. When you use a single `&` or `|` with Boolean expressions, it always evaluates both expressions instead of using short-circuitry.

## TWO TRUTHS & A LIE

### Making Accurate and Efficient Decisions

1. A range check is a series of statements that determine within which of a set of ranges a value falls.
2. When you must make a series of decisions in a program, it is most efficient to first ask the question that is most likely to be true.
3. The statement `if(payRate < 6.00 && payRate > 50.00)` can be used to select `payRate` values that are higher or lower than the specified limits.

The false statement is #3. The statement `if(payRate > 6.00 && payRate < 50.00)` cannot be used to make a selection because no value for `payRate` can be both below 6.00 and above 50.00 at the same time.

## Using the `switch` Statement

By nesting a series of `if` and `else` statements, you can choose from any number of alternatives. For example, suppose you want to display a student's class year based on a stored number. Figure 5-18 shows one possible implementation of the program.

```
if(year == 1)
    System.out.println("Freshman");
else
    if(year == 2)
        System.out.println("Sophomore");
    else
        if(year == 3)
            System.out.println("Junior");
        else
            if(year == 4)
                System.out.println("Senior");
            else
                System.out.println("Invalid year");
```

**Figure 5-18** Determining class status using nested `if` statements

An alternative to using the series of nested `if` statements shown in Figure 5-18 is to use the `switch` statement. The **switch statement** is useful when you need to test a single variable against a series of exact integer (including `int`, `byte`, and `short` types), character, or string values. The `switch` structure uses four keywords:

- `switch` starts the structure and is followed immediately by a test expression enclosed in parentheses.
- `case` is followed by one of the possible values for the test expression and a colon.
- `break` optionally terminates a `switch` structure at the end of each case.
- `default` optionally is used prior to any action that should occur if the test variable does not match any case.

Figure 5-19 shows the `switch` structure used to display the four school years.

```
int year;
// Get year value from user input, or simply by assigning
switch(year)
{
    case 1:
        System.out.println("Freshman");
        break;
    case 2:
        System.out.println("Sophomore");
        break;
    case 3:
        System.out.println("Junior");
        break;
    case 4:
        System.out.println("Senior");
        break;
    default:
        System.out.println("Invalid year");
}
```

**Figure 5-19** Determining class status using a `switch` statement



You are not required to list the `case` values in ascending order, as shown in Figure 5-19, although doing so often makes a statement easier to understand. Logically, it is most efficient to list the most common case first, instead of the case with the lowest value.

The `switch` structure shown in Figure 5-19 begins by evaluating the `year` variable shown in the `switch` statement. If the year is equal to the first case value, which is 1, the statement that displays “Freshman” executes. The `break` statement bypasses the rest of the `switch` structure, and execution continues with any statement after the closing curly brace of the `switch` structure.

If the `year` variable is not equivalent to the first case value of 1, the next case value is compared, and so on. If the `year` variable does not contain the same value as any of the case statements, the `default` statement or statements execute.

You can leave out the `break` statements in a `switch` structure. However, if you omit the `break` and the program finds a match for the test variable, all the statements within the `switch` statement execute from that point forward. For example, if you omit each `break` statement in the code shown in Figure 5-19, when the year is 3, the first two cases are bypassed, but *Junior*,

*Senior*, and *Invalid year* all are output. You should intentionally omit the `break` statements if you want all subsequent cases to execute after the test variable is matched.

You do not need to write code for each case in a `switch` statement. For example, suppose that the supervisor for departments 1, 2, and 3 is *Jones*, but other departments have different supervisors. In that case, you might use the code in Figure 5-20.

234

```
int department;
String supervisor;
// Statements to get department go here
switch(department)
{
    case 1:
    case 2:
    case 3:
        supervisor = "Jones";
        break;
    case 4:
        supervisor = "Staples";
        break;
    case 5:
        supervisor = "Tejano";
        break;
    default:
        System.out.println("Invalid department code");
}
```

**Figure 5-20** Using empty case statements

On the other hand, you might use strings in a `switch` structure to determine whether a supervisor name is valid, as shown in the method in Figure 5-21.

```
public static boolean isValidSupervisor(string name)
{
    boolean isValid;
    switch(name)
    {
        case "Jones":
        case "Staples":
        case "Tejano":
            isValid = true;
            break;
        default:
            isValid = false;
    }
    return isValid;
}
```

**Figure 5-21** A method that uses a `switch` structure with string values



The ability to use strings as the tested values in a `switch` statement is a new feature in Java 7.

When several `char` variables must be checked and you want to ignore whether they are uppercase or lowercase, one frequently used technique employs empty case statements, as in Figure 5-22.

```
switch(departmentCode)
{
    case 'a':
    case 'A':
        departmentName = "Accounting";
        break;
    case 'm':
    case 'M':
        departmentName = "Marketing";
        break;
    // and so on
}
```

**Figure 5-22** Using a `switch` structure to ignore character case

You are never required to use a `switch` structure; you can always achieve the same results with nested `if` statements. The `switch` structure is simply convenient to use when there are several alternative courses of action that depend on a single integer, character, or string value. In addition, it makes sense to use `switch` only when a reasonable number of specific matching values need to be tested.



Watch the video *Using the `switch` Statement*.

## TWO TRUTHS & A LIE

### Using the switch Statement

1. When you must make more decisions than Java can support, you use a `switch` statement instead of nested `if...else` statements.
2. The `switch` statement is useful when you need to test a single variable against a series of exact integer or character values.
3. A `break` statement bypasses the rest of its `switch` structure, and execution continues with any statement after the closing curly brace of the `switch` structure.

The false statement is #1. By nesting a series of `if` and `else` statements, you can choose from any number of alternatives. The `switch` statement is just a more convenient way of expressing nested `if...else` statements when the tested value is an integer or character.

## Using the Conditional and NOT Operators

Besides using `if` statements and `switch` structures, Java provides one more way to make decisions. The **conditional operator** requires three expressions separated with a question mark and a colon, and is used as an abbreviated version of the `if...else` structure. As with the `switch` structure, you are never required to use the conditional operator; it is simply a convenient shortcut. The syntax of the conditional operator is:

```
testExpression ? trueResult : falseResult;
```

The first expression, `testExpression`, is a Boolean expression that is evaluated as `true` or `false`. If it is `true`, the entire conditional expression takes on the value of the expression following the question mark (`trueResult`). If the value of the `testExpression` is `false`, the entire expression takes on the value of `falseResult`.



You have seen many examples of binary operators such as `==` and `&&`. The conditional operator is a **ternary operator**—one that needs three operands. Through Java 6, the conditional operator is the only ternary operator in Java, so it is sometimes referred to as “the” ternary operator.



Java 7 introduces a collapsed version of the ternary operator that checks for `null` values assigned to objects. The new operator is called *the Elvis operator* because it uses a question mark and colon together (`? :`); if you view it sideways, it reminds you of Elvis Presley.

For example, suppose you want to assign the smallest price to a sale item. Let the variable `a` be the advertised price and the variable `b` be the discounted price on the sale tag. The expression for assigning the smallest cost is:

```
smallerNum = (a < b) ? a : b;
```

When evaluating the expression `a < b`, where `a` is less than `b`, the entire conditional expression takes the value of `a`, which then is assigned to `smallerNum`. If `a` is not less than `b`, the expression assumes the value of `b`, and `b` is assigned to `smallerNum`.

You could achieve the same results with the following `if...else` structure:

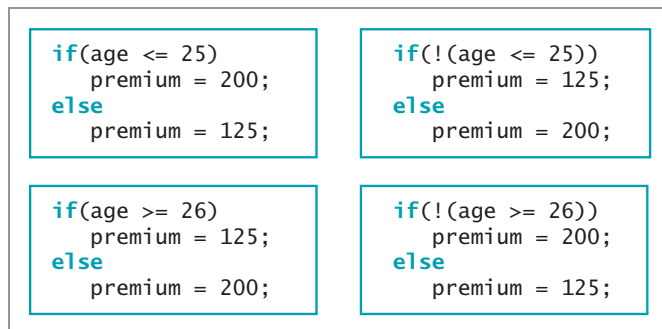
```
if(a < b)
    smallerNum = a;
else
    smallerNum = b;
```

The advantage of using the conditional operator is the conciseness of the statement.

## Using the NOT Operator

You use the **NOT operator**, which is written as the exclamation point (`!`), to negate the result of any Boolean expression. Any expression that evaluates as `true` becomes `false` when preceded by the NOT operator, and accordingly, any `false` expression preceded by the NOT operator becomes `true`.

For example, suppose a monthly car insurance premium is \$200 if the driver is age 25 or younger and \$125 if the driver is age 26 or older. Each of the `if...else` statements in Figure 5-23 correctly assigns the premium values.



**Figure 5-23** Four `if...else` statements that all do the same thing

In Figure 5-23, the statements with the `!` operator are somewhat harder to read, particularly because they require the double set of parentheses, but the result of the decision-making process is the same in each case. Using the `!` operator is clearer when the value of a Boolean variable is tested. For example, a variable initialized as `boolean oldEnough = (age >= 25);` can become part of the relatively easy-to-read expression `if(!oldEnough)...`

## TWO TRUTHS & A LIE

### Using the Conditional and NOT Operators

1. The conditional operator is used as an abbreviated version of the `if...else` structure and requires two expressions separated with an exclamation point.
2. The NOT operator is written as the exclamation point ( `!` ).
3. The value of any false expression becomes true when preceded by the NOT operator.

The false statement is #1. The conditional operator requires three expressions separated with a question mark and a colon.

## Understanding Operator Precedence

You can combine as many `&&` or `||` operators as you need to make a decision. For example, if you want to award bonus points (defined as `BONUS`) to any student who receives a perfect score on any of four quizzes, you might write a statement like the following:

```
if(score1 == PERFECT || score2 == PERFECT ||
   score3 == PERFECT || score4 == PERFECT)
    bonus = BONUS;
else
    bonus = 0;
```

In this case, if at least one of the score variables is equal to the `PERFECT` constant, the student receives the bonus points.

Although you can combine any number of `&&` or `||` operators, special care must be taken when you combine them. You learned in Chapter 2 that operations have higher and lower precedences, and an operator's precedence makes a difference in how an expression is evaluated. For example, within an arithmetic expression, multiplication and division are always performed prior to addition or subtraction. Table 5-1 shows the precedence of the operators you have used so far.

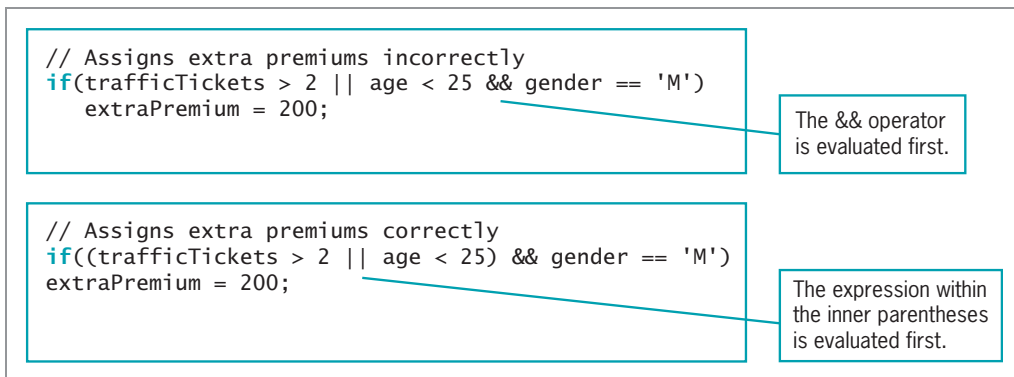


| Precedence   | Operator(s)                       | Symbol(s) |
|--------------|-----------------------------------|-----------|
| Highest      | Logical NOT                       | !         |
| Intermediate | Multiplication, division, modulus | * / %     |
|              | Addition, subtraction             | + -       |
|              | Relational                        | > < >= <= |
|              | Equality                          | == !=     |
|              | Logical AND                       | &&        |
|              | Logical OR                        |           |
|              | Conditional                       | ?:        |
| Lowest       | Assignment                        | =         |

**Table 5-1** Operator precedence for operators used so far

In general, the order of precedence agrees with common algebraic usage. For example, in any mathematical expression, such as  $x = a + b$ , the arithmetic is done first and the assignment is done last, as you would expect. The relationship of `&&` and `||` might not be as obvious. The `&&` operator has higher precedence than the `||` operator. For example, consider the program segments shown in Figure 5-24. These code segments are intended to be part of an insurance company program that determines whether an additional premium should be charged to a driver who meets both of the following criteria:

- Has more than two traffic tickets or is under 25 years old
- Is male



**Figure 5-24** Two comparisons using `&&` and `||`



You can remember the precedence of the AND and OR operators by remembering that they are evaluated in alphabetical order.

Consider a 30-year-old female driver with three traffic tickets; according to the stated criteria, she should not be assigned the extra premium because she is not male. With the first `if` statement in Figure 5-24, the `&&` operator takes precedence, so `age < 25 && gender == 'M'` is evaluated first. The value is `false` because `age` is not less than 25, so the expression is reduced to `trafficTickets > 2` or `false`. Because the value of the `tickets` variable is greater than 2, the entire expression is `true`, and \$200 is assigned to `extraPremium`, even though it should not be.

In the second `if` statement shown in Figure 5-24, parentheses have been added so the `||` operator is evaluated first. The expression `trafficTickets > 2 || age < 25` is `true` because the value of `trafficTickets` is 3. So the expression evolves to `true && gender == 'M'`. Because `gender` is not 'M', the value of the entire expression is `false`, and the `extraPremium` value is not assigned 200, which is correct.



Using parentheses to make your intentions more clear is never wrong. Even when an expression would be evaluated in the desired way without extra parentheses, adding them can help others to more easily understand your programs.

The following two conventions are important to keep in mind:

- The order in which you use operators makes a difference.
- You can always use parentheses to change precedence or make your intentions clearer.

## TWO TRUTHS & A LIE

### Understanding Operator Precedence

1. Assume `p`, `q`, and `r` are all Boolean variables that have been assigned the value `true`. After the following statement executes, the value of `p` is still `true`.

```
p = !q || r;
```

2. Assume `p`, `q`, and `r` are all Boolean variables that have been assigned the value `true`. After the following statement executes, the value of `p` is still `true`.

```
p = !(!q && !r);
```

3. Assume `p`, `q`, and `r` are all Boolean variables that have been assigned the value `true`. After the following statement executes, the value of `p` is still `true`.

```
p = !(q || !r);
```

The false statement is #3. If `p`, `q`, and `r` are all Boolean variables that have been assigned the value `true`, then after `p = !(q || !r);` executes, the value of `p` is `false`. First `q` is evaluated as `true`, so the entire expression within the parentheses is `true`. The leading `NOT` operator reverses that result to `false` and assigns it to `p`.

## You Do It

### Using an `if...else`

In this section, you will start writing a program for a party planning company. The program determines which employee to assign to manage a client's event. To begin, you will prompt the user to answer a question about the event type, and then the program will display the name of the manager who handles such events. There are two event types: private events, handled by Dustin Britt, and corporate events, handled by Carmen Lindsey.

#### To write a program that chooses between two managers:

1. Open a new text file, and then enter the first lines of code to create a class named `ChooseManager`. You will import the `Scanner` class so that you can use keyboard input. The class will contain a `main()` method that performs all the work of the class:

```
import java.util.Scanner;
public class ChooseManager
{
    public static void main(String[] args)
    {
```

2. On new lines, declare the variables and constants this application will use. You will ask the user to enter an integer `eventType`. The values of the event types and the names of the managers for private and corporate events are stored as symbolic constants; the chosen manager will be assigned to the `chosenManager` string:

```
int eventType;
String chosenManager;
final int PRIVATE_CODE = 1;
final int CORPORATE_CODE = 2;
final String PRIV_MANAGER = "Dustin Britt";
final String CORP_MANAGER = "Carmen Lindsey";
```

3. Define the input device, then add the code that prompts the user to enter a `1` or `2` depending on the event type being scheduled, and accept the response:

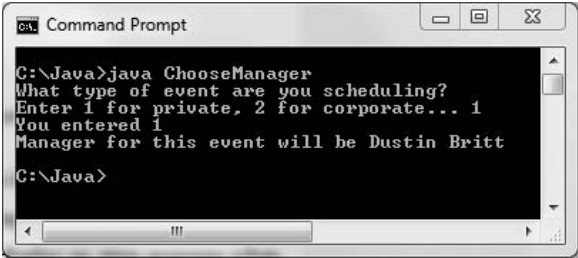
```
Scanner input = new Scanner(System.in);
System.out.println("What type of event are you scheduling?");
System.out.print("Enter " + PRIVATE_CODE + " for private, " +
    CORPORATE_CODE + " for corporate ... ");
eventType = input.nextInt();
```

4. Use an `if...else` statement to choose the name of the manager to be assigned to the `chosenManager` string, as follows:

```
if(eventType == PRIVATE_CODE)
    chosenManager = PRIV_MANAGER;
else
    chosenManager = CORP_MANAGER;
```

5. Display the chosen code and corresponding manager's name:  

```
System.out.println("You entered " + eventType);  
System.out.println("Manager for this event will be " +  
    chosenManager);
```
6. Type the two closing curly braces to end the `main()` method and the `ChooseManager` class.
7. Save the program as **ChooseManager.java**, and then compile and run the program. Confirm that the program selects the correct manager when you choose *1* for a private event or *2* for a corporate event. For example, Figure 5-25 shows the output when the user enters *1* for a private event.



```
Command Prompt  
C:\Java>java ChooseManager  
What type of event are you scheduling?  
Enter 1 for private, 2 for corporate... 1  
You entered 1  
Manager for this event will be Dustin Britt  
C:\Java>
```

**Figure 5-25** Output of the `ChooseManager` application after user enters *1*

8. Rerun the `ChooseManager` program and enter an invalid item, such as *3*. The manager selected is Carmen Lindsey because the program tests only for an entered value of *1* or not *1*. Modify the program to display an error message when the entered value is not *1* or *2*. Rename the class **ChooseManager2**, and save the file as **ChooseManager2.java**.

## Creating an Event Class to Use in a Decision-Making Application

Next, you will create an `Event` class. The class will be used to store data about a planned event. Each `Event` object includes three data fields: the type of event, the name of the manager for the event, and the hourly rate charged for handling the event. The `Event` class also contains a `get` and `set` method for each field.

### To create the `Event` class:

1. Open a new text file and type the class header for the `Event` class, followed by declarations for the three data fields:

```
public class Event  
{  
    private int typeOfEvent;  
    private double rate;  
    private String manager;
```

2. Create three get methods; each returns one of the data fields in the Event class:

```
public int getType()
{
    return typeOfEvent;
}
public double getRate()
{
    return rate;
}
public String getManager()
{
    return manager;
}
```

3. Also add three set methods; each sets a single data field:

```
public void setType(int eventType)
{
    typeOfEvent = eventType;
}
public void setRate(double eventRate)
{
    rate = eventRate;
}
public void setManager(String managerName)
{
    manager = managerName;
}
```

4. Type the closing curly brace for the class.
5. Save the file as **Event.java**, then compile the file and correct any errors.

## Writing an Application that Uses the Event class

Now that you have created an Event class, you will create a CreateEventObject application. You will prompt the user for an event type, and then select both a manager and a rate for the Event based on the selected type. Private events are managed by Dustin Britt and cost \$47.99 per hour. Corporate events are managed by Carmen Lindsey and cost \$75.99 per hour. Events held by nonprofit organizations are managed by Robin Armenetti and cost \$40.99 per hour. After the user selects an event type, you will instantiate an Event object containing appropriate event data.

### To create an application that uses the Event class:

1. Open a new file in your text editor, and type the following to begin the CreateEventObject class:

```
import java.util.Scanner;
public class CreateEventObject
{
    public static void main(String[] args)
    {
```

2. Add variables and constants that will be used in the program as follows:

```
int eventType;  
String chosenManager = "";  
double chosenRate = 0;  
Event scheduledEvent = new Event();  
final int PRIVATE_CODE = 1;  
final int CORPORATE_CODE = 2;  
final int NONPROFIT_CODE = 3;  
final String PRIVATE_MANAGER = "Dustin Britt";  
final String CORP_MANAGER = "Carmen Lindsey";  
final String NONPROFIT_MANAGER = "Robin Armenetti";  
final double PRIVATE_RATE = 47.99;  
final double CORP_RATE = 75.99;  
final double NONPROFIT_RATE = 40.99;  
boolean choiceIsGood = true;
```

3. Declare a Scanner object to be used for input, prompt the user for an event type, and read it in:

```
Scanner input = new Scanner(System.in);  
System.out.println("What type of event are you scheduling?");  
System.out.print("Enter " + PRIVATE_CODE + " for private, " +  
    CORPORATE_CODE + " for corporate, or " + NONPROFIT_CODE +  
    " for nonprofit... ");  
eventType = input.nextInt();
```

4. Write a decision that selects the correct manager and rate based on the user's choice. Because two statements execute when the user selects 1, 2, or 3, the statements must be blocked using curly braces. If the user does not enter 1, 2, or 3, set the Boolean variable choiceIsGood to false:

```
if(eventType == PRIVATE_CODE)  
{  
    chosenManager = PRIVATE_MANAGER;  
    chosenRate = PRIVATE_RATE;  
}  
else  
    if(eventType == CORPORATE_CODE)  
    {  
        chosenManager = CORP_MANAGER;  
        chosenRate = CORP_RATE;  
    }  
else  
    if(eventType == NONPROFIT_CODE)  
    {  
        chosenManager = NONPROFIT_MANAGER;  
        chosenRate = NONPROFIT_RATE;  
    }  
else  
    choiceIsGood = false;
```

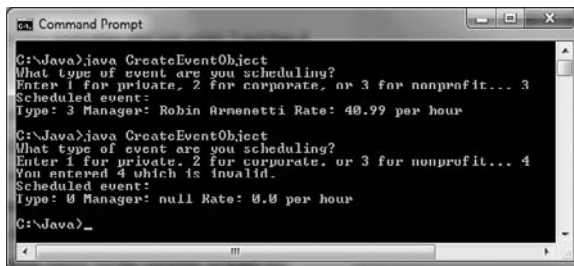
5. If the user made a valid choice, set values for the three fields that are contained in the scheduled Event object. Otherwise, display an error message:

```
if(choiceIsGood)
{
    scheduledEvent.setType(eventType);
    scheduledEvent.setManager(chosenManager);
    scheduledEvent.setRate(chosenRate);
}
else
    System.out.println("You entered " + eventType +
        " which is invalid.");
```

6. To confirm that the Event was created properly, display the Event object's fields:

```
System.out.println("Scheduled event:");
System.out.println("Type: " + scheduledEvent.getType() +
    " Manager: " + scheduledEvent.getManager() + " Rate: " +
    scheduledEvent.getRate() + " per hour");
```

7. Add a closing curly brace for the main() method and another for the class.
8. Save the application as **CreateEventObject.java**. Compile and run the program several times with different input at the prompt. Confirm that the output shows the correct event manager, type, and rate based on your response to the prompt. (If your response is an invalid event type, then the default values for the event should appear.) Figure 5-26 shows two executions of the program.



```
C:\Java>java CreateEventObject
What type of event are you scheduling?
Enter 1 for private, 2 for corporate, or 3 for nonprofit... 3
Scheduled event:
Type: 3 Manager: Robin Arnenetti Rate: 40.99 per hour

C:\Java>java CreateEventObject
What type of event are you scheduling?
Enter 1 for private, 2 for corporate, or 3 for nonprofit... 4
You entered 4 which is invalid.
Scheduled event:
Type: 0 Manager: null Rate: 0.0 per hour

C:\Java>_
```

**Figure 5-26** Output of the CreateEventObject application after user enters 3 and then 4

9. Experiment with the program by removing the initialization values for chosenManager and chosenRate. When you compile the program, you receive error messages for the setManager() and setRate() statements that chosenManager and chosenRate might not have been initialized. The compiler determines that the values for those variables are set based on if statements, and so, depending on the outcome, they might never have been given valid values. Replace the initialization values for the variables to make the program compile successfully.
10. Experiment with the program by removing the initialization value for the Boolean variable choiceIsGood. When you compile the program, you receive an error message that the variable might never have been initialized. Because the variable is set to false

only under certain conditions (an invalid event type entry), the compiler determines that the variable might not have a usable value. Replace the initialization value and recompile the program to make it work correctly.

## Using the `switch` Statement

246

Next, you will modify the `CreateEventObject` program to convert the nested `if` statements to a `switch` structure.

### To convert the `CreateEventObject` decision-making process to a `switch` structure:

1. If necessary, open the `CreateEventObject.java` file, and change the class name to **`CreateEventObjectSwitch`**. Immediately save the file as **`CreateEventObjectSwitch.java`**.
2. Delete the `if...else` statements that currently determine which number the user entered, and then replace them with the following `switch` structure:

```
switch(eventType)
{
    case PRIVATE_CODE:
        chosenManager = PRIVATE_MANAGER;
        chosenRate = PRIVATE_RATE;
        break;
    case CORPORATE_CODE:
        chosenManager = CORP_MANAGER;
        chosenRate = CORP_RATE;
        break;
    case NONPROFIT_CODE:
        chosenManager = NONPROFIT_MANAGER;
        chosenRate = NONPROFIT_RATE;
        break;
    default:
        choiceIsGood = false;
}
```

3. Save the file, compile, and test the application. Make certain the correct output appears when you enter *1*, *2*, *3*, or any invalid number as keyboard input.

## Don't Do It

- Don't ignore subtleties in boundaries used in decision making. For example, selecting employees who make less than \$20 an hour is different from selecting employees who make \$20 an hour or less.
- Don't use the assignment operator instead of the comparison operator when testing for equality.
- Don't insert a semicolon after the Boolean expression in an `if` statement; insert the semicolon after the entire statement is completed.
- Don't forget to block a set of statements with curly braces when several statements depend on the `if` or the `else` statement.
- Don't forget to include a complete Boolean expression on each side of an `&&` or `||` operator.



- Don't try to use a `switch` structure to test anything other than an integer, character, or `String` value.
- Don't forget a `break` statement if one is required by the logic of your `switch` structure.
- Don't use the standard relational operators to compare objects; use them only with the built-in Java types. In the chapter *Characters, Strings, and the `StringBuilder`*, you will learn how to compare `Strings` correctly, and in the chapter *Advanced Inheritance Concepts*, you will learn to compare other objects.

## Key Terms

**Pseudocode** is a tool that helps programmers plan a program's logic by writing plain English statements.

A **flowchart** is a tool that helps programmers plan a program's logic by writing the steps in diagram form, as a series of shapes connected by arrows.

A **sequence structure** is a logical structure in which one step follows another unconditionally.

A **decision structure** is a logical structure that involves choosing between alternative courses of action based on some value within a program.

True or false values are **Boolean values**; every computer decision results in a Boolean value.

In Java, the simplest statement you can use to make a decision is the **if statement**; you use it to write a single-alternative decision.

The **equivalency operator** ( `==` ) compares values and returns `true` if they are equal.

An **empty statement** contains only a semicolon.

A **single-alternative if** is a decision structure that performs an action, or not, based on one alternative.

A **dual-alternative if** is a decision structure that takes one of two possible courses of action.

In Java, the **if...else statement** provides the mechanism to perform one action when a Boolean expression evaluates as `true` and to perform a different action when a Boolean expression evaluates as `false`.

A **nested if statement** contains an `if` structure within another `if` structure.

You can use the **logical AND operator** between Boolean expressions to determine whether both are `true`. The AND operator is written as two ampersands ( `&&` ).

**Short-circuit evaluation** describes the feature of the AND and OR operators in which evaluation is performed only as far as necessary to make a final decision.

You can use the **conditional OR operator** between Boolean expressions to determine whether either expression is `true`. The OR operator is written as two pipes ( `||` ).

A **range check** is a series of statements that determine within which of a set of ranges a value falls.

The **switch statement** uses up to four keywords to test a single variable against a series of exact integer or character values. The keywords are `switch`, `case`, `break`, and `default`.

The **conditional operator** requires three expressions separated with a question mark and a colon, and is used as an abbreviated version of the `if...else` structure.

A **ternary operator** is one that needs three operands.

You use the **NOT operator**, which is written as the exclamation point (`!`), to negate the result of any Boolean expression.

## Chapter Summary

- Making a decision involves choosing between two alternative courses of action based on some value within a program.
- You can use the `if` statement to make a decision based on a Boolean expression that evaluates as `true` or `false`. If the Boolean expression enclosed in parentheses within an `if` statement is `true`, the subsequent statement or block executes. A single-alternative `if` performs an action based on one alternative; a dual-alternative `if`, or `if...else`, provides the mechanism for performing one action when a Boolean expression is `true` and a different action when the expression is `false`.
- To execute more than one statement that depends on the evaluation of a Boolean expression, you use a pair of curly braces to place the dependent statements within a block. Within an `if` or an `else` statement, you can code as many dependent statements as you need, including other `if` and `else` statements.
- Nested `if` statements are particularly useful when two conditions must be met before some action occurs.
- You can use the AND operator (`&&`) within a Boolean expression to determine whether two expressions are both `true`. You use the OR operator (`||`) when you want to carry out some action even if only one of two conditions is `true`.
- New programmers frequently cause errors in their `if` statements when they perform a range check incorrectly or inefficiently, or when they use the wrong operator with AND and OR.
- You use the `switch` statement to test a single variable against a series of exact integer or character values.
- The conditional operator requires three expressions, a question mark, and a colon, and is used as an abbreviated version of the `if...else` statement. You use the NOT operator (`!`) to negate the result of any Boolean expression.
- Operator precedence makes a difference in how expressions are evaluated. You can always use parentheses to change precedence or make your intentions clearer.

## Review Questions

- The logical structure in which one instruction occurs after another with no branching is a \_\_\_\_\_.
  - sequence
  - selection
  - loop
  - case
- Which of the following is typically used in a flowchart to indicate a decision?
  - square
  - rectangle
  - diamond
  - oval
- Which of the following is not a type of `if` statement?
  - single-alternative `if`
  - dual-alternative `if`
  - reverse `if`
  - nested `if`
- A decision is based on a(n) \_\_\_\_\_ value.
  - Boolean
  - absolute
  - definitive
  - convoluted
- In Java, the value of  $(4 > 7)$  is \_\_\_\_\_.
  - 4
  - 7
  - `true`
  - `false`
- Assuming the variable `q` has been assigned the value 3, which of the following statements displays XXX?
  - `if(q > 0) System.out.println("XXX");`
  - `if(q > 7); System.out.println("XXX");`
  - Both of the above statements display XXX.
  - Neither of the above statements displays XXX.
- What is the output of the following code segment?

```
t = 10;
if(t > 7)
{
    System.out.print("AAA");
    System.out.print("BBB");
}
```

  - AAA
  - BBB
  - AAABBB
  - nothing
- What is the output of the following code segment?

```
t = 10;
if(t > 7)
```

```
System.out.print("AAA");
System.out.print("BBB");
```

- a. AAA
- b. BBB
- c. AAABBB
- d. nothing

9. What is the output of the following code segment?

```
t = 7;
if(t > 7)
    System.out.print("AAA");
    System.out.print("BBB");
```

- a. AAA
- b. BBB
- c. AAABBB
- d. nothing

10. When you code an `if` statement within another `if` statement, as in the following, then the `if` statements are \_\_\_\_\_.

```
if(a > b)
    if(c > d)x = 0;
```

- a. notched
- b. nestled
- c. nested
- d. sheltered

11. The operator that combines two conditions into a single Boolean value that is `true` only when both of the conditions are `true`, but is `false` otherwise, is \_\_\_\_\_.

- a. \$\$
- b. !!
- c. ||
- d. &&

12. The operator that combines two conditions into a single Boolean value that is `true` when at least one of the conditions is `true` is \_\_\_\_\_.

- a. \$\$
- b. !!
- c. ||
- d. &&

13. Assuming a variable `f` has been initialized to 5, which of the following statements sets `g` to 0?

- a. `if(f > 6 || f == 5) g = 0;`
- b. `if(f < 3 || f > 4) g = 0;`
- c. `if(f >= 0 || f < 2) g = 0;`
- d. All of the above statements set `g` to 0.

14. Which of the following groups has the lowest operator precedence?

- a. relational
- b. equality
- c. addition
- d. logical OR

15. Which of the following statements correctly outputs the names of voters who live in district 6 and all voters who live in district 7?

- a. `if(district == 6 || 7)
 System.out.println("Name is " + name);`

- b. `if(district == 6 || district == 7)  
System.out.println("Name is " + name);`
- c. `if(district = 6 && district == 7)  
System.out.println("Name is " + name);`
- d. two of these
16. Which of the following displays "Error" when a student ID is less than 1000 or more than 9999?
- a. `if(stuId < 1000) if(stuId > 9999)  
System.out.println("Error");`
- b. `if(stuId < 1000 && stuId > 9999)  
System.out.println("Error");`
- c. `if(stuId < 1000)  
System.out.println("Error");  
else if(stuId > 9999)  
System.out.println("Error");`
- d. two of these
17. You can use the \_\_\_\_\_ statement to terminate a switch structure.
- a. switch  
b. end  
c. case  
d. break
18. The argument within a switch structure can be any of the following *except* a(n) \_\_\_\_\_.
- a. int  
b. char  
c. double  
d. String
19. Assuming a variable w has been assigned the value 15, what does the following statement do?
- `w == 15 ? x = 2 : x = 0;`
- a. assigns 15 to w  
b. assigns 2 to x  
c. assigns 0 to x  
d. nothing
20. Assuming a variable y has been assigned the value 6, the value of `!(y < 7)` is \_\_\_\_\_.
- a. 6  
b. 7  
c. true  
d. false

## Exercises

1.
  - a. Write an application that prompts the user for a checking account balance and a savings account balance. Display the message “Checking account balance is low” if the checking account balance is less than \$10. Display the message “Savings account balance is low” if the savings account balance is less than \$100. Save the file as **Balance.java**.
  - b. Modify the application in Exercise 1a to display an additional message, “Both accounts are dangerously low”, if both fall below the specified limits. Save the file as **Balance2.java**.
2.
  - a. Write an application for a furniture company; the program determines the price of a table. Ask the user to choose 1 for pine, 2 for oak, or 3 for mahogany. The output is the name of the wood chosen as well as the price of the table. Pine tables cost \$100, oak tables cost \$225, and mahogany tables cost \$310. If the user enters an invalid wood code, set the price to 0. Save the file as **Furniture.java**.
  - b. Add a prompt to the application you wrote in Exercise 2a to ask the user to specify a (1) large table or a (2) small table, but only if the wood selection is valid. Add \$35 to the price of any large table, and add nothing to the price for a small table. Display an appropriate message if the size value is invalid, and assume the price is for a small table. Save the file as **Furniture2.java**.
3.
  - a. Write an application for a college’s admissions office. Prompt the user for a student’s numeric high school grade point average (for example, 3.2) and an admission test score from 0 to 100. Display the message “Accept” if the student has any of the following:
    - ♦ A grade point average of 3.0 or above and an admission test score of at least 60
    - ♦ A grade point average below 3.0 and an admission test score of at least 80If the student does not meet either of the qualification criteria, display “Reject”. Save the file as **Admission.java**.
  - b. Modify the application in Exercise 3a so that if a user enters a grade point average under 0 or over 4.0, or a test score under 0 or over 100, an error message appears instead of the “Accept” or “Reject” message. Save the file as **Admission2.java**.
4. Create a class named `CheckingAccount` with data fields for an account number and a balance. Include a constructor that takes arguments for each field. The constructor sets the balance to 0 if it is below the required \$200.00 minimum for an account. Also include a method that displays account details, including an explanation if the balance was reduced to 0. Write an application named `TestAccount` in which you instantiate two `CheckingAccount` objects, prompt the user for values for the account number and balance, and display the values of both accounts. Save both the **CheckingAccount.java** and **TestAccount.java** files.

5. a. Write an application that prompts an employee for an hourly pay rate and hours worked. Compute gross pay (hours times rate), withholding tax, and net pay (gross pay minus withholding tax). Withholding tax is computed as a percentage of gross pay based on the following:

| Gross Pay (\$)             | Withholding (%) |
|----------------------------|-----------------|
| Up to and including 300.00 | 10              |
| 300.01 and up              | 12              |

Save the file as **ComputeNet.java**.

- b. Modify the application you created in Exercise 5a using the following withholding percentage ranges:

| Gross Pay (\$)   | Withholding (%) |
|------------------|-----------------|
| 0 to 300.00      | 10              |
| 300.01 to 400.00 | 12              |
| 400.01 to 500.00 | 15              |
| 500.01 and over  | 20              |

Save the file as **ComputeNet2.java**.

6. Write an application that prompts the user for two integers and then prompts the user to enter an option as follows: *1* to add the two integers, *2* to subtract the second integer from the first, *3* to multiply the integers, and *4* to divide the first integer by the second. Display an error message if the user enters an option other than *1* through *4* or if the user chooses the divide option but enters *0* for the second integer. Otherwise, display the results of the arithmetic. Save the file as **Calculate.java**.
7. a. Write an application for a lawn-mowing service. The lawn-mowing season lasts 20 weeks. The weekly fee for mowing a lot under 4,000 square feet is \$25. The fee for a lot that is 4,000 square feet or more, but under 6,000 square feet, is \$35 per week. The fee for a lot that is 6,000 square feet or over is \$50 per week. Prompt the user for the length and width of a lawn, and then display the weekly mowing fee, as well as the 20-week seasonal fee. Save the file as **Lawn.java**.
- b. To the Lawn application you created in Exercise 7a, add a prompt that asks the user whether the customer wants to pay (1) once, (2) twice, or (3) 20 times per year.

If the user enters *1* for once, the fee for the season is simply the seasonal total. If the customer requests two payments, each payment is half the seasonal fee plus a \$5 service charge. If the user requests 20 separate payments, add a \$3 service charge per week. Display the number of payments the customer must make, each payment amount, and the total for the season. Save the file as **Lawn2.java**.

8. Write an application that recommends a pet for a user based on the user's lifestyle. Prompt the user to enter whether he or she lives in an apartment, house, or dormitory (1, 2, or 3) and the number of hours the user is home during the average day. The user will select an hour category from a menu: (1) 18 or more; (2) 10 to 17; (3) 8 to 9; (4) 6 to 7; or (5) 0 to 5. Output your recommendation based on the following table:

| Residence | Hours Home    | Recommendation  |
|-----------|---------------|-----------------|
| House     | 18 or more    | Pot-bellied pig |
| House     | 10 to 17      | Dog             |
| House     | Fewer than 10 | Snake           |
| Apartment | 10 or more    | Cat             |
| Apartment | Fewer than 10 | Hamster         |
| Dormitory | 6 or more     | Fish            |
| Dormitory | Fewer than 6  | Ant farm        |

Save the file as **PetAdvice.java**.

9. a. Write an application that displays a menu of three items in a restaurant as follows:

|                  |      |
|------------------|------|
| (1) Cheeseburger | 4.99 |
| (2) Pepsi        | 2.00 |
| (3) Chips        | 0.75 |

Prompt the user to choose an item using the number (1, 2, or 3) that corresponds to the item, or to enter *0* to quit the application. After the user makes the first selection, if the choice is *0*, display a bill of \$0. Otherwise, display the menu again. The user should respond to this prompt with another item number to order or *0* to quit. If the user types *0*, display the cost of the single requested item. If the user types *1*, *2*, or *3*, add the cost of the second item to the first, and then display the menu a third time. If the user types *0* to quit, display the total cost of the two items; otherwise, display the total for all three selections. Save the file as **FastFood.java**.



- b. Modify the application in Exercise 9a so that if the user makes a menu selection he or she has already made, ignore the selection—that is, do not add a second price for the same item to the total. The user still is allowed only three entries. Save the file as **FastFood2.java**.
10. a. Create a class named `Invoice` that holds an invoice number, balance due, and three fields representing the month, day, and year that the balance is due. Create a constructor that accepts values for all five data fields. Within the constructor, assign each argument to the appropriate field with the following exceptions:
- ♦ If an invoice number is less than 1000, force the invoice number to 0.
  - ♦ If the month field is less than 1 or greater than 12, force the month field to 0.
  - ♦ If the day field is less than 1 or greater than 31, force the day field to 0.
  - ♦ If the year field is less than 2011 or greater than 2017, force the year field to 0.
- In the `Invoice` class, include a display method that displays all the fields on an `Invoice` object. Save the file as **Invoice.java**.
- b. Write an application containing a `main()` method that declares several `Invoice` objects, proving that all the statements in the constructor operate as specified. Save the file as **TestInvoice.java**.
- c. Modify the constructor in the `Invoice` class so that the day is not greater than 31, 30, or 28, depending on the month. For example, if a user tries to create an invoice for April 31, force it to April 30. Also, if the month is invalid, and thus forced to 0, also force the day to 0. Save the modified `Invoice` class as **Invoice2.java**. Then modify the `TestInvoice` class to create `Invoice2` objects. Create enough objects to test every decision in the constructor. Save this file as **TestInvoice2.java**.
11. Use the Web to locate the lyrics to the traditional song “The Twelve Days of Christmas.” The song contains a list of gifts received for the holiday. The list is cumulative so that as each “day” passes, a new verse contains all the words of the previous verse, plus a new item. Write an application that displays the words to the song starting with any day the user enters. (*Hint*: Use a `switch` statement with cases in descending day order and without any `break` statements so that the lyrics for any day repeat all the lyrics for previous days.) Save the file as **TwelveDays.java**.
12. Barnhill Fastener Company runs a small factory. The company employs workers who are paid one of three hourly rates depending on skill level:

| Skill Level | Hourly Pay Rate (\$) |
|-------------|----------------------|
| 1           | 17.00                |
| 2           | 20.00                |
| 3           | 22.00                |

Each factory worker might work any number of hours per week; any hours over 40 are paid at one and one-half times the usual rate.

In addition, workers in skill levels 2 and 3 can elect the following insurance options:

| Option | Explanation                    | Weekly Cost to Employee (\$) |
|--------|--------------------------------|------------------------------|
| 1      | Medical insurance              | 32.50                        |
| 2      | Dental insurance               | 20.00                        |
| 3      | Long-term disability insurance | 10.00                        |

Also, workers in skill level 3 can elect to participate in the retirement plan at 3% of their gross pay.

Write an interactive Java payroll application that calculates the net pay for a factory worker. The program prompts the user for skill level and hours worked, as well as appropriate insurance and retirement options for the employee's skill level category. The application displays: (1) the hours worked, (2) the hourly pay rate, (3) the regular pay for 40 hours, (4) the overtime pay, (5) the total of regular and overtime pay, and (6) the total itemized deductions. If the deductions exceed the gross pay, display an error message; otherwise, calculate and display (7) the net pay after all the deductions have been subtracted from the gross. Save the file as **Pay.java**.



### Debugging Exercise

13. Each of the following files in the Chapter.05 folder of your downloadable student files has syntax and/or logic errors. In each case, determine the problem and fix the program. After you correct the errors, save each file using the same filename preceded with Fix. For example, save `DebugFive1.java` as `FixDebugFive1.java`.
  - a. `DebugFive1.java`
  - b. `DebugFive2.java`
  - c. `DebugFive3.java`
  - d. `DebugFive4.java`



### Game Zone

14. In Chapter 1, you created a class called `RandomGuess`. In this game, players guess a number, the application generates a random number, and players determine whether they were correct. Now that you can make decisions, modify the application so it allows a player to enter a guess before the random number is displayed, and then displays a message indicating whether the player's guess was correct, too high, or too low. Save the file as **RandomGuess2.java**. (After you finish the next chapter, you will be able to modify the application so that the user can continue to guess until the correct answer is entered.)

15. Create a lottery game application. Generate three random numbers (see Appendix D for help in doing so), each between 0 and 9. Allow the user to guess three numbers. Compare each of the user's guesses to the three random numbers and display a message that includes the user's guess, the randomly determined three-digit number, and the amount of money the user has won as follows:

| Matching Numbers              | Award (\$) |
|-------------------------------|------------|
| Any one matching              | 10         |
| Two matching                  | 100        |
| Three matching, not in order  | 1,000      |
| Three matching in exact order | 1,000,000  |
| No matches                    | 0          |

Make certain that your application accommodates repeating digits. For example, if a user guesses 1, 2, and 3, and the randomly generated digits are 1, 1, and 1, do not give the user credit for three correct guesses—just one. Save the file as **Lottery.java**.

16. In Chapter 3, you created a `Card` class. Modify the `Card` class so the `setValue()` method does not allow a `Card`'s value to be less than 1 or higher than 13. If the argument to `setValue()` is out of range, assign 1 to the `Card`'s value.

In Chapter 3, you also created a `PickTwoCards` application that randomly selects two playing cards and displays their values. In that application, all `Card` objects were arbitrarily assigned a suit represented by a single character, but they could have different values, and the player observed which of two `Card` objects had the higher value. Now, modify the application so the suit and the value both are chosen randomly. Using two `Card` objects, play a very simple version of the card game `War`. Deal two `Cards`—one for the computer and one for the player—and determine the higher card, then display a message indicating whether the cards are equal, the computer won, or the player won. (Playing cards are considered equal when they have the same value, no matter what their suit is.) For this game, assume the `Ace` (value 1) is low. Make sure that the two `Cards` dealt are not the same `Card`. For example, a deck cannot contain more than one `Card` representing the 2 of spades. If two cards are chosen to have the same value, change the suit for one of them. Save the application as **War.java**. (After you study the chapter *Arrays*, you will be able to create a more sophisticated `War` game in which you use an entire deck without repeating cards.)

17. In Chapter 4, you created a `Die` class from which you could instantiate an object containing a random value from 1 through 6. You also wrote an application that randomly “throws” two dice and displays their values. Modify the application so it determines whether the two dice are the same, the first has a higher value, or the second has a higher value. Save the application as **TwoDice2.java**.

18. In the game Rock Paper Scissors, two players simultaneously choose one of three options: rock, paper, or scissors. If both players choose the same option, then the result is a tie. However, if they choose differently, the winner is determined as follows:
- ♦ Rock beats scissors, because a rock can break a pair of scissors.
  - ♦ Scissors beats paper, because scissors can cut paper.
  - ♦ Paper beats rock, because a piece of paper can cover a rock.

Create a game in which the computer randomly chooses rock, paper, or scissors. Let the user enter a number 1, 2, or 3, each representing one of the three choices. Then, determine the winner. Save the application as **RockPaperScissors.java**. (In the chapter *Characters, Strings, and the StringBuilder*, you will modify the game so that the user enters a string for *rock*, *paper*, and *scissors*, rather than just entering a number.)

# Looping

In this chapter, you will:

- ③ Learn about the loop structure
- ③ Create `while` loops
- ③ Use shortcut arithmetic operators
- ③ Create `for` loops
- ③ Create `do...while` loops
- ③ Nest loops
- ③ Improve loop performance

## Learning About the Loop Structure

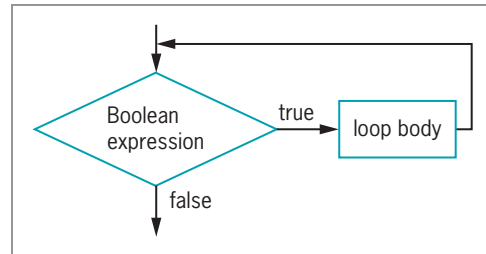
If making decisions is what makes programs seem smart, looping is what makes programs seem powerful. A **loop** is a structure that allows repeated execution of a block of statements. Within a looping structure, a Boolean expression is evaluated. If it is `true`, a block of statements called the **loop body** executes and the Boolean expression is evaluated again. As long as the expression is `true`, the statements in the loop body continue to execute. When the Boolean evaluation is `false`, the loop ends. One execution of any loop is called an **iteration**. Figure 6-1 shows a diagram of the logic of a loop.



Recall that a block of statements might be a single statement without curly braces, or one or more statements within curly braces.

In Java, you can use several mechanisms to create loops. In this chapter, you will learn to use three types of loops:

- A `while` loop, in which the loop-controlling Boolean expression is the first statement in the loop
- A `for` loop, which is usually used as a concise format in which to execute loops
- A `do...while` loop, in which the loop-controlling Boolean expression is the last statement in the loop



**Figure 6-1** Flowchart of a loop structure

### TWO TRUTHS & A LIE

#### Learning About the Loop Structure

1. A loop is a structure that allows repeated execution of a block of statements as long as a tested expression is `true`.
2. If a loop's tested Boolean expression is `true`, a block of statements called the loop body executes before the Boolean expression is evaluated again.
3. When the Boolean evaluation tested in a loop becomes `false`, the loop body executes one last time.

The false statement is #3. When the Boolean evaluation tested in a loop is `false`, the loop ends.

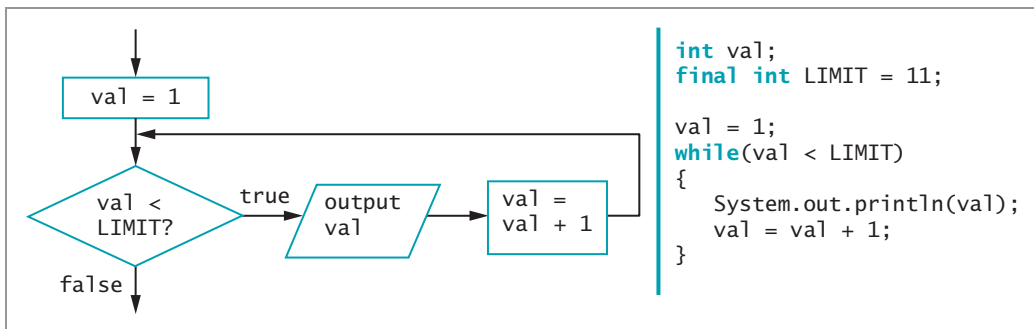
## Creating while Loops

You can use a **while loop** to execute a body of statements continually as long as the Boolean expression that controls entry into the loop continues to be `true`. In Java, a while loop consists of the keyword `while` followed by a Boolean expression within parentheses, followed by the body of the loop, which can be a single statement or a block of statements surrounded by curly braces.

You can use a while loop when you need to perform a task a predetermined number of times. A loop that executes a specific number of times is a **definite loop** or a counted loop. On the other hand, the number of times the loop executes might not be determined until the program is running. Such a loop is an **indefinite loop** because you don't know how many times it will eventually loop.

### Writing a Definite while Loop

To write a definite loop, you initialize a **loop control variable**, a variable whose value determines whether loop execution continues. While the Boolean value that results from comparing the loop control variable and another value is `true`, the body of the while loop continues to execute. In the body of the loop, you must include a statement that alters the loop control variable. For example, the program segment shown in Figure 6-2 displays the series of integers 1 through 10. The variable `val` is the loop control variable—it starts the loop holding a value of 1, and while the value remains under 11, `val` continues to be output and increased.

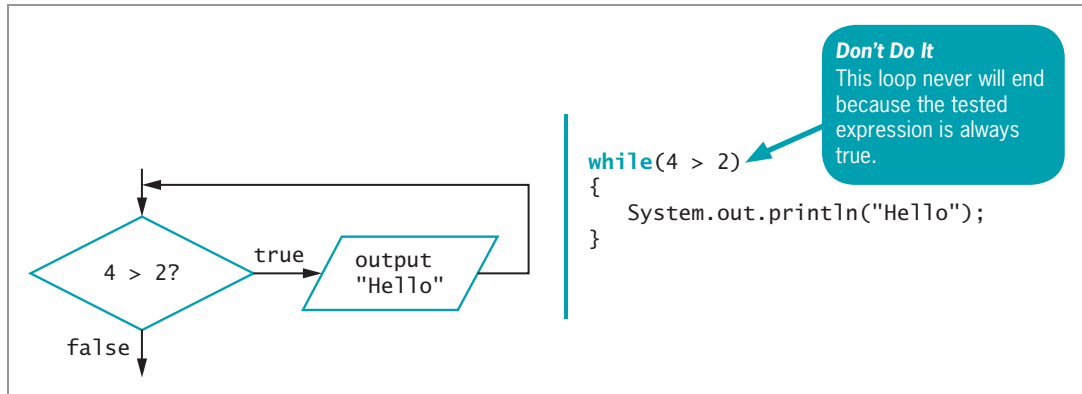


**Figure 6-2** A while loop that displays the integers 1 through 10



To an algebra student, a statement such as `val = val + 1;` looks wrong—a value can never be one more than itself. In algebra, the equal sign means equivalency. In Java, however, the equal sign assigns a value to the variable on the left. Therefore, `val = val + 1;` takes the value of `val`, adds 1 to it, and then assigns the new value back into `val`.

When you write applications containing loops, it is easy to make mistakes. For example, executing the code shown in Figure 6-3 causes the message “Hello” to display (theoretically) forever because there is no code to end the loop. A loop that never ends is called an **infinite loop**.



**Figure 6-3** A loop that displays “Hello” infinitely



An infinite loop might not actually execute infinitely. Depending on the tasks the loop performs, eventually the computer memory might be exhausted (literally and figuratively) and execution might stop. Also, it's possible that the processor has a time-out feature that forces the loop to end. Either way, and depending on your system, quite a bit of time could pass before the loop stops running.



As an inside joke to programmers, the address of Apple Computer, Inc. is One Infinite Loop, Cupertino, California.

In Figure 6-3, the expression  $4 > 2$  evaluates to `true`. You obviously never need to make such an evaluation, but if you do so in this `while` loop, the body of the loop is entered and “Hello” is displayed. Next, the expression is evaluated again. The expression  $4 > 2$  is still `true`, so the body is entered again. “Hello” is displayed repeatedly; the loop never finishes because  $4 > 2$  is never `false`.

It is a bad idea to intentionally write an infinite loop. However, even experienced programmers write them by accident. So, before you start writing loops, it is good to know how to exit from an infinite loop in the event you find yourself in the midst of one. You might suspect an infinite loop if the same output is displayed repeatedly, or if the screen simply remains idle for an extended period of time without displaying expected output. If you think your application is in an infinite loop, you can press and hold `Ctrl`, and then press `C` or `Break`; the looping program should terminate. (On many keyboards, the `Break` key is also the `Pause` key.)

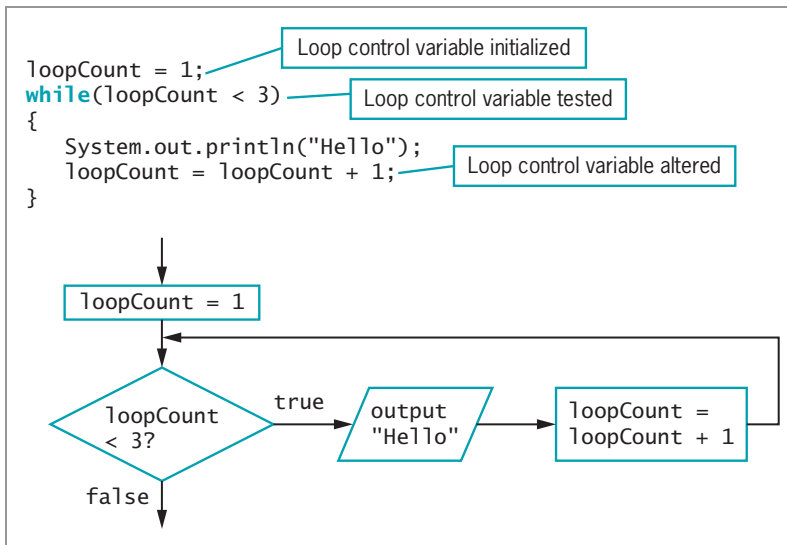
To prevent a `while` loop from executing infinitely, three separate actions must occur:

- A named loop control variable is initialized to a starting value.
- The loop control variable is tested in the `while` statement.



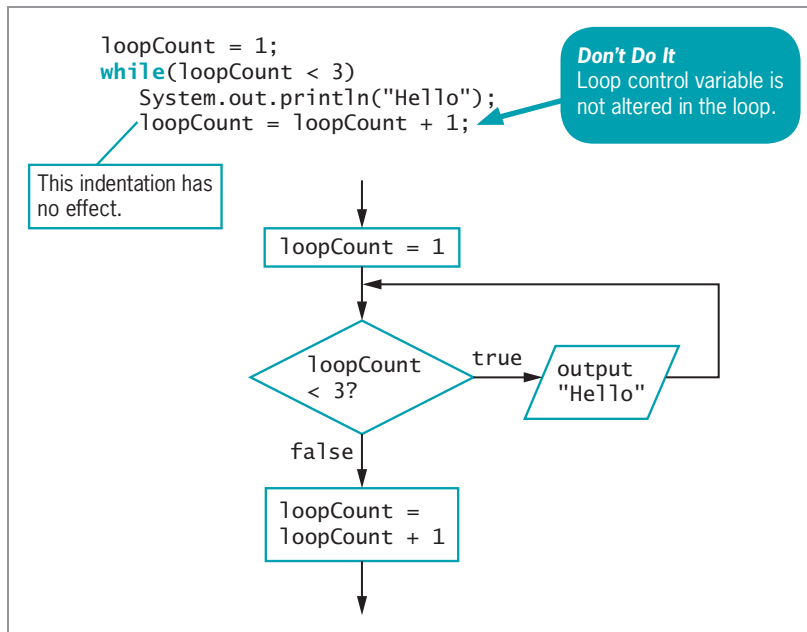
- If the test expression is `true`, the body of the `while` statement must take some action that alters the value of the loop control variable; the test of the `while` statement must eventually evaluate to `false` so that the loop can end.

All of these conditions are met by the example in Figure 6-4. First, a loop control variable `loopCount` is named and set to a value of 1. Second, the statement `while (loopCount < 3)` is tested. Third, the loop body is executed because the loop control variable `loopCount` is less than 3. Note that the loop body shown in Figure 6-4 consists of two statements made into a block by their surrounding curly braces. The first statement displays “Hello,” and then the second statement adds 1 to `loopCount`. The next time `loopCount` is evaluated, it is 2. It is still less than 3, so the loop body executes again. “Hello” is displayed a second time, and `loopCount` becomes 3. Finally, because the expression `loopCount < 3` now evaluates to `false`, the loop ends. Program execution then continues with any subsequent statements.



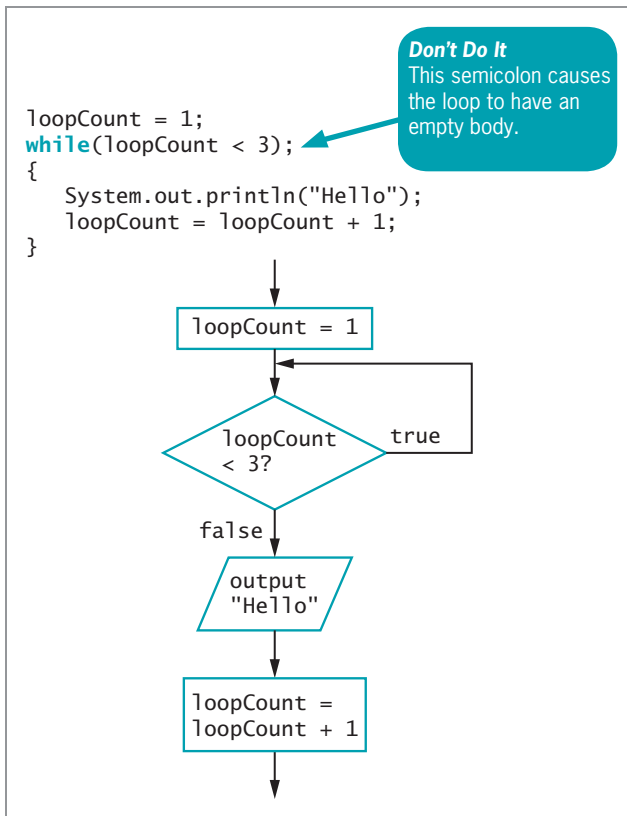
**Figure 6-4** A `while` loop that displays “Hello” twice

It is important that the loop control variable be altered within the body of the loop. Figure 6-5 shows the same code as in Figure 6-4, but the curly braces have been eliminated. In this case, the `while` loop body ends at the semicolon that appears at the end of the “Hello” statement. Adding 1 to the `loopCount` is no longer part of a block that contains the loop, so the value of `loopCount` never changes, and an infinite loop is created.



**Figure 6-5** A `while` loop that displays “Hello” infinitely because `loopCount` is not altered in the loop body

As with the decision-making `if` statement that you learned about in Chapter 5, placement of the statement-ending semicolon is important when you work with the `while` statement. If a semicolon is mistakenly placed at the end of the partial statement `while (loopCount < 3);`, as shown in Figure 6-6, the loop is also infinite. This loop has an **empty body**, or a body with no statements in it. So, the Boolean expression is evaluated, and because it is `true`, the loop body is entered. Because the loop body is empty, no action is taken, and the Boolean expression is evaluated again. Nothing has changed, so it is still `true`, the empty body is entered, and the infinite loop continues.



**Figure 6-6** A while loop that loops infinitely with no output because the loop body is empty

It is very common to alter the value of a loop control variable by adding 1 to it, or **incrementing** the variable. However, not all loops are controlled by adding 1. The loop shown in Figure 6-7 displays “Hello” twice, just as the loop in Figure 6-4 does, but its loop is controlled by subtracting 1 from a loop control variable, or **decrementing** it.

```

loopCount = 3;
while(loopCount > 1)
{
    System.out.println("Hello");
    loopCount = loopCount - 1;
}

```

**Figure 6-7** A while loop that displays “Hello” twice, decrementing the loopCount variable in the loop body

In the program segment shown in Figure 6-7, the variable `loopCount` begins with a value of 3. The `loopCount` is greater than 1, so the loop body displays “Hello” and decrements `loopCount` to 2. The Boolean expression in the `while` loop is tested again. Because 2 is more than 1, “Hello” is displayed again, and `loopCount` becomes 1. Now `loopCount` is not greater than 1, so the loop ends. There are many ways to execute a loop two times. For example, you can initialize a loop control variable to 10 and continue while the value is greater than 8, decreasing the value by 1 each time you pass through the loop. Similarly, you can initialize the loop control variable to 12, continue while it is greater than 2, and decrease the value by 5 each time. In general, you should not use such unusual methods to count repetitions because they simply make a program confusing. To execute a loop a specific number of times, the clearest and best method is to start the loop control variable at 0 or 1, increment by 1 each time through the loop, and stop when the loop control variable reaches the appropriate limit.



When you first start programming, it seems reasonable to initialize counter values to 1, and that is a workable approach. However, many seasoned programmers start counter values at 0 because they are used to doing so when working with arrays. When you study arrays in the chapter *Introduction to Arrays*, you will learn that their elements are numbered beginning with 0.



Watch the video *Looping*.

## Writing an Indefinite `while` Loop

You are not required to alter a loop control variable by adding to it or subtracting from it. Often, the value of a loop control variable is not altered by arithmetic, but instead is altered by user input. A loop controlled by the user is a type of indefinite loop because you don’t know how many times it will eventually loop. For example, perhaps you want to continue performing some task as long as the user indicates a desire to continue. In this case, while you are writing the program, you do not know whether the loop eventually will be executed two times, 200 times, or at all.



A definite loop is a **counter-controlled loop**. An indefinite loop is an **event-controlled loop**; that is, an event occurs that determines whether the loop continues.

Consider an application in which you ask the user for a bank balance and then ask whether the user wants to see the balance after interest has accumulated. Each time the user chooses to continue, an increased balance appears, reflecting one more year of accumulated interest. When the user finally chooses to exit, the program ends. The program appears in Figure 6-8.

```

import java.util.Scanner;
public class BankBalance
{
    public static void main(String[] args)
    {
        double balance;
        String response;
        char responseChar;
        int tempBalance;
        int year = 1;
        final double INT_RATE = 0.03;
        Scanner keyboard = new Scanner(System.in);
        System.out.print("Enter initial bank balance > ");
        balance = keyboard.nextDouble();
        keyboard.nextLine();
        System.out.println("Do you want to see next year's balance?");
        System.out.print("Enter y or n > ");
        response = keyboard.nextLine();
        responseChar = response.charAt(0);
        while(responseChar == 'y')
        {
            balance = balance + balance * INT_RATE;
            tempBalance = (int)(balance * 100);
            balance = tempBalance / 100.0;
            System.out.println("After year " + year + " at " + INT_RATE +
                " interest rate, balance is $" + balance);
            year = year + 1;
            System.out.print("Do you want to see the balance " +
                "\nat the end of another year? y or n? >");
            response = keyboard.nextLine();
            responseChar = response.charAt(0);
        }
    }
}

```

In Chapter 2, you learned to call `nextLine()` after numeric input so that the Enter key is consumed before using the next call to `nextLine()`.

The call to `charAt(0)` retrieves the first character from `response`.

These two statements round the balance to two decimal places.

**Figure 6-8** The BankBalance application

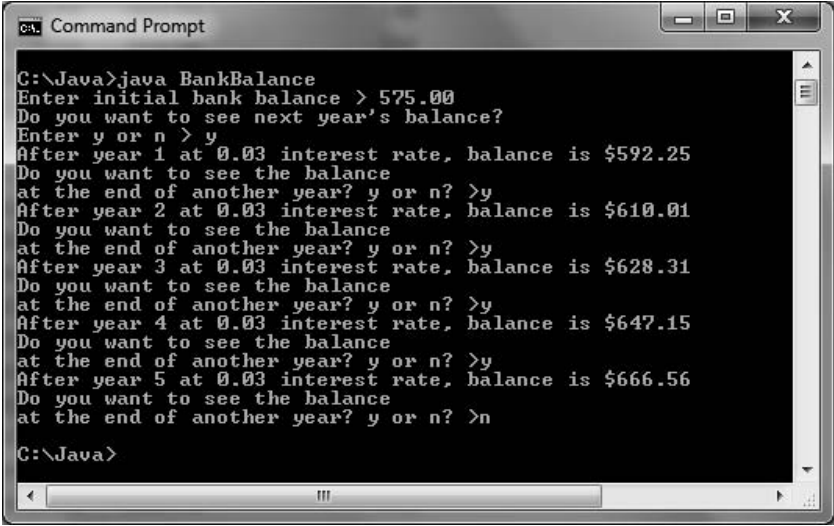
The program shown in Figure 6-8 declares needed variables and a constant for a 3% interest rate, and then asks the user for a balance. The application accepts a user's answer from the keyboard as a `String`, and then uses the first character of the `String` to determine whether the loop should continue. As long as the user wants to continue, the application continues to display increasing bank balances.

The loop in the application in Figure 6-8 begins with the line that contains:

```
while(responseChar == 'y')
```

If the user enters any value other than 'y', the loop body never executes; instead, the program ends. However, if the user enters 'y', all the statements within the loop body execute. The application increases the balance by the interest rate value. Then, the balance times 100 is cast to

an integer (for example, a calculated balance of 10.635 becomes 1063), and the result is divided by 100 (for example, 1063 becomes 10.63). The net effect of these two statements is to limit the number of decimal places in the balance to two. After these calculations, the application displays the new balance and asks whether the user wants another balance. The year variable increases and the loop body ends with a closing curly brace. After the loop body executes, control returns to the top of the loop, where the Boolean expression in the `while` loop is tested again. If the user enters 'y' to continue, the loop is entered and the process begins again. Figure 6-9 shows the output of the `BankBalance` application after the user enters a \$575.00 starting balance and responds with 'y' five times to the prompt for increased interest payments before responding 'n'.



```
CA: Command Prompt
C:\Java>java BankBalance
Enter initial bank balance > 575.00
Do you want to see next year's balance?
Enter y or n > y
After year 1 at 0.03 interest rate, balance is $592.25
Do you want to see the balance
at the end of another year? y or n? >y
After year 2 at 0.03 interest rate, balance is $610.01
Do you want to see the balance
at the end of another year? y or n? >y
After year 3 at 0.03 interest rate, balance is $628.31
Do you want to see the balance
at the end of another year? y or n? >y
After year 4 at 0.03 interest rate, balance is $647.15
Do you want to see the balance
at the end of another year? y or n? >y
After year 5 at 0.03 interest rate, balance is $666.56
Do you want to see the balance
at the end of another year? y or n? >n
C:\Java>
```

**Figure 6-9** Typical execution of the `BankBalance` application

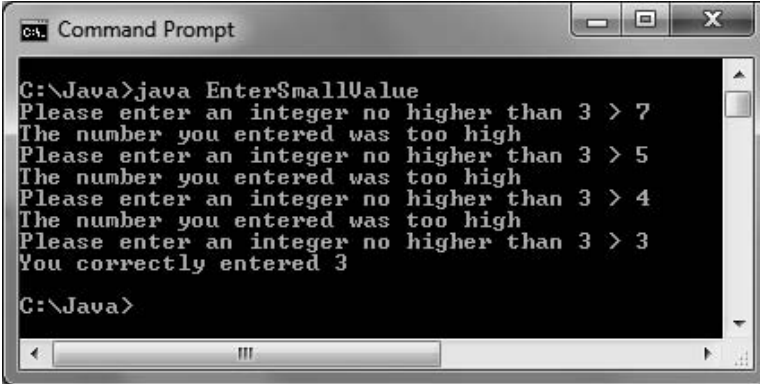
Programmers commonly use indefinite loops when validating input data. **Validating data** is the process of ensuring that a value falls within a specified range. For example, suppose you require a user to enter a value no greater than 3. Figure 6-10 shows an application that does not progress past the data entry loop until the user enters a correct value. If the user enters 3 or less at the first prompt, the shaded loop never executes. However, if the user enters a number greater than 3, the shaded loop executes, providing the user with another chance to enter a correct value. While the user continues to enter incorrect data, the loop repeats. Figure 6-11 shows a typical execution.



Figure 6-10 illustrates an excellent method for validating input. Before the loop is entered, the first input is retrieved. This first input might be a value that prevents any executions of the loop. This first input statement prior to the loop is called a **priming read** or **priming input**. Within the loop, the last statement retrieves subsequent input values for the same variable that will be checked at the entrance to the loop.

```
import java.util.Scanner;
public class EnterSmallValue
{
    public static void main(String[] args)
    {
        int userEntry;
        final int LIMIT = 3;
        Scanner input = new Scanner(System.in);
        System.out.print("Please enter an integer no higher than " +
            LIMIT + " > ");
        userEntry = input.nextInt();
        while(userEntry > LIMIT)
        {
            System.out.println("The number you entered was too high");
            System.out.print("Please enter an integer no higher than " +
                LIMIT + " > ");
            userEntry = input.nextInt();
        }
        System.out.println("You correctly entered " + userEntry);
    }
}
```

Figure 6-10 The EnterSmallValue application



```
cmd. Command Prompt
C:\Java>java EnterSmallValue
Please enter an integer no higher than 3 > 7
The number you entered was too high
Please enter an integer no higher than 3 > 5
The number you entered was too high
Please enter an integer no higher than 3 > 4
The number you entered was too high
Please enter an integer no higher than 3 > 3
You correctly entered 3
C:\Java>
```

Figure 6-11 Typical execution of the EnterSmallValue program

Novice programmers often make the mistake of checking for invalid data using a decision instead of a loop. That is, they ask whether the data is invalid using an `if` statement; if the data is invalid, they reprompt the user. However, they forget that a user might enter incorrect data multiple times. Usually, a loop is the best structure to use when validating input data.

## TWO TRUTHS & A LIE

### Creating while Loops

1. A finite loop executes a specific number of times; an indefinite loop is one that never ends.
2. A well-written while loop contains an initialized loop control variable that is tested in the while expression and then altered in the loop body.
3. In an indefinite loop, you don't know how many times the loop will occur.

The false statement is #1. A loop that executes a specific number of times is a definite loop or a counted loop; a loop that never ends is an infinite loop.

## Using Shortcut Arithmetic Operators

Programmers commonly need to increase the value of a variable in a program. As you saw in the previous section, many loops are controlled by continually adding 1 to some variable, as in `count = count + 1`; . Incrementing a variable in a loop to keep track of the number of occurrences of some event is also known as **counting**. Similarly, in the looping bank balance program shown in Figure 6-8, the program not only incremented the `year` variable by adding 1, but also increased a bank balance by an interest amount with the statement `balance = balance + balance * INT_RATE`; . In other words, the bank balance became its old value *plus* a new interest amount; the process of repeatedly increasing a value by some amount is known as **accumulating**.

Because increasing a variable is so common, Java provides you with several shortcuts for incrementing and accumulating. The expression `count += 1` is identical in meaning to `count = count + 1`. The `+=` is the **add and assign operator**; it adds and assigns in one operation. Similarly, `balance += balance * INT_RATE`; increases a balance by the `INT_RATE` percentage. Besides using the shortcut operator `+=`, you can use the **subtract and assign operator** (`-=`), the **multiply and assign operator** (`*=`), the **divide and assign operator** (`/=`), and the **remainder and assign operator** (`%=`). Each of these operators is used to perform the operation and assign the result in one step. For example, `balanceDue -= payment` subtracts `payment` from `balanceDue` and assigns the result to `balanceDue`.

When you want to increase a variable's value by exactly 1, you can use two other shortcut operators—the **prefix ++**, also known as the **prefix increment operator**, and the **postfix ++**, also known as the **postfix increment operator**. To use a prefix `++`, you type two plus signs before the variable name. The statement `someValue = 6`; followed by `++someValue`; results in `someValue` holding 7—one more than it held before you applied the `++`. To use a postfix `++`, you type two plus signs just after a variable name. The statements `anotherValue = 56`; `anotherValue++`; result in `anotherValue` containing 57. Figure 6-12 shows four ways you can increase a value by 1; each method produces the same result. You are never required to use shortcut operators; they are merely a convenience.



```

int value;
value = 24;
++value; // Result: value is 25
value = 24;
value++; // Result: value is 25
value = 24;
value = value + 1; // Result: value is 25
value = 24;
value += 1; // Result: value is 25

```

**Figure 6-12** Four ways to add 1 to a value



You can use the prefix ++ and postfix ++ with variables, but not with constants. An expression such as ++84; is illegal because an 84 must always remain an 84. However, you can create a variable as `int val = 84` and then write `++val`; or `val++`; to increase the variable's value.



The prefix and postfix increment operators are unary operators because you use them with one value. As you learned in Chapter 2, most arithmetic operators, such as those used for addition and multiplication, are binary operators—they operate on two values. Other examples of unary operators include the cast operator, as well as (+) and (–) when used to indicate positive and negative values.

When you simply want to increase a variable's value by 1, there is no difference between using the prefix and postfix increment operators. For example, when `value` is set to 24 in Figure 6-12, both `++value` and `value++` result in `value` becoming 25; each operator results in increasing the variable by 1. However, these operators do function differently in terms of *when* the increment operation occurs. When you use the prefix ++, the result is calculated and stored, and then the variable is used. For example, if `b = 4` and `c = ++b`, the result is that both `b` and `c` hold the value 5. When you use the postfix ++, the variable is used, and then the result is calculated and stored. For example, if `b = 4` and `c = b++`, 4 is assigned to `c`, and then after the assignment, `b` is increased and takes the value 5. In other words, if `b = 4`, the value of `b++` is also 4, but after the statement is completed, the value of `b` is 5. If `d = 8` and `e = 8`, both `++d == 9` and `e++ == 8` are true expressions.

Figure 6-13 shows an application that illustrates the difference between how the prefix and postfix increment operators work. Notice from the output in Figure 6-14 that when the prefix increment operator is used on `myNumber`, the value of `myNumber` increases from 17 to 18, and the result is stored in `answer`, which also becomes 18. After the value is reset to 17, the postfix increment operator is used; 17 is assigned to `answer`, and `myNumber` is incremented to 18.

Similar logic can be applied when you use the **prefix and postfix decrement operators**. For example, if `b = 4` and `c = b--`, 4 is assigned to `c`, and then after the assignment, `b` is decreased and takes the value 3. If `b = 4` and `c = --b`, `b` is decreased to 3 and 3 is assigned to `c`.



Watch the video *Using Shortcut Arithmetic Operators*.

```

public class IncrementDemo
{
    public static void main(String[] args)
    {
        int myNumber, answer;
        myNumber = 17;
        System.out.println("Before incrementing, myNumber is " +
            myNumber);
        answer = ++myNumber;
        System.out.println("After prefix increment, myNumber is " +
            myNumber);
        System.out.println(" and answer is " + answer);
        myNumber = 17;
        System.out.println("Before incrementing, myNumber is " +
            myNumber);
        answer = myNumber++;
        System.out.println("After postfix increment, myNumber is " +
            myNumber);
        System.out.println(" and answer is " + answer);
    }
}

```

Figure 6-13 The IncrementDemo application

```

C:\Java>java IncrementDemo
Before incrementing, myNumber is 17
After prefix increment, myNumber is 18
and answer is 18
Before incrementing, myNumber is 17
After postfix increment, myNumber is 18
and answer is 17
C:\Java>

```

Figure 6-14 Output of the IncrementDemo application

## TWO TRUTHS & A LIE

### Using Shortcut Arithmetic Operators

1. Assume  $x = 4$  and  $y = 5$ . The value of  $++y + ++x$  is 11.
2. Assume  $x = 4$  and  $y = 5$ . The value of  $y == x++$  is true.
3. Assume  $x = 4$  and  $y = 5$ . The value of  $y += x$  is 9.

The false statement is #2. If  $x$  is 4 and  $y$  is 5, then the value of  $x++$  is 4, and so  $y$  is not equal to 4.

## Creating a for Loop

A **for loop** is a special loop that is used when a definite number of loop iterations is required; it provides a convenient way to create a counter-controlled loop. Although a **while** loop can also be used to meet this requirement, the **for** loop provides you with a shorthand notation for this type of loop. When you use a **for** loop, you can indicate the starting value for the loop control variable, the test condition that controls loop entry, and the expression that alters the loop control variable—all in one convenient place.

You begin a **for** loop with the keyword **for** followed by a set of parentheses. Within the parentheses are three sections separated by exactly two semicolons. The three sections are usually used for the following:

- Initializing the loop control variable
- Testing the loop control variable
- Updating the loop control variable

The body of the **for** statement follows the parentheses. As with an **if** statement or a **while** loop, you can use a single statement as the body of a **for** loop, or you can use a block of statements enclosed in curly braces. The **for** statement shown in Figure 6-15 produces the same output as the **while** statement shown below it—both display the integers 1 through 10.

```
for(int val = 1; val < 11; ++val)
    System.out.println(val);

int val = 1;
while(val < 11)
{
    System.out.println(val);
    ++val;
}
```

**Figure 6-15** A **for** loop and a **while** loop that display the integers 1 through 10



The variable `val` did not have to be declared within the **for** statement. If `val` was declared earlier in the program block, the **for** statement would be `for(val = 1; val < 11; ++val)`. In other words, the **for** statement does not need to declare a loop control variable; it can simply give a starting value to a previously declared variable. However, programmers frequently declare a variable within a **for** statement just for use within that loop.



If you declare a variable within a **for** statement, the variable can only be used in the block that depends on the **for** statement; when the block ends, the variable goes out of scope.

Within the parentheses of the **for** statement shown in Figure 6-15, the first section prior to the first semicolon declares a variable named `val` and initializes it to 1. The program executes this statement once, no matter how many times the body of the **for** loop executes.

After initialization, program control passes to the middle, or test section, of the `for` statement that lies between the two semicolons. If the Boolean expression found there evaluates to `true`, the body of the `for` loop is entered. In the program segment shown in Figure 6-15, `val` is set to 1, so when `val < 11` is tested, it evaluates to `true`. The loop body displays `val`. In this example, the loop body is a single statement, so no curly braces are needed (although they could be added).

After the loop body executes, the final one-third of the `for` loop that follows the second semicolon executes, and `val` is increased to 2. Following the third section in the `for` statement, program control returns to the second section, where `val` is compared to 11 a second time. Because `val` is still less than 11, the body executes: `val` (now 2) is displayed, and then the third, altering portion of the `for` loop executes again. The variable `val` increases to 3, and the `for` loop continues.

Eventually, when `val` is not less than 11 (after 1 through 10 have been displayed), the `for` loop ends, and the program continues with any statements that follow the `for` loop. Although the three sections of the `for` loop are most commonly used for initializing, testing, and incrementing, you can also perform the following tasks:

- Initialization of more than one variable by placing commas between the separate statements, as in the following:

```
for(g = 0, h = 1; g < 6; ++g)
```

- Performance of more than one test using AND or OR operators, as in the following:

```
for(g = 0; g < 3 && h > 1; ++g)
```

- Decrementation or performance of some other task, as in the following:

```
for(g = 5; g >= 1; --g)
```

- Altering more than one value, as in the following:

```
for(g = 0; g < 10; ++g, ++h, sum += g)
```

- You can leave one or more portions of a `for` loop empty, although the two semicolons are still required as placeholders. For example, if `x` has been initialized in a previous program statement, you might write the following:

```
for(; x < 10; ++x)
```

However, to someone reading your program, leaving a section of a `for` statement empty is less clear than using all three sections.

In general, you should use the same loop control variable in all three parts of a `for` statement, although you might see some programs written by others in which this is not the case. You should also avoid altering the loop control variable in the body of the loop. If a variable is altered both within a `for` statement and within the block it controls, it can be very difficult to follow the program's logic. This technique can also produce program bugs that are hard to find. Usually, you should use the `for` loop for its intended purpose—as a shorthand way of programming a definite loop.

Occasionally, you will encounter a `for` loop that contains no body, such as the following:

```
for(x = 0; x < 100000; ++x);
```

This kind of loop exists simply to use time—that is, to occupy the central processing unit for thousands of processing cycles—when a brief pause is desired during program execution, for example. As with `if` and `while` statements, usually you do not want to place a semicolon at the end of the `for` statement before the body of the loop. Java also contains a built-in method to pause program execution. The `sleep()` method is part of the `Thread` class in the `java.lang` package, and you will learn how to use it as you continue to study Java.



Java also supports an enhanced `for` loop. You will learn about this loop in the chapter *Introduction to Arrays*.



Watch the video *Using the for Loop*.

## TWO TRUTHS & A LIE

### Creating a for Loop

1. A `for` loop always must contain two semicolons within its parentheses.
2. The body of a `for` loop might never execute.
3. Within the parentheses of a `for` loop, the last section must alter the loop control variable.

The false statement is #3. Frequently, the third section of a `for` loop is used to alter the loop control variable, but it is not required.

## Learning How and When to Use a do...while Loop

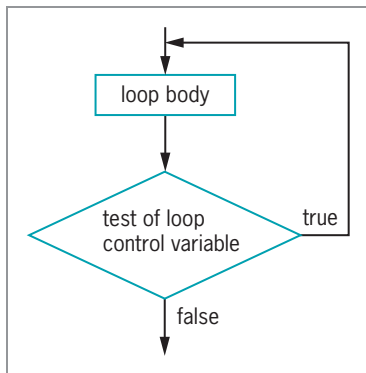
With all the loops you have written so far, the loop body might execute many times, but it is also possible that the loop will not execute at all. For example, recall the bank balance program that displays compound interest, which was shown in Figure 6-8. The program begins by asking whether the user wants to see next year's balance. If the user enters anything other than a line that starts with 'y', the loop body never executes.

Similarly, recall the `EnterSmallValue` application in Figure 6-10. The user is prompted to enter a value, and if the user enters a value that is 3 or less, the error-reporting loop body never executes.

In each of these cases, the loop control variable is evaluated at the “top” of the loop before the body has a chance to execute. Both `while` loops and `for` loops are **pretest loops**—ones in which the loop control variable is tested before the loop body executes.

Sometimes, you might need to ensure that a loop body executes at least one time. If so, you want to write a loop that checks at the “bottom” of the loop after the first iteration. The **do...while loop** checks the value of the loop control variable at the bottom of the loop after one repetition has occurred. The `do...while` loop is a **posttest loop**—one in which the loop control variable is tested after the loop body executes.

Figure 6-16 shows the general structure of a `do...while` loop. Notice that the loop body executes before the loop-controlling question is asked even one time. Figure 6-17 shows a `BankBalance2` application that contains a `do...while` loop. The loop starts with the shaded keyword `do`. The body of the loop follows and is contained within curly braces. The first year’s balance is output before the user has any option of responding. At the bottom of the loop, the user is prompted, “Do you want to see the balance at the end of another year?” Now the user has the option of seeing more balances, but viewing the first display was unavoidable. The user’s response is checked in the shaded evaluation at the bottom of the loop; if it is ‘y’ for *yes*, the loop repeats.



**Figure 6-16** General structure of a `do...while` loop

```
import java.util.Scanner;
public class BankBalance2
{
    public static void main(String[] args)
    {
        double balance;
        String response;
        char responseChar;
        int tempBalance;
        int year = 1;
        final double INT_RATE = 0.03;
        Scanner keyboard = new Scanner(System.in);
        System.out.print("Enter initial bank balance > ");
        balance = keyboard.nextDouble();
        keyboard.nextLine();
        do
        {
            balance = balance + balance * INT_RATE;
            tempBalance = (int)(balance * 100);
            balance = tempBalance / 100.0;
            System.out.println("After year " + year + " at " + INT_RATE +
                "interest rate, balance is $" + balance);
            year = year + 1;
            System.out.print("Do you want to see the balance " +
                "\nat the end of another year? y or n? > ");
            response = keyboard.nextLine();
            responseChar = response.charAt(0);
        } while(responseChar == 'y');
    }
}
```

**Figure 6-17** A do...while loop for the BankBalance2 application

You are never required to use a do...while loop. Within the bank balance example, you could achieve the same results as the logic shown in Figure 6-17 by unconditionally displaying the first year's bank balance once before starting the loop, prompting the user, and then starting a while loop that might not be entered. However, when you know you want to perform some task at least one time, the do...while loop is convenient.

When the body of a do...while loop contains a single statement, you do not need to use curly braces to block the statement. For example, the following loop correctly adds `numberValue` to `total` while `total` remains less than 200:

```
do
    total += numberValue;
while(total < 200);
```

Even though curly braces are not required in this case, many programmers recommend using them. Doing so prevents the third line of code from looking like it should begin a new while loop instead of ending the previous do...while loop. Therefore, even though the result is the same, the following example that includes curly braces is less likely to be misunderstood by a reader:

```
do
{
    total += numberValue;
} while(total < 200);
```

## TWO TRUTHS & A LIE

### Learning How and When to Use a do...while Loop

1. The do...while loop checks the value of the loop control variable at the top of the loop prior to loop execution.
2. When the statements in a loop body must execute at least one time, it is convenient to use a do...while loop.
3. When the body of a do...while loop contains a single statement, you do not need to use curly braces to block the statement.

The false statement is #1. The do...while loop checks the value of the loop control variable at the bottom of the loop after one repetition has occurred.

## Learning About Nested Loops

Just as if statements can be nested, so can loops. You can place a while loop within a while loop, a for loop within a for loop, a while loop within a for loop, or any other combination. When loops are nested, each pair contains an **inner loop** and an **outer loop**. The inner loop must be entirely contained within the outer loop; loops can never overlap. Figure 6-18 shows a diagram in which the shaded loop is nested within another loop; the shaded area is the inner loop. You can nest virtually any number of loops; however, at some point, your machine will no longer be able to store all the necessary looping information.

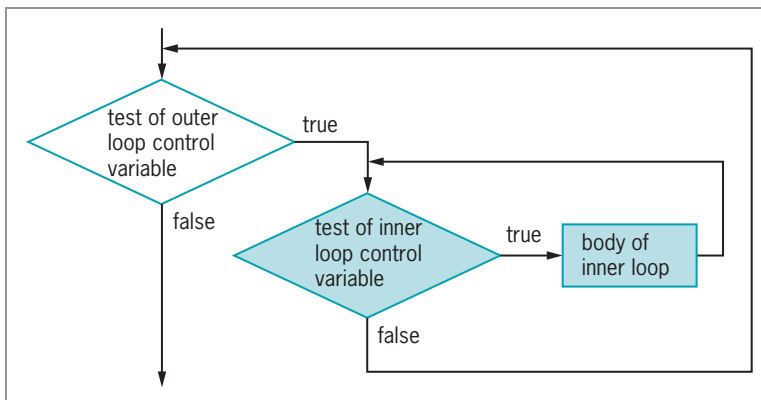


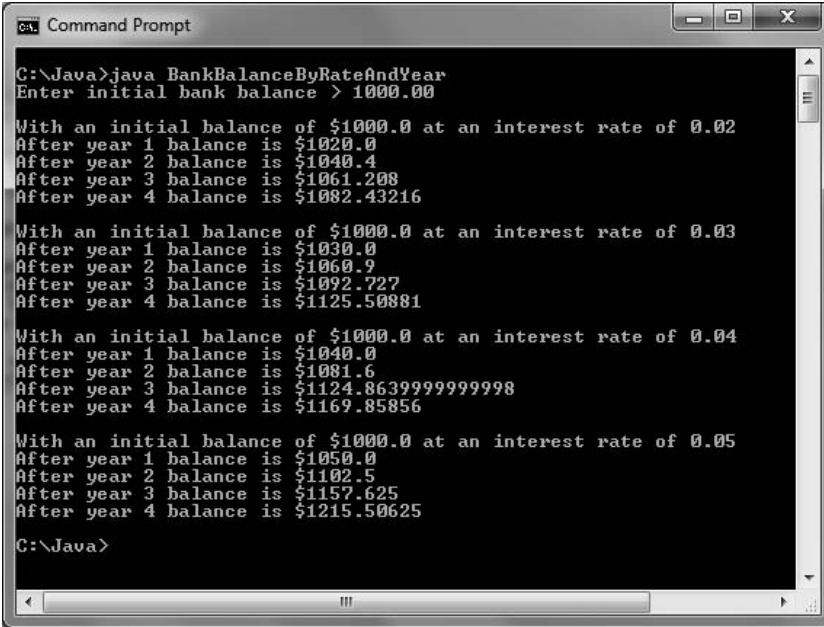
Figure 6-18 Nested loops



Suppose you want to display future bank balances while varying both years and interest rates. Figure 6-19 shows an application that contains an outer loop that varies interest rates between specified limits. At the start of the outer loop, the working balance is reset to its initial value so that calculations are correct for each revised interest rate value. The shaded inner loop varies the number of years and displays each calculated balance. Figure 6-20 shows a typical execution.

```
import java.util.Scanner;
public class BankBalanceByRateAndYear
{
    public static void main(String[] args)
    {
        double initialBalance;
        double balance;
        int year;
        double interest;
        final double LOW = 0.02;
        final double HIGH = 0.05;
        final double INCREMENT = 0.01;
        final int MAX_YEAR = 4;
        Scanner keyboard = new Scanner(System.in);
        System.out.print("Enter initial bank balance > ");
        initialBalance = keyboard.nextDouble();
        keyboard.nextLine();
        for(interest = LOW; interest <= HIGH; interest += INCREMENT)
        {
            balance = initialBalance;
            System.out.println("\nWith an initial balance of $" +
                balance + " at an interest rate of " + interest);
            for(year = 1; year <= MAX_YEAR; ++ year)
            {
                balance = balance + balance * interest;
                System.out.println("After year " + year +
                    " balance is $" + balance);
            }
        }
    }
}
```

**Figure 6-19** The `BankBalanceByRateAndYear` class containing nested loops



```

C:\Java>java BankBalanceByRateAndYear
Enter initial bank balance > 1000.00

With an initial balance of $1000.0 at an interest rate of 0.02
After year 1 balance is $1020.0
After year 2 balance is $1040.4
After year 3 balance is $1061.208
After year 4 balance is $1082.43216

With an initial balance of $1000.0 at an interest rate of 0.03
After year 1 balance is $1030.0
After year 2 balance is $1060.9
After year 3 balance is $1092.727
After year 4 balance is $1125.50881

With an initial balance of $1000.0 at an interest rate of 0.04
After year 1 balance is $1040.0
After year 2 balance is $1081.6
After year 3 balance is $1124.8639999999998
After year 4 balance is $1169.85856

With an initial balance of $1000.0 at an interest rate of 0.05
After year 1 balance is $1050.0
After year 2 balance is $1102.5
After year 3 balance is $1157.625
After year 4 balance is $1215.50625

C:\Java>

```

**Figure 6-20** Typical execution of the `BankBalanceByRateAndYear` program



In Figure 6-20, the floating-point calculations result in balances that contain fractions of pennies. If you wrote this program for a bank, you would have to ask whether interest should be compounded on fractions of a cent as it is here, or whether the amounts should be either rounded or truncated.

When you nest loops, sometimes it doesn't make any difference which variable controls the outer loop and which variable controls the inner one, but frequently it does make a difference. When you use a loop within a loop, you should always think of the outer loop as the all-encompassing loop. The variable in the outer loop changes more infrequently. For example, suppose a method named `outputLabel()` creates customer mailing labels in three different colors to use in successive promotional mailings. The following nested loop calls the method 60 times and produces three labels for the first customer, three labels for the second customer, and so on:

```

for(customer = 1; customer <= 20; ++customer)
    for(color = 1; color <= 3; ++color)
        outputLabel();

```

The following nested loop also calls `outputLabel()` 60 times, and it ultimately produces the same 60 labels, but it creates 20 labels in the first color, 20 labels in the second color, and then 20 labels in the third color.

```

for(color = 1; color <= 3; ++color)
    for(customer = 1; customer <= 20; ++customer)
        outputLabel();

```

If changing the ink color is a time-consuming process that occurs in the method, the second nested loop might execute much faster than the first one.



Watch the video *Nested Loops*.

## TWO TRUTHS & A LIE

### Learning About Nested Loops

1. You can place a `while` loop within a `while` loop or a `for` loop within a `for` loop, but you cannot mix loop types.
2. An inner nested loop must be entirely contained within its outer loop.
3. The body of the following loop executes 20 times:

```
for(int x = 0; x < 4; ++x)
    for(int y = 0; y < 5; ++y)
        System.out.println("Hi");
```

The false statement is #1. You can place a `while` loop within a `while` loop, a `for` loop within a `for` loop, a `while` loop within a `for` loop, or any other combination.

## Improving Loop Performance

Whether you decide to use a `while`, `for`, or `do...while` loop in an application, you can improve loop performance by doing the following:

- Making sure the loop does not include unnecessary operations or statements
- Considering the order of evaluation for short-circuit operators
- Making a comparison to 0
- Employing loop fusion

## Avoiding Unnecessary Operations

You can make loops more efficient by not using unnecessary operations or statements, either within a loop's tested expression or within the loop body. For example, suppose a loop should execute while `x` is less than the sum of two integers, `a` and `b`. The loop could be written as:

```
while(x < a + b)
    // loop body
```

**Don't Do It**  
It might be inefficient to recalculate `a + b` for every loop iteration.

If this loop executes 1,000 times, then the expression `a + b` is calculated 1,000 times. Instead, if you use the following code, the results are the same, but the arithmetic is performed only once:

```
int sum = a + b;
while(x < sum)
    // loop body
```

Of course, if `a` or `b` is altered in the loop body, then a new sum must be calculated with every loop iteration. However, if the sum of `a` and `b` is fixed prior to the start of the loop, then writing the code the second way is far more efficient.

282

Similarly, try to avoid a method call within a loop if possible. For example, if the method `getNumberOfEmployees()` always returns the same value during a program's execution, then a loop that begins as follows might unnecessarily call the method many times:

```
while(count < getNumberOfEmployees())...
```

It is more efficient to call the method once, store the result in a variable, and use the variable in the repeated evaluations.

## Considering the Order of Evaluation of Short-Circuit Operators

In Chapter 5 you learned that the expressions in each part of an AND or an OR expression use short-circuit evaluation; that is, they are evaluated only as much as necessary to determine whether the entire expression is `true` or `false`. When a loop might execute many times, it becomes increasingly important to consider the number of evaluations that take place.

For example, suppose a user can request any number of printed copies of a report from 0 to 15, and you want to validate the user's input before proceeding. If you believe that users are far more likely to enter a value that is too high than to enter a negative one, then you want to start a loop that reprompts the user with the following expression:

```
while(requestedNum > LIMIT || requestedNum < 0)...
```

Because you believe that the first Boolean expression is more likely to be `true` than the second one, you can eliminate testing the second one on more occasions. The order of the expressions is not very important in a single loop, but if this loop is nested within another loop, then the difference in the number of tests increases. Similarly, the order of the evaluations in `if` statements is more important when the `if` statements are nested within a loop.

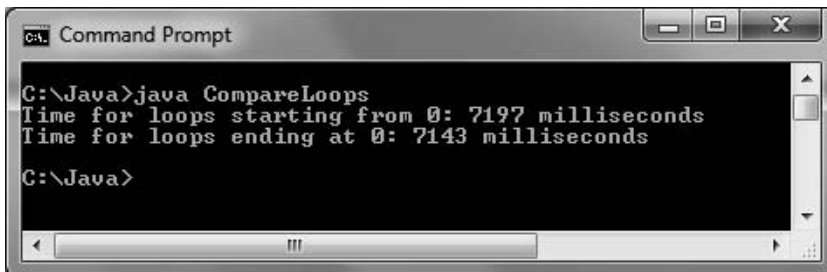
## Comparing to Zero

Making a comparison to 0 is faster than making a comparison to any other value. Therefore, if your application makes comparison to 0 feasible, you can improve loop performance by structuring your loops to compare the loop control variable to 0 instead of some other value. For example, a loop that performs based on a variable that varies from 0 up to 100,000 executes the same number of times as a loop based on a variable that varies from 100,000 down to 0. However, the second loop performs slightly faster. Comparing a value to 0 instead of other values is faster because in a compiled language, condition flags for the comparison are set once, no matter how many times the loop executes. Comparing a value to 0 is faster than comparing to other values, no matter which comparison operator you use—greater than, less than, equal to, and so on.

Figure 6-21 contains a program that tests the execution times of two nested do-nothing loops. (A **do-nothing loop** is one that performs no actions other than looping.) Before each loop, the `System` method `currentTimeMillis()` is called to retrieve the current time represented in milliseconds. After each nested loop repeats 100,000 times, the current time is retrieved again. Subtracting the two times computes the interval. As the execution in Figure 6-22 shows, there is a small difference in execution time between the two loops—about 1/100 of a second. The amount of time will vary on different machines, but the loop that uses the 0 comparison will never be slower than the other one. The difference would become more pronounced with additional repetitions or further nesting levels. If the loops used the loop control variable, for example, to display a count to the user, then they might need to increment the variable. However, if the purposes of the loops are just to count iterations, you might consider making the loop comparison use 0.

```
public class CompareLoops
{
    public static void main(String[] args)
    {
        long startTime1, startTime2, endTime1, endTime2;
        final int REPEAT = 100000;
        startTime1 = System.currentTimeMillis();
        for(int x = 0; x <= REPEAT; ++x)
            for(int y = 0; y <= REPEAT; ++y);
        endTime1 = System.currentTimeMillis();
        System.out.println("Time for loops starting from 0: " +
            (endTime1 - startTime1) + " milliseconds");
        startTime2 = System.currentTimeMillis();
        for(int x = REPEAT; x >= 0; --x)
            for(int y = REPEAT; y >= 0; --y);
        endTime2 = System.currentTimeMillis();
        System.out.println("Time for loops ending at 0: " +
            (endTime2 - startTime2) + " milliseconds");
    }
}
```

**Figure 6-21** The `CompareLoops` application



```
C:\Java>java CompareLoops
Time for loops starting from 0: 7197 milliseconds
Time for loops ending at 0: 7143 milliseconds
C:\Java>
```

**Figure 6-22** Execution of the `CompareLoops` application

## Employing Loop Fusion

**Loop fusion** is the technique of combining two loops into one. For example, suppose you want to call two methods 100 times each. You can set a constant named `TIMES` to 100 and use the following code:

```
for(int x = 0; x < TIMES; ++x)
    method1();
for(int x = 0; x < TIMES; ++x)
    method2();
```

However, you can also use the following code:

```
for(int x = 0; x < TIMES; ++x)
{
    method1();
    method2();
}
```

Fusing loops will not work in every situation; sometimes all the activities for `method1()` must be finished before those in `method2()` can begin. However, if the two methods do not depend on each other, fusing the loops can improve performance.

As you become an experienced programmer, you will discover other ways to enhance the operation of the programs you write. You should always be on the lookout for ways to improve program performance. However, if saving a few milliseconds ends up making your code harder to understand, you almost always should err in favor of slower but more readable programs.

### TWO TRUTHS & A LIE

#### Improving Loop Performance

1. You can improve the performance of a loop by making sure the loop does not include unnecessary operations in the tested expression.
2. You can improve loop performance by making sure the loop does not include unnecessary operations in the body of the loop.
3. You can improve loop performance when two conditions must both be true by testing for the most likely occurrence first.

The false statement is #3. You can improve loop performance when two conditions must both be true by testing for the least likely occurrence first. That way, the second test will need to be performed less frequently.

## You Do It

### Writing a Loop to Validate Data Entries

In Chapter 5, you created a `ChooseManager` application that allowed the user to enter a 1 or 2 to select a private or corporate event to be held by an event-handling organization. The output was the name of the manager in charge of the event type. Next, you will improve the `ChooseManager` program so the user cannot make an invalid choice for the type of event—if the user does not enter a 1 or 2, the user will continue to be prompted until a valid selection is entered.

#### To improve the `ChooseManager` program to prevent invalid data entry:

1. Enter the first lines of the `ChooseManagerWithValidation` class. Except for the class name, these statements are identical to those in the `ChooseManager` class you created in Chapter 5, so you can save time if you want by copying these lines of code from that file. The statements create a `ChooseManagerWithValidation` class and start a `main()` method that contains constants for the managers' codes and names. The user is prompted to enter a 1 or 2, representing a private or corporate event:

```
import java.util.Scanner;
public class ChooseManagerWithValidation
{
    public static void main(String[] args)
    {
        int eventType;
        String chosenManager;
        final int PRIVATE_CODE = 1;
        final int CORPORATE_CODE = 2;
        final String PRIV_MANAGER = "Dustin Britt";
        final String CORP_MANAGER = "Carmen Lindsey";
        Scanner input = new Scanner(System.in);
        System.out.println
            ("What type of event are you scheduling?");
        System.out.print("Enter " + PRIVATE_CODE +
            " for private, " + CORPORATE_CODE +
            " for corporate.. ");
        eventType = input.nextInt();
```

2. Type the `while` loop that will continue to execute while the user's entry is not one of the two allowed event types. When the user's entry is not a 1 and not a 2, the user is informed of the error and is allowed to type a new choice:

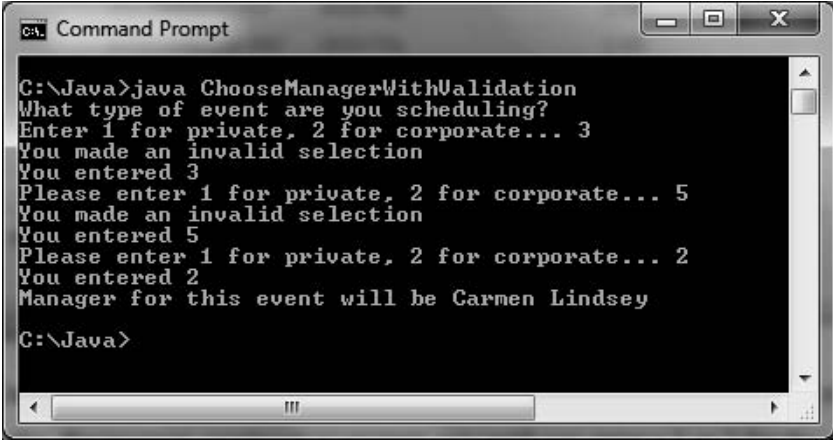
```
while(eventType != PRIVATE_CODE && eventType != CORPORATE_CODE)
{
    System.out.println("You made an invalid selection");
    System.out.println("You entered " + eventType);
    System.out.print("Please enter " + PRIVATE_CODE +
        " for private, " + CORPORATE_CODE + " for corporate.. ");
    eventType = input.nextInt();
}
```

3. On a new line, type the decision structure that sets the `chosenManager` variable. If the `eventType` is not 1, then it must be 2, or the program would still be executing the loop waiting for a 1 or 2 from the user:

```
if(eventType == PRIVATE_CODE)
    chosenManager = PRIV_MANAGER;
else
    chosenManager = CORP_MANAGER;
```

4. Display the manager for the chosen event type:

```
System.out.println("You entered " + eventType);
System.out.println("Manager for this event will be " +
    chosenManager);
```
5. Add the closing curly brace for the `main()` method and the closing curly brace for the class. Save the file as **ChooseManagerWithValidation.java**.
6. Compile and execute the application. No matter how many invalid entries you make, the program continues to prompt you until you enter a 1 or 2 for the event type. Figure 6-23 shows a typical execution.



```
C:\Java>java ChooseManagerWithValidation
What type of event are you scheduling?
Enter 1 for private, 2 for corporate... 3
You made an invalid selection
You entered 3
Please enter 1 for private, 2 for corporate... 5
You made an invalid selection
You entered 5
Please enter 1 for private, 2 for corporate... 2
You entered 2
Manager for this event will be Carmen Lindsey

C:\Java>
```

**Figure 6-23** Typical execution of the `ChooseManagerWithValidation` program

## Working with Prefix and Postfix Increment Operators

Next, you will write an application that demonstrates how prefix and postfix operators are used in incrementation and how incrementing affects the expressions that contain these operators.



### To demonstrate the effect of the prefix and postfix increment operators:

1. Open a new text file and begin a demonstration class named `DemoIncrement` by typing:

```
public class DemoIncrement
{
    public static void main(String[] args)
    {
```

2. On a new line, add a variable `v` and assign it a value of 4. Then declare a variable named `plusPlusV` and assign it a value of `++v` by typing:

```
int v = 4;
int plusPlusV = ++v;
```

3. The last statement, `int plusPlusV = ++v;`, will increase `v` to 5, so before declaring a `vPlusPlus` variable to which you assign `v++`, reset `v` to 4 by typing:

```
v = 4;
int vPlusPlus = v++;
```

4. Add the following statements to display the three values:

```
System.out.println("v is " + v);
System.out.println("++v is " + plusPlusV);
System.out.println("v++ is " + vPlusPlus);
```

5. Add the closing curly brace for the `main()` method and the closing curly brace for the `DemoIncrement` class. Save the file as **DemoIncrement.java**, then compile and execute the program. Your output should look like Figure 6-24.

6. To illustrate how comparisons are made, add a few more variables to the `DemoIncrement` program. Change the class name to **DemoIncrement2**, and immediately save the file as **DemoIncrement2.java**.

7. After the last `println()` statement, add three new integer variables and two new Boolean variables. The first Boolean variable compares `++w` to `y`; the second Boolean variable compares `x++` to `y`:

```
int w = 17, x = 17, y = 18;
boolean compare1 = (++w == y);
boolean compare2 = (x++ == y);
```



```

C:\Java>java DemoIncrement
v is 5
++v is 5
v++ is 4
C:\Java>

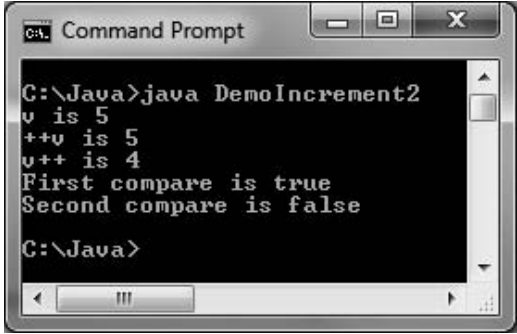
```

**Figure 6-24** Output of the `DemoIncrement` class

8. Add the following statements to display the values stored in the compare variables:

```
System.out.println("First compare is " + compare1);
System.out.println("Second compare is " + compare2);
```

9. Save, compile, and run the program. The output appears in Figure 6-25. Make certain you understand why each statement displays the values it does. Experiment by changing the values of the variables, and see if you can predict the output before recompiling and rerunning the program.



```
C:\Java>java DemoIncrement2
v is 5
++v is 5
v++ is 4
First compare is true
Second compare is false
C:\Java>
```

**Figure 6-25** Output of the DemoIncrement2 application

## Working with Definite Loops

Suppose you want to find all the numbers that divide evenly into 100. You want to write a definite loop—one that executes exactly 100 times. You can write a for loop that sets a variable to 1 and increments it to 100. Each of the 100 times through the loop, if 100 is evenly divisible by the variable, the application displays the number.

### To write an application that finds the values that divide evenly into 100:

1. Open a new text file. Begin the application named `DivideEvenly` by typing the following code. Use a named constant for the 100 value and a variable named `var` that will hold, in turn, every value from 1 through 100:

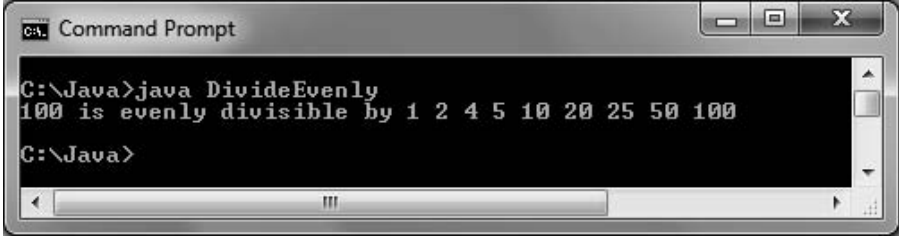
```
public class DivideEvenly
{
  public static void main(String[] args)
  {
    final int LIMIT = 100;
    int var;
```

2. Type a statement that explains the purpose of the program:
 

```
System.out.print(LIMIT + " is evenly divisible by ");
```
3. Write the for loop that varies `var` from 1 through 100. With each iteration of the loop, test whether `100 % var` is 0. If you divide 100 by a number and there is no remainder, the number goes into 100 evenly.

```
for(var = 1; var <= LIMIT; ++var)
  if(LIMIT % var == 0)
    System.out.print(var + " ");
  // Display the number and two spaces
```

4. Add an empty `println()` statement to advance the insertion point to the next line by typing the following:  
**`System.out.println();`**
5. Type the closing curly braces for the `main()` method and the `DivideEvenly` class.
6. Save the program as **`DivideEvenly.java`** Compile and run the program. Figure 6-26 shows the output.



```

C:\Java>java DivideEvenly
100 is evenly divisible by 1 2 4 5 10 20 25 50 100
C:\Java>

```

**Figure 6-26** Output of the `DivideEvenly` application



By definition, no value that is greater than half of `LIMIT` can possibly go into `LIMIT` evenly. Therefore, the loop in the `DivideEvenly` program could be made to execute faster if the loop executes while `var` is less than or equal to half of `LIMIT`.

## Working with Nested Loops

Suppose you want to know not just what numbers go evenly into 100, but also what numbers go evenly into every positive number, up to and including 100. You can write 99 more loops—one that shows the numbers that divide evenly into 1, another that shows the numbers that divide evenly into 2, and so on—or you can place the current loop inside a different, outer loop, as you will do next.



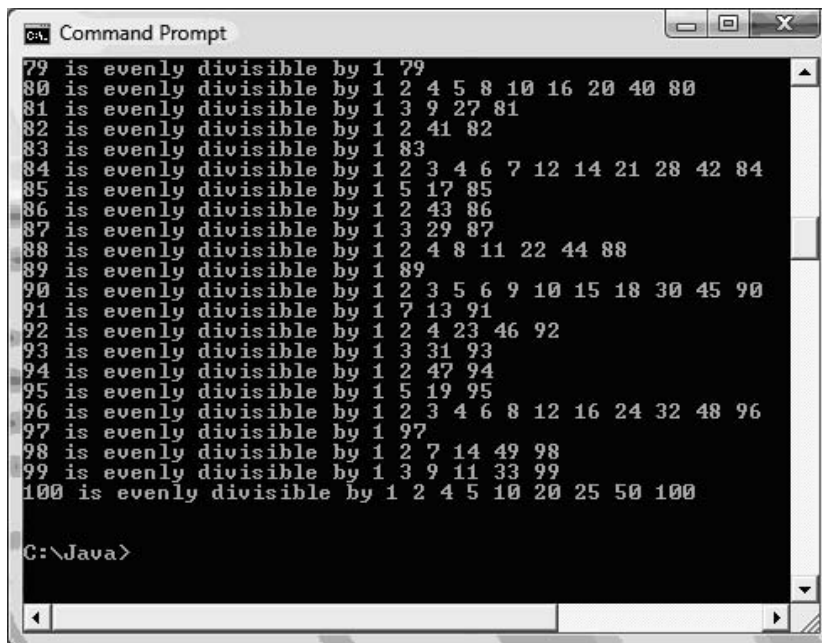
If you want to display divisors for each number from 1 to 100, the loop that varies the number to be divided is the outside loop. You need to perform 100 mathematical calculations on each number, so that constitutes the “smaller” or inside loop.

### To create a nested loop to display even divisors for every number up to 100:

1. If necessary, open the file **`DivideEvenly.java`** in your text editor, change the class name to **`DivideEvenly2`**, and then save the class as **`DivideEvenly2.java`**.
2. Add a new variable declaration:  
**`int number;`**
3. Replace the existing `for` loop with the following nested loop. The outer loop varies `number` from 1 to 100. For each number in the outer loop, the inner loop uses each positive integer from 1 up to the number, and tests whether it divides evenly into the number:

```
for(number = 1; number <= LIMIT; ++number)
{
    System.out.print(number + " is evenly divisible by ");
    for(var = 1; var <= number; ++var)
        if(number % var == 0)
            System.out.print(var + " ");
    // Display the number and two spaces
    System.out.println();
}
```

4. Make certain the file ends with three curly braces—one for the for outer loop that varies number, one for the main() method, and one for the class. The inner loop does not need curly braces because it contains a single output statement.
5. Save the file as **DivideEvenly2.java**, compile, and execute the application. When the output stops scrolling, it should look similar to Figure 6-27.



```
Command Prompt
79 is evenly divisible by 1 79
80 is evenly divisible by 1 2 4 5 8 10 16 20 40 80
81 is evenly divisible by 1 3 9 27 81
82 is evenly divisible by 1 2 41 82
83 is evenly divisible by 1 83
84 is evenly divisible by 1 2 3 4 6 7 12 14 21 28 42 84
85 is evenly divisible by 1 5 17 85
86 is evenly divisible by 1 2 43 86
87 is evenly divisible by 1 3 29 87
88 is evenly divisible by 1 2 4 8 11 22 44 88
89 is evenly divisible by 1 89
90 is evenly divisible by 1 2 3 5 6 9 10 15 18 30 45 90
91 is evenly divisible by 1 7 13 91
92 is evenly divisible by 1 2 4 23 46 92
93 is evenly divisible by 1 3 31 93
94 is evenly divisible by 1 2 47 94
95 is evenly divisible by 1 5 19 95
96 is evenly divisible by 1 2 3 4 6 8 12 16 24 32 48 96
97 is evenly divisible by 1 97
98 is evenly divisible by 1 2 7 14 49 98
99 is evenly divisible by 1 3 9 11 33 99
100 is evenly divisible by 1 2 4 5 10 20 25 50 100

C:\Java>
```

Figure 6-27 Output of the DivideEvenly2 application when scrolling stops

## Don't Do It

- Don't insert a semicolon at the end of a while clause before the loop body; doing so creates an empty loop body.
- Don't forget to block multiple statements that should execute in a loop.
- Don't make the mistake of checking for invalid data using a decision instead of a loop. Users might enter incorrect data multiple times, so a loop is the superior choice for input validation.

- Don't ignore subtleties in the boundaries used to stop loop performance. For example, looping while interest rates are less than 8% is different than looping while interest rates are no more than 8%.
- Don't repeat steps within a loop that could just as well be placed outside the loop; your program performance will improve.

## Key Terms

A **loop** is a structure that allows repeated execution of a block of statements.

A **loop body** is the block of statements that executes when the Boolean expression that controls the loop is `true`.

An **iteration** is one loop execution.

A **while loop** executes a body of statements continually as long as the Boolean expression that controls entry into the loop continues to be `true`.

A loop that executes a specific number of times is a **definite loop** or a counted loop.

An **indefinite loop** is one in which the final number of loops is unknown.

A **loop control variable** is a variable whose value determines whether loop execution continues.

An **infinite loop** is a loop that never ends.

An **empty body** is a block with no statements in it.

**Incrementing** a variable adds 1 to its value.

**Decrementing** a variable reduces its value by 1.

A definite loop is a **counter-controlled loop**.

An indefinite loop is an **event-controlled loop**.

**Validating data** is the process of ensuring that a value falls within a specified range.

A **priming read** or **priming input** is the first input statement prior to a loop that will execute subsequent input statements for the same variable.

**Counting** is the process of continually incrementing a variable to keep track of the number of occurrences of some event.

**Accumulating** is the process of repeatedly increasing a value by some amount to produce a total.

The **add and assign operator** ( `+=` ) alters the value of the operand on the left by adding the operand on the right to it.

The **subtract and assign operator** ( `-=` ) alters the value of the operand on the left by subtracting the operand on the right from it.

The **multiply and assign operator** (`*=`) alters the value of the operand on the left by multiplying the operand on the right by it.

The **divide and assign operator** (`/=`) alters the value of the operand on the left by dividing the operand on the right into it.

The **remainder and assign operator** (`%=`) alters the value of the operand on the left by assigning the remainder when the left operand is divided by the right operand.

The **prefix ++**, also known as the **prefix increment operator**, adds 1 to a variable, then evaluates it.

The **postfix ++**, also known as the **postfix increment operator**, evaluates a variable, then adds 1 to it.

The **prefix and postfix decrement operators** subtract 1 from a variable. For example, if `b = 4;` and `c = b--;`, 4 is assigned to `c`, and then after the assignment, `b` is decreased and takes the value 3. If `b = 4;` and `c = --b;`, `b` is decreased to 3, and 3 is assigned to `c`.

A **for loop** is a special loop that can be used when a definite number of loop iterations is required.

A **pretest loop** is one in which the loop control variable is tested before the loop body executes.

The **do...while loop** executes a loop body at least one time; it checks the loop control variable at the bottom of the loop after one repetition has occurred.

A **posttest loop** is one in which the loop control variable is tested after the loop body executes.

An **inner loop** is contained entirely within another loop.

An **outer loop** contains another loop.

A **do-nothing loop** is one that performs no actions other than looping.

**Loop fusion** is the technique of combining two loops into one.

## Chapter Summary

- A loop is a structure that allows repeated execution of a block of statements. Within a looping structure, a Boolean expression is evaluated, and if it is `true`, a block of statements called the loop body executes; then the Boolean expression is evaluated again.
- You can use a `while` loop to execute a body of statements continually while some condition continues to be `true`. To execute a `while` loop, you initialize a loop control variable, test it in a `while` statement, and then alter the loop control variable in the body of the `while` structure.
- The add and assign operator (`+=`) adds and assigns in one operation. Similar versions are available for subtraction, multiplication, and division. The prefix `++` and the postfix `++` increase a variable's value by 1. The prefix `--` and postfix `--` decrement operators reduce a variable's value by 1. When you use the prefix `++`, the result is calculated and stored, and then the variable is used. When you use the postfix `++`, the variable is used, and then the result is calculated and stored.

- A for loop initializes, tests, and increments in one statement. There are three sections within the parentheses of a for loop that are separated by exactly two semicolons.
- The do..while loop tests a Boolean expression after one repetition has taken place, at the bottom of the loop.
- Loops can be nested.
- You can improve loop performance by making sure the loop does not include unnecessary operations or statements.

## Review Questions

1. A structure that allows repeated execution of a block of statements is a \_\_\_\_\_.
  - a. cycle
  - b. loop
  - c. ring
  - d. band
2. A loop that never ends is a(n) \_\_\_\_\_ loop.
  - a. iterative
  - b. infinite
  - c. structured
  - d. illegal
3. To construct a loop that works correctly, you should initialize a loop control \_\_\_\_\_.
  - a. variable
  - b. constant
  - c. structure
  - d. condition
4. What is the output of the following code?

```
b = 1;
while(b < 4)
    System.out.print(b + " ");
```

  - a. 1
  - b. 1 2 3
  - c. 1 2 3 4
  - d. 1 1 1 1 1 1...
5. What is the output of the following code?

```
b = 1;
while(b < 4)
{
    System.out.print(b + " ");
    b = b + 1;
}
```

  - a. 1
  - b. 1 2 3
  - c. 1 2 3 4
  - d. 1 1 1 1 1 1...

6. What is the output of the following code?
- ```
e = 1;
while(e < 4);
    System.out.print(e + " ");
```
- a. Nothing  
b. 1 1 1 1 1 1...  
c. 1 2 3 4  
d. 4 4 4 4 4 4...
7. If `total = 100` and `amt = 200`, then after the statement `total += amt`, \_\_\_\_\_.
- a. `total` is equal to 200  
b. `total` is equal to 300  
c. `amt` is equal to 100  
d. `amt` is equal to 300
8. The modulus operator ( `%` ) is a \_\_\_\_\_ operator.
- a. unary  
b. binary  
c. tertiary  
d. postfix
9. The prefix `++` is a \_\_\_\_\_ operator.
- a. unary  
b. binary  
c. tertiary  
d. postfix
10. If `g = 5`, then after `h = ++g`, the value of `h` is \_\_\_\_\_.
- a. 4  
b. 5  
c. 6  
d. 7
11. If `m = 9`, then after `n = m++`, the value of `n` is \_\_\_\_\_.
- a. 8  
b. 9  
c. 10  
d. 11
12. If `j = 5` and `k = 6`, then the value of `j++ == k` is \_\_\_\_\_.
- a. 5  
b. 6  
c. `true`  
d. `false`
13. You must always include \_\_\_\_\_ in a `for` loop's parentheses.
- a. two semicolons  
b. three semicolons  
c. two commas  
d. three commas
14. What does the following statement output?
- ```
for(a = 0; a < 5; ++a)
    System.out.print(a + " ");
```
- a. 0 0 0 0 0  
b. 0 1 2 3 4  
c. 0 1 2 3 4 5  
d. Nothing





## Exercises

1. Write an application that displays all even numbers from 2 to 100 inclusive, and that starts a new line after every multiple of 20 (20, 40, 60, and 80). Save the file as **EvenNums.java**.
2. Write an application that asks a user to type 1, 2, 3, or 4. When the user types 4, the program ends. When the user types 1, 2, or 3, the program displays the message “Good job!” and then asks for another input. When the user types anything else, the application issues an error message and then asks for another input. Save the file as **Input123.java**.
3. Write an application that displays every integer value from 1 to 20 along with the squared value of each integer. Save the file as **TableOfSquares.java**.
4. Write an application that sums the integers from 1 to 50 (that is,  $1 + 2 + 3 + \dots + 50$ ). Save the file as **Sum50.java**.
5. Write an application that shows the sum of 1 to  $n$  for every  $n$  from 1 to 50. That is, the program displays 1 (the sum of 1 alone), 3 (the sum of 1 and 2), 6 (the sum of 1, 2, and 3), 10 (the sum of 1, 2, 3, and 4), and so on. Save the file as **EverySum.java**.
6. Write an application that displays every perfect number from 1 through 1,000. A perfect number is one that equals the sum of all the numbers that divide evenly into it. For example, 6 is perfect because 1, 2, and 3 divide evenly into it, and their sum is 6; however, 12 is not a perfect number because 1, 2, 3, 4, and 6 divide evenly into it, and their sum is greater than 12. Save the file as **Perfect.java**.
7.
  - a. Write an application that calculates the amount of money earned on an investment, based on an 8% annual return. Prompt the user to enter an investment amount and the number of years for the investment. Display an error message if the user enters 0 for either value; otherwise, display the total amount (balance) for each year of the investment. Save the file as **Investment.java**.
  - b. Modify the **Investment** application in Exercise 7a so the user also enters the interest rate. In addition to the error message that is displayed when the investment or term is 0, display an error message if the interest rate is 0. Save the file as **Investment2.java**.
8. Write an application that displays a series of at least four survey questions; the survey can be on any social or political topic you want, and each question should have at least three possible numeric-choice answers. At the end of the survey, use a dialog box to ask whether the user wants to (1) enter another set of responses to the same set of questions, or (2) quit. Continue to accept sets of responses until the user chooses to quit, and then display the results of the survey—for each question indicate how many users chose the first option, second option, and so on. Save the file as **Survey.java**.
9.
  - a. Write an application that displays the results of a series of 10 coin tosses. Use the `Math.random()` function explained in Appendix D to generate a number between 0 and 1; you will use a statement similar to:  

```
result = Math.random();
```

After each coin toss, display whether the toss represents “heads” or “tails.” If the `result` is 0.5 or less, the result represents heads; otherwise, it represents tails. After the 10 tosses are complete, display the percentages of heads and tails. Run the application several times until you are confident that the coin tosses occur randomly. Save the file as **FlipCoin.java**.

- b. Modify the application in Exercise 9a so that you generate 1,000 coin tosses and keep track of the heads and tails. Do not display the coin toss result with each flip, but instead display percentages of the heads and tails after the 1,000 coin tosses are complete. Save the file as **FlipCoin2.java**.
10.
    - a. Create a class named `Purchase`. Each `Purchase` contains an invoice number, amount of sale, and amount of sales tax. Include set methods for the invoice number and sale amount. Within the `set()` method for the sale amount, calculate the sales tax as 5% of the sale amount. Also include a display method that displays a purchase’s details. Save the file as **Purchase.java**.
    - b. Create an application that declares a `Purchase` object and prompts the user for purchase details. When you prompt for an invoice number, do not let the user proceed until a number between 1,000 and 8,000 has been entered. When you prompt for a sale amount, do not proceed until the user has entered a nonnegative value. After a valid `Purchase` object has been created, display the object’s invoice number, sale amount, and sales tax. Save the file as **CreatePurchase.java**.
  11. Create a `Delivery` class for a delivery service. The class contains fields to hold the following:
    - ♦ A delivery number that contains eight digits. The first four digits represent the year, and the last four digits represent the delivery number. For example, the 76th delivery in 2011 has a complete delivery number of 20110076.
    - ♦ A code representing the delivery area. A local delivery is code 1, and a long-distance delivery is code 2.
    - ♦ A weight, in pounds, of the item to be delivered.
    - ♦ The fee for the delivery, as follows:

| Distance | Weight           | Fee (\$) |
|----------|------------------|----------|
| 1        | Under 5 pounds   | 12.00    |
| 1        | 5 to 20 pounds   | 16.50    |
| 1        | Over 20 pounds   | 22.00    |
| 2        | Under 5 pounds   | 35.00    |
| 2        | 5 pounds or more | 47.95    |

Create a constructor for the `Delivery` class that accepts arguments for the year, delivery number within the year, delivery distance code, and weight of the package. The constructor determines the eight-digit delivery number and delivery fee. Also include a method that displays every `Delivery` object field. Save the file as **Delivery.java**.

Next, create an application that prompts the user for data for a delivery. Keep prompting the user for each of the following values until they are valid:

- A four-digit year between 2001 and 2025 inclusive
- A delivery number for the year between 1 and 9999 inclusive
- A package weight between 0.10 pound and 100 pounds inclusive
- A delivery distance code that is either 1 or 2

When all the data entries are valid, construct a `Delivery` object, and then display its values. Save the file as **CreateDelivery.java**.



## Debugging Exercise

12. Each of the following files in the `Chapter.06` folder of your downloadable student files has syntax and/or logic errors. In each case, determine the problem and fix the program. After you correct the errors, save each file using the same filename preceded with `Fix`. For example, save `DebugSix1.java` as `FixDebugSix1.java`.
  - a. `DebugSix1.java`
  - b. `DebugSix2.java`
  - c. `DebugSix3.java`
  - d. `DebugSix4.java`



## Game Zone

13.
  - a. Write an application that creates a quiz. The quiz should contain at least five questions about a hobby, popular music, astronomy, or any other personal interest. Each question should be a multiple-choice question with at least four answer options. When the user answers the question correctly, display a congratulatory message. If the user responds to a question incorrectly, display an appropriate message as well as the correct answer. At the end of the quiz, display the number of correct and incorrect answers, and the percentage of correct answers. Save the file as **Quiz.java**.
  - b. Modify the `Quiz` application so that the user is presented with each question continually until it is answered correctly. Remove the calculation for percentage of correct answers—all users will have 100% correct by the time they complete the application. Save the file as **Quiz2.java**.
14. In Chapter 1, you created a class called `RandomGuess`. In this game, players guess a number, the application generates a random number, and players determine whether they were correct. In Chapter 5, you improved the application to display a message indicating whether the player's guess was correct, too high, or too low. Now, add a loop

that continuously prompts the user for the number, indicating whether the guess is high or low, until the user enters the correct value. After the user correctly guesses the number, display a count of the number of attempts it took. Save the file as **RandomGuess3.java**.

15. In Chapter 4, you created a `Die` class from which you could instantiate an object containing a random value from 1 through 6. Now use the class to create a simple dice game in which the user chooses a number between 2 (the lowest total possible from two dice) and 12 (the highest total possible). The user “rolls” two dice up to three times. If the number chosen by the user comes up, the user wins and the game ends. If the number does not come up within three rolls, the computer wins. Save the application as **TwoDice3.java**.
16. a. Using the `Die` class you created in Chapter 4, create a version of the dice game Pig that a user can play against the computer. The object of the game is to be the first to score 100 points. The user and computer take turns rolling a pair of dice following these rules:
  - ♦ On a turn, each player “rolls” two dice. If no 1 appears, the dice values are added to a running total, and the player can choose whether to roll again or pass the turn to the other player.
  - ♦ If a 1 appears on one of the dice, nothing more is added to the player’s total and it becomes the other player’s turn.
  - ♦ If a 1 appears on both of the dice, not only is the player’s turn over, but the player’s entire accumulated score is reset to 0.
  - ♦ In this version of the game, when the computer does not roll a 1 and can choose whether to roll again, generate a random value between 0 and 1. Have the computer continue to roll the dice when the value is 0.5 or more, and have the computer quit and pass the turn to the player when the value is not 0.5 or more.

Save the game as **PigDiceGame.java**.

- b. Modify the `PigDiceGame` application so that if a player rolls a 1, not only does the player’s turn end, but all the player’s earned points during that round are eliminated. (Points from earlier rounds are not affected.) Save the game as **PigDiceGame2.java**.

*This page intentionally left blank*

# Characters, Strings, and the StringBuilder

In this chapter, you will:

- ⦿ Identify string data problems
- ⦿ Manipulate characters
- ⦿ Declare and compare `String` objects
- ⦿ Use other `String` methods
- ⦿ Convert `Strings` to numbers
- ⦿ Use the `StringBuilder` and `StringBuffer` classes

## Understanding String Data Problems

Manipulating characters and groups of characters provides some challenges for the beginning Java programmer. For example, consider the TryToCompareStrings application shown in Figure 7-1. The main() method declares a String named aName and assigns “Carmen” to it. The user is then prompted to enter a name. The application compares the two names using the equivalency operator ( == ) and displays one of two messages indicating whether the strings are equivalent.

```
import java.util.Scanner;
public class TryToCompareStrings
{
    public static void main(String[] args)
    {
        String aName = "Carmen";
        String anotherName;
        Scanner input = new Scanner(System.in);
        System.out.print("Enter your name > ");
        anotherName = input.nextLine();
        if(aName == anotherName)
            System.out.println(aName + " equals " + anotherName);
        else
            System.out.println(aName + " does not equal " + anotherName);
    }
}
```

**Don't Do It**  
Do not use == to compare Strings' contents.

Figure 7-1 The TryToCompareStrings application

Figure 7-2 shows the execution of the application. When the user types “Carmen” as the value for anotherName, the application concludes that the two names are not equal.



```
CA. Command Prompt
C:\Java>java TryToCompareStrings
Enter your name > Carmen
Carmen does not equal Carmen
C:\Java>
```

Figure 7-2 Execution of the TryToCompareStrings application



The application in Figure 7-1 seems to produce incorrect results. The problem stems from the fact that in Java `String` is a class, and each created `String` is a class object. As an object, a `String` variable name is not a simple data type—it is a **reference**; that is, a variable that holds a memory address. Therefore, when you compare two `Strings` using the `==` operator, you are not comparing their values, but their computer memory locations.

Programmers want to compare the contents of memory locations (the values stored there) more frequently than they want to compare the locations themselves (the addresses). Fortunately, the creators of Java have provided three classes that you can use when working with text data; these classes provide you with many methods that make working with characters and strings easier:

- **Character**—A class whose instances can hold a single character value. This class also defines methods that can manipulate or inspect single-character data.
- **String**—A class for working with fixed-string data—that is, unchanging data composed of multiple characters.
- **StringBuilder** and **StringBuffer**—Classes for storing and manipulating changeable data composed of multiple characters.

## TWO TRUTHS & A LIE

### Understanding String Data Problems

1. A `String` is a simple data type that can hold text data.
2. Programmers want to compare the values of `Strings` more frequently than they want to compare their memory addresses.
3. `Character`, `String`, and `StringBuilder` are useful built-in classes for working with text data.

The false statement is #1. A `String` variable name is a reference; that is, it holds a memory address.

## Manipulating Characters

You learned in Chapter 2 that the `char` data type is used to hold any single character—for example, letters, digits, and punctuation marks. In addition to the primitive data type `char`, Java offers a `Character` class. The `Character` class contains standard methods for testing the values of characters. Table 7-1 describes many of the `Character` class methods. The methods that begin with “is”, such as `isUpperCase()`, return a Boolean value that can be used in comparison statements; the methods that begin with “to”, such as `toUpperCase()`, return a character that has been converted to the stated format.

| Method                         | Description                                                                                                                                                     |
|--------------------------------|-----------------------------------------------------------------------------------------------------------------------------------------------------------------|
| <code>isUpperCase()</code>     | Tests if character is uppercase                                                                                                                                 |
| <code>toUpperCase()</code>     | Returns the uppercase equivalent of the argument; no change is made if the argument is not a lowercase letter                                                   |
| <code>isLowerCase()</code>     | Tests if character is lowercase                                                                                                                                 |
| <code>toLowerCase()</code>     | Returns the lowercase equivalent of the argument; no change is made if the argument is not an uppercase letter                                                  |
| <code>isDigit()</code>         | Returns <code>true</code> if the argument is a digit (0–9) and <code>false</code> otherwise                                                                     |
| <code>isLetter()</code>        | Returns <code>true</code> if the argument is a letter and <code>false</code> otherwise                                                                          |
| <code>isLetterOrDigit()</code> | Returns <code>true</code> if the argument is a letter or digit and <code>false</code> otherwise                                                                 |
| <code>isWhitespace()</code>    | Returns <code>true</code> if the argument is whitespace and <code>false</code> otherwise; this includes the space, tab, newline, carriage return, and form feed |

**Table 7-1** Commonly used methods of the `Character` class



The `Character` class is defined in `java.lang` and is automatically imported into every program you write. The `Character` class inherits from `java.lang.Object`. You will learn more about the `Object` class when you study inheritance concepts in the chapter *Introduction to Inheritance*.

Figure 7-3 contains an application that uses many of the methods shown in Table 7-1. The application asks a user to enter a character. A `String` is accepted and the `charAt()` method is used to extract the first character in the user-entered `String`. (The `charAt()` method belongs to the `String` class; you will learn more about this class and method later in this chapter.) The application determines the attributes of the character and displays information about it.



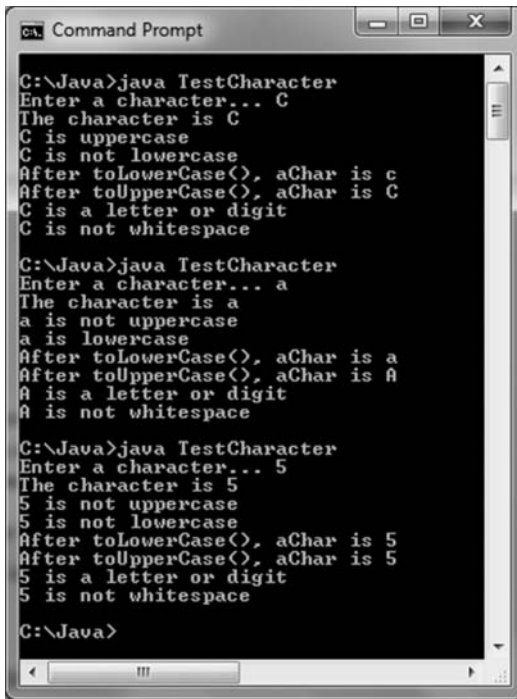
You can tell that each of the `Character` class methods used in the `TestCharacter` application in Figure 7-3 is a static method because the method name is used without an object reference—you use only the class name, a dot, and the method name. You learned about the difference between static and instance methods in Chapter 3.

```
import java.util.Scanner;
public class TestCharacter
{
    public static void main(String[] args)
    {
        char aChar;
        String aString;
        Scanner keyboard = new Scanner(System.in);
        System.out.print("Enter a character... ");
        aString = keyboard.nextLine();
        aChar = aString.charAt(0);
        System.out.println("The character is " + aChar);
        if(Character.isUpperCase(aChar))
            System.out.println(aChar + " is uppercase");
        else
            System.out.println(aChar + " is not uppercase");
        if(Character.isLowerCase(aChar))
            System.out.println(aChar + " is lowercase");
        else
            System.out.println(aChar + " is not lowercase");
        aChar = Character.toLowerCase(aChar);
        System.out.println("After toLowerCase(), aChar is " + aChar);
        aChar = Character.toUpperCase(aChar);
        System.out.println("After toUpperCase(), aChar is " + aChar);
        if(Character.isLetterOrDigit(aChar))
            System.out.println(aChar + " is a letter or digit");
        else
            System.out.println(aChar +
                " is neither a letter nor a digit");
        if(Character.isWhitespace(aChar))
            System.out.println(aChar + " is whitespace");
        else
            System.out.println(aChar + " is not whitespace");
    }
}
```

**Figure 7-3** The TestCharacter application

The output of three typical executions of the TestCharacter application is shown in Figure 7-4. For example, notice that when the character “C” is tested, you can see the following:

- The value returned by the `isUpperCase()` method is `true`.
- The value returned by the `isLowerCase()` method is `false`.
- The value returned by the `toLowerCase()` method is `'c'`.
- The value returned by the `toUpperCase()` method is `'C'`.
- The value returned by the `isLetterOrDigit()` method is `true`.
- The value returned by the `isWhitespace()` method is `false`.



```
C:\Java>java TestCharacter
Enter a character... C
The character is C
C is uppercase
C is not lowercase
After toLowerCase(), aChar is c
After toUpperCase(), aChar is C
C is a letter or digit
C is not whitespace

C:\Java>java TestCharacter
Enter a character... a
The character is a
a is not uppercase
a is lowercase
After toLowerCase(), aChar is a
After toUpperCase(), aChar is A
A is a letter or digit
A is not whitespace

C:\Java>java TestCharacter
Enter a character... 5
The character is 5
5 is not uppercase
5 is not lowercase
After toLowerCase(), aChar is 5
After toUpperCase(), aChar is 5
5 is a letter or digit
5 is not whitespace

C:\Java>
```

Figure 7-4 Three typical executions of the TestCharacter application

## TWO TRUTHS & A LIE

### Manipulating Characters

1. Character is a class, but char is a simple data type.
2. The Character class method `isLowerCase()` returns the lowercase version of any uppercase character.
3. If a char variable holds the Unicode value for the Tab key, `isWhitespace()` would be true and `isLetterOrDigit()` would be false.

The false statement is #2. The Character class method `toLowerCase()` returns true or false, as do all the Character class methods whose names use the `is` prefix.

## Declaring and Comparing String Objects

You learned in Chapter 1 that a sequence of characters enclosed within double quotation marks is a literal string. (Programmers might also call it a “string literal.”) You have used many literal strings, such as “First Java application”, and you have assigned values to `String` objects and used them within methods, such as `println()` and `showMessageDialog()`. A literal string is an unnamed object, or **anonymous object**, of the `String` class, and a **String variable** is simply a named object of the same class. The class `String` is defined in `java.lang.String`, which is automatically imported into every program you write.



You have declared a `String` array named `args` in every `main()` method header that you have written. You will learn about arrays in the next chapter.

When you declare a `String` object, the `String` itself—that is, the series of characters contained in the `String`—is distinct from the identifier you use to refer to it. You can create a `String` object by using the keyword `new` and the `String` constructor, just as you would create an object of any other type. For example, the following statement defines an object named `aGreeting`, declares it to be of type `String`, and assigns an initial value of “Hello” to the `String`:

```
String aGreeting = new String("Hello");
```

The variable `aGreeting` stores a reference to a `String` object—it keeps track of where the `String` object is stored in memory. When you declare and initialize `aGreeting`, it links to the initializing `String` value. Because strings are declared so routinely in programs, Java provides a shortcut, so you can declare a `String` containing “Hello” with the following statement that omits the keyword `new` and does not explicitly call the class constructor:

```
String aGreeting = "Hello";
```



If you declare two `String` objects and initialize both to the same value, the value is stored only once in memory and the two object references hold the same memory address. Because the character string is stored just once, memory is saved.

## Comparing String Values

In Java, `String` is a class, and each created `String` is a class object. A `String` variable name is a reference; that is, a `String` variable name refers to a location in memory, rather than to a particular value.

308

The distinction is subtle, but when you declare a variable of a basic, primitive type, such as `int x = 10;`, the memory address where `x` is located holds the value 10. If you later assign a new value to `x`, the new value replaces the old one at the assigned memory address. For example, if you code `x = 45;`, then 45 replaces 10 at the address of `x`.

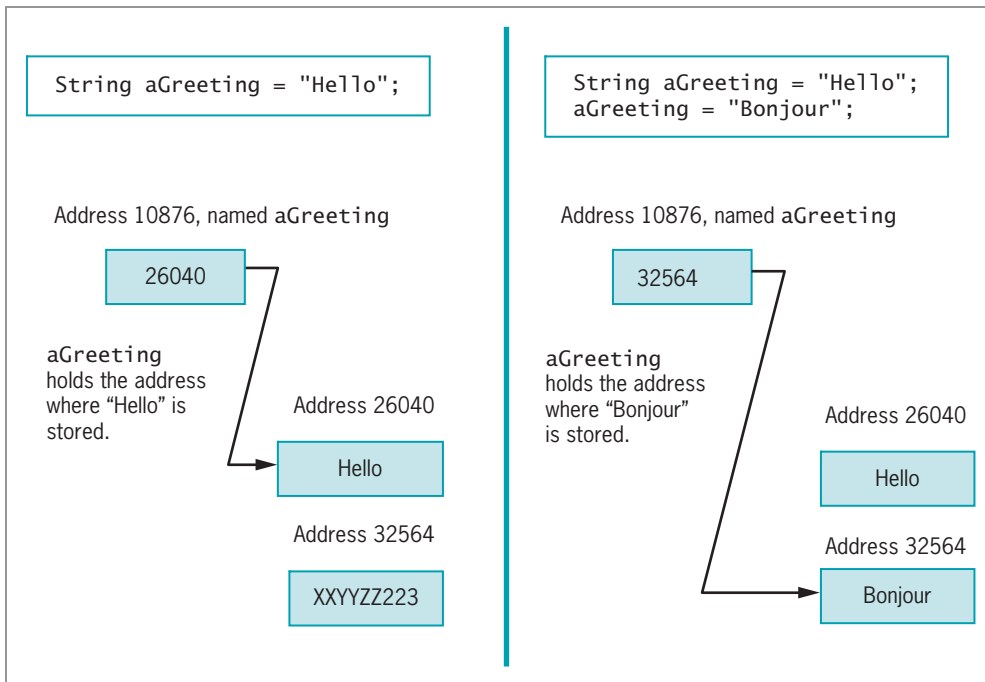
In contrast, when you declare a `String`, such as `String aGreeting = "Hello";`, `aGreeting` does not hold the characters "Hello"; instead it holds a memory address where the characters are stored.

The left side of Figure 7-5 shows a diagram of computer memory if `aGreeting` happens to be stored at memory address 10876 and the `String` "Hello" happens to be stored at memory address 26040. When you refer to `aGreeting`, you actually are accessing the address of the characters you want to use. (In the example in Figure 7-5, the memory location beginning at address 32564 has not yet been used and holds garbage values.)



You cannot choose the memory address where a value is stored. Addresses such as 10876 are chosen by the operating system.

If you subsequently assign a new value to `aGreeting`, such as `aGreeting = "Bonjour";`, the address held by `aGreeting` is altered; now, `aGreeting` holds a new address where the characters "Bonjour" are stored. As shown on the right side of Figure 7-5, "Bonjour" is an entirely new object created with its own location. The "Hello" `String` is still in memory, but `aGreeting` no longer holds its address. Eventually, a part of the Java system called the garbage collector discards the "Hello" characters. `Strings`, therefore, are never actually changed; instead, new `Strings` are created and `String` references hold the new addresses. `Strings` and other objects that can't be changed are **immutable**.



**Figure 7-5** Contents of `aGreeting` at declaration and after an assignment

Because `String` references hold memory addresses, making simple comparisons between them often produces misleading results. For example, recall the `TryToCompareStrings` application in Figure 7-1. In this example, Java evaluates the `String` variables `aName` and `anotherName` as not equal because even though the variables contain the same series of characters, one set is assigned directly and the other is entered from the keyboard and stored in a different area of memory. When you compare `Strings` with the `==` operator, you are comparing their memory addresses, not their values. Furthermore, when you try to compare `Strings` using the less-than (`<`) or greater-than (`>`) operator, the program will not even compile.

Fortunately, the `String` class provides you with a number of useful methods. The `String` class **`equals()` method** evaluates the contents of two `String` objects to determine if they are equivalent. The method returns `true` if the objects have identical contents. For example, Figure 7-6 shows a `CompareStrings` application, which is identical to the `TryToCompareStrings` application in Figure 7-1 except for the shaded comparison.

```
import java.util.Scanner;
public class CompareStrings
{
    public static void main(String[] args)
    {
        String aName = "Carmen";
        String anotherName;
        Scanner input = new Scanner(System.in);
        System.out.print("Enter your name > ");
        anotherName = input.nextLine();
        if(aName.equals(anotherName))
            System.out.println(aName + " equals " + anotherName);
        else
            System.out.println(aName + " does not equal " + anotherName);
    }
}
```

Figure 7-6 The CompareStrings application

When a user runs the CompareStrings application and enters “Carmen” for the name, the output appears as shown in Figure 7-7; the contents of the Strings are equal. The String class equals() method returns true only if two Strings are identical in content. Thus, a String that refers to “Carmen ” (with a space after the “n”) is not equivalent to a String that refers to “Carmen” (with no space after the “n”).



Figure 7-7 Output of the CompareStrings application



Technically, the equals() method does not perform an alphabetical comparison with Strings; it performs a **lexicographical comparison**—a comparison based on the integer Unicode values of the characters.

Each String declared in Figure 7-6 (aName and anotherName) is an object of type String, so each String has access to the String class equals() method. If you analyze how the



`equals()` method is used in the application in Figure 7-6, you can tell quite a bit about how the method was written by Java's creators:

- Because you use the `equals()` method with a `String` object and the method uses the unique contents of that object to make a comparison, you can tell that it is not a static method.
- Because the call to the `equals()` method can be used in an `if` statement, you can tell that it returns a `Boolean` value.
- Because you see a `String` used between the parentheses in the method call, you can tell that the `equals()` method takes a `String` argument.

So, the method header of the `equals()` method within the `String` class must be similar to the following:

```
public boolean equals(String s)
```

The only thing you do not know about the method header is the local name used for the `String` argument—it might be `s`, or it might be any other legal Java identifier. When you use a prewritten method such as `equals()`, you do not know how the code looks inside it. For example, you do not know whether the `equals()` method compares the characters in the `Strings` from left to right or from right to left. All you know is that the method returns `true` if the two `Strings` are completely equivalent and `false` if they are not.

Because both `aName` and `anotherName` are `Strings` in the application in Figure 7-6, the `aName` object can call `equals()` with `aName.equals(anotherName)` as shown, or the `anotherName` object could call `equals()` with `anotherName.equals(aName)`. The `equals()` method can take either a variable `String` object or a literal string as its argument. The `String` class **`equalsIgnoreCase()` method** is similar to the `equals()` method. As its name implies, this method ignores case when determining if two `Strings` are equivalent. Thus, if you declare a `String` as `String aName = "Carmen";`, then `aName.equals("caRMen")` is `false`, but `aName.equalsIgnoreCase("caRMen")` is `true`. This method is useful when users type responses to prompts in your programs. You cannot predict when a user might use the Shift key or the Caps Lock key during data entry.

When the `String` class **`compareTo()` method** is used to compare two `Strings`, it provides additional information to the user in the form of an integer value. When you use `compareTo()` to compare two `String` objects, the method returns zero only if the two `Strings` refer to the same value. If there is any difference between the `Strings`, a negative number is returned if the calling object is “less than” the argument, and a positive number is returned if the calling object is “more than” the argument. `Strings` are considered “less than” or “more than” each other based on their Unicode values; thus, “a” is less than “b”, and “b” is less than “c”. For example, if `aName` refers to “Roger”, then `aName.compareTo("Robert");` returns a 5. The number is positive, indicating that “Roger” is more than “Robert”. This does not mean that “Roger” has more characters than “Robert”; it means that “Roger” is alphabetically “more” than “Robert”. The comparison proceeds as follows:

- The R in “Roger” and the R in “Robert” are compared, and found to be equal.
- The o in “Roger” and the o in “Robert” are compared, and found to be equal.
- The g in “Roger” and the b in “Robert” are compared; they are different. The numeric value of g minus the numeric value of b is 5 (because g is five letters after b in the alphabet), so the `compareTo()` method returns the value 5.

Often, you won't care what the specific return value of `compareTo()` is; you simply want to determine if it is positive or negative. For example, you can use a test such as `if(aWord.compareTo(anotherWord) < 0)...` to determine whether `aWord` is alphabetically less than `anotherWord`. If `aWord` is a `String` variable that refers to the value “hamster”, and `anotherWord` is a `String` variable that refers to the value “iguana”, the comparison `if(aWord.compareTo(anotherWord) < 0)` yields `true`.



Watch the video *Comparing Strings*.

## TWO TRUTHS & A LIE

### Declaring and Comparing String Objects

1. To create a `String` object, you must use the keyword `new` and explicitly call the class constructor.
2. When you compare `Strings` with the `==` operator, you are comparing their memory addresses, not their values.
3. When you compare `Strings` with the `equals()` method, you are comparing their values, not their memory addresses.

The false statement is #1. You can create a `String` object with or without the keyword `new` and without explicitly calling the `String` constructor.

## Using Other String Methods

A wide variety of additional methods are available with the `String` class. The methods `toUpperCase()` and `toLowerCase()` convert any `String` to its uppercase or lowercase equivalent. For example, if you declare a `String` as `String aWord = "something";`, then the string “something” is created in memory and its address is assigned to `aWord`. The statement `aWord = aWord.toUpperCase()` creates “SOMETHING” in memory and assigns its address to `aWord`. Because `aWord` now refers to “SOMETHING,” `aWord = aWord.toLowerCase()` alters `aWord` to refer to “something”.

The **length() method** returns the length of a `String`. For example, the following statements result in the variable `len` that holds the value 5.

```
String greeting = "Hello";
int len = greeting.length();
```



Methods that return information about an object are called **accessor methods**. The `length()` method is an example of an accessor method.



When you must determine whether a `String` is empty, it is more efficient to compare its length to 0 than it is to use the `equals()` method.

The **indexOf() method** determines whether a specific character occurs within a `String`. If it does, the method returns the position of the character; the first position of a `String` is zero. The return value is `-1` if the character does not exist in the `String`. For example, in `String myName = "Stacy";`, the value of `myName.indexOf('S')` is 0, the value of `myName.indexOf('a')` is 2, and the value of `myName.indexOf('q')` is `-1`.

The **charAt() method** requires an integer argument that indicates the position of the character that the method returns. For example, if `myName` is a `String` that refers to “Stacy”, the value of `myName.charAt(0)` is ‘S’ and the value of `myName.charAt(1)` is ‘t’.

The **endsWith() method** and the **startsWith() method** each take a `String` argument and return `true` or `false` if a `String` object does or does not end or start with the specified argument. For example, if `String myName = "Stacy";`, then `myName.startsWith("Sta")` is `true`, and `myName.endsWith("z")` is `false`.

The **replace() method** allows you to replace all occurrences of some character within a `String`. For example, if `String yourName = "Annette";`, then `String goofyName = yourName.replace('n', 'X');` assigns “AXXette” to `goofyName`.

Although not part of the `String` class, the **toString() method** is useful when working with `String` objects. It converts any object to a `String`. In particular, it is useful when you want to convert primitive data types to `Strings`. So, if you declare `theString` and `someInt = 4;`, as follows, then after the following statements, `theString` refers to “4”:

```
String theString;
int someInt = 4;
theString = Integer.toString(someInt);
```

If you declare another `String` and a `double` as follows, then after the following statements, `aString` refers to “8.25”:

```
String aString;
double someDouble = 8.25;
aString = Double.toString(someDouble);
```

You also can use **concatenation** to convert any primitive type to a `String`. You can join a simple variable to a `String`, creating a longer `String` using the `+` operator. For example, if you declare a variable as `int myAge = 25;`, the following statement results in `aString` that refers to “My age is 25”:

```
String aString = "My age is " + myAge;
```

Similarly, if you write the following, then `anotherString` refers to "12.34".

```
String anotherString;  
float someFloat = 12.34f;  
anotherString = "" + someFloat;
```

The Java interpreter first converts the float `12.34f` to a `String` "12.34" and adds it to the null `String` "".



The `toString()` method does not originate in the `String` class; it is a method included in Java that you can use with any type of object. In the chapter *Advanced Inheritance Concepts*, you will learn how to construct versions of the method for your own classes and that `toString()` originates in the `Object` class. You have been using `toString()` throughout this book without knowing it. When you use `print()` and `println()`, their arguments are automatically converted to `Strings` if necessary. You don't need import statements to use `toString()` because it is part of `java.lang`, which is imported automatically. Because the `toString()` method you use with `println()` takes arguments of any primitive type, including `int`, `char`, `double`, and so on, it is a working example of polymorphism.

You already know that you can concatenate `Strings` with other `Strings` or values by using a plus sign (+); you have used this approach in methods such as `println()` and `showMessageDialog()` since Chapter 1. For example, you can display a `firstName`, a space, and a `lastName` with the following statement:

```
System.out.println(firstName + " " + lastName);
```

In addition, you can extract part of a `String` with the **`substring()` method**, and use it alone or concatenate it with another `String`. The `substring()` method takes two integer arguments—a start position and an end position—that are both based on the fact that a `String`'s first position is position zero. The length of the extracted substring is the difference between the second integer and the first integer; if you write the method without a second integer, the substring extends to the end of the original string.

For example, the application in Figure 7-8 prompts the user for a customer's first and last names. The application then extracts these names so that a friendly business letter can be constructed. After the application prompts the user to enter a name, a loop control variable is initialized to 0. While the variable remains less than the length of the entered name, each character is compared to the space character. When a space is found, two new strings are created. The first, `firstName`, is the substring of the original entry from position 0 to the location where the space was found. The second, `familyName`, is the substring of the original entry from the position after the space to the end of the string. Once the first and last names have been created, the loop control variable is set to the length of the original string so the loop will exit and proceed to the display of the friendly business letter. Figure 7-9 shows the data entry screen as well as the output letter created.

```
import javax.swing.*;
public class BusinessLetter
{
    public static void main(String[] args)
    {
        String name;
        String firstName = "";
        String familyName = "";
        int x;
        char c;
        name = JOptionPane.showInputDialog(null,
            "Please enter customer's first and last name");
        x = 0;
        while(x < name.length())
        {
            if(name.charAt(x) == ' ')
            {
                firstName = name.substring(0, x);
                familyName = name.substring(x + 1, name.length());
                x = name.length();
            }
            ++x;
        }
        JOptionPane.showMessageDialog(null,
            "Dear " + firstName +
            ",\nI am so glad we are on a first name basis" +
            "\nbecause I would like the opportunity to" +
            "\ntalk to you about an affordable insurance" +
            "\nprotection plan for the entire " + familyName +
            "\nfamily. Call A-One Family Insurance today" +
            "\nat 1-800-555-9287.");
    }
}
```

**Figure 7-8** The BusinessLetter application



To keep the example simple, the `BusinessLetter` application in Figure 7-8 displays a letter for just one customer. An actual business application would most likely allow a clerk to enter dozens or even hundreds of customer names and store them in a data file for future use. You will learn to store data permanently in files in the chapter *File Input and Output*. For now, just concentrate on the string-handling capabilities of the application.

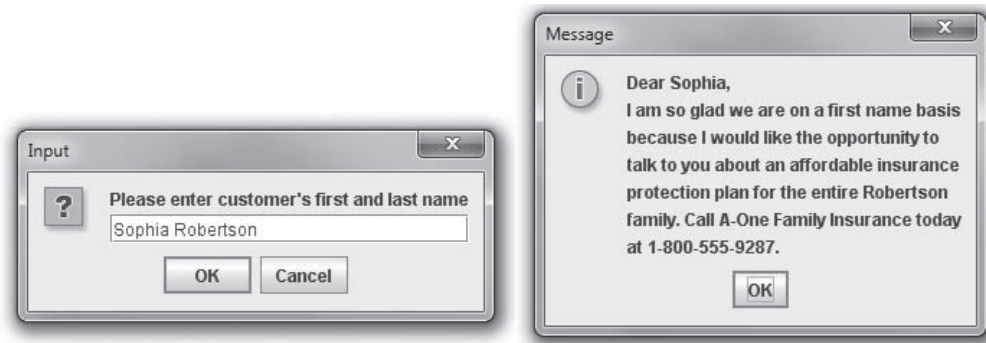


Figure 7-9 Typical execution of the BusinessLetter application

## TWO TRUTHS & A LIE

### Using Other String Methods

1. Assume `myName` is a `String` defined as “molly”. The value of `myName.toUpperCase()` is “Molly”.
2. Assume `myName` is a `String` defined as “molly”. The value of `myName.length()` is 5.
3. Assume `myName` is a `String` defined as “molly”. The value of `myName.indexOf('M')` is `-1`.

The false statement is #1. If `myName` is “molly”, then `myName.toUpperCase()` is “MOLLY”.

## Converting Strings to Numbers

If a `String` contains all numbers, as in “649,” you can convert it from a `String` to a number so you can use it for arithmetic, or use it like any other number. For example, suppose you ask a user to enter a salary in an input dialog box. When you accept input using `showInputDialog()`, the accepted value is always a `String`. To be able to use the value in arithmetic statements, you must convert the `String` to a number.



When you use any of the methods described in this section to attempt to convert a `String` to a number, but the `String` does not represent a valid number (for example, if it contains letters), or the `String` represents the wrong kind of number (for example, it contains a decimal point but is being converted to an integer), an error called a `NumberFormatException` occurs. You will learn about exceptions in the chapter *Exception Handling*.

To convert a `String` to an integer, you use the **Integer class**, which is part of `java.lang` and is automatically imported into programs you write. The `Integer` class is an example of a wrapper. A **wrapper** is a class or object that is “wrapped around” a simpler element; the `Integer` wrapper class contains a simple integer and useful methods to manipulate it. You have already used the **`parseInt()` method**, which is part of the `Integer` class; it takes a `String` argument and returns its integer value. For example, `int anInt = Integer.parseInt("649");` stores the numeric value 649 in the variable `anInt`. You can then use the integer value just as you would any other integer.



The word “parse” in English means “to resolve into component parts,” as when you parse a sentence. In Java, to parse a `String` means to break down its separate characters into a numeric format.

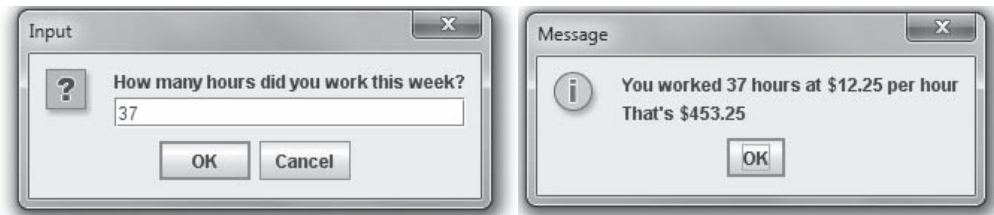


You can tell `parseInt()` is a `static` method because you use it with the class name and not with an object.

Alternatively, you can use the `Integer` class `valueOf()` method to convert a `String` to an `Integer` class object, and then use the `Integer` class `intValue()` method to extract the simple integer from its wrapper class. The `ConvertStringToInteger` application in Figure 7-10 shows how you can accomplish the conversion. When the user enters a `String` in the `showInputDialog()` method, the `String` is stored in `stringHours`. The application then uses the `valueOf()` method to convert the `String` to an `Integer` object, and uses the `intValue()` method to extract the integer. When the user enters “37” as the `String`, it is converted to a number that can be used in a mathematical statement, and the output appears as expected; this output is shown in Figure 7-11.

```
import javax.swing.JOptionPane;
public class ConvertStringToInteger
{
    public static void main(String[] args)
    {
        String stringHours;
        int hours;
        Integer integerHours;
        final double PAY_RATE = 12.25;
        stringHours = JOptionPane.showInputDialog(null,
            "How many hours did you work this week?");
        integerHours = Integer.valueOf(stringHours);
        hours = integerHours.intValue();
        JOptionPane.showMessageDialog(null, "You worked " +
            hours + " hours at $" + PAY_RATE + " per hour" +
            "\nThat's $" + (hours * PAY_RATE));
    }
}
```

**Figure 7-10** The `ConvertStringToInteger` application



**Figure 7-11** Typical execution of the `ConvertStringToInteger` application

It is also easy to convert a `String` object to a `double` value. You must use the **`Double` class**, which, like the `Integer` class, is a wrapper class and is imported into your programs automatically. The `Double` class **`parseDouble()` method** takes a `String` argument and returns its `double` value. For example, the following statement stores the numeric value 147.82 in the variable `doubleValue`.

```
double doubleValue = Double.parseDouble("147.82");
```

To convert a `String` containing "147.82" to a `double`, you also can use the following code:

```
String stringValue = new String("147.82");  
Double tempValue = Double.valueOf(stringValue);  
double value = tempValue.doubleValue();
```

In this example, `stringValue` is passed to the `Double.valueOf()` method, which returns a `Double` object. The `doubleValue()` method is used with the `tempValue` object; this method returns a simple `double` that is stored in `value`.



The methods `parseInt()` and `parseDouble()` are newer than the `valueOf()` methods, and many programmers prefer to use them when writing new applications.



Besides `Double` and `Integer`, other wrapper classes such as `Float` and `Long` also provide `valueOf()` methods that convert `Strings` to the wrapper types. Additionally, the classes provide `parseFloat()` and `parseLong()` methods, respectively.



Watch the video *String Methods*.



**TWO TRUTHS & A LIE****Converting Strings to Numbers**

1. The `Integer` and `Double` classes are wrapper classes.
2. The value of `Integer.parseInt("22.22")` is 22.
3. The value of `Double.parseDouble("22.22")` is 22.22.

The false statement is #2. `Integer.parseInt("22.22")` does not work because the `String` argument to the `parseInt()` method cannot be converted to an `Integer`.

319

## Learning About the `StringBuilder` and `StringBuffer` Classes

In Java, the value of a `String` is fixed after the `String` is created; `Strings` are immutable, or unchangeable. When you write `someString = "Hello";` and follow it with `someString = "Goodbye";`, you have neither changed the contents of computer memory at the address represented by `someString` nor eliminated the characters “Hello”. Instead, you have stored “Goodbye” at a new computer memory location and stored the new address in the `someString` variable. If you want to modify `someString` from “Goodbye” to “Goodbye Everybody”, you cannot add a space and “Everybody” to the `someString` that contains “Goodbye”. Instead, you must create an entirely new `String`, “Goodbye Everybody”, and assign it to the `someString` address.

To circumvent these limitations, you can use either the `StringBuilder` or `StringBuffer` class. You use one of these classes, which are alternatives to the `String` class, when you know a `String` will be modified; usually, you can use a `StringBuilder` or `StringBuffer` object anywhere you would use a `String`. Like the `String` class, these two classes are part of the `java.lang` package and are automatically imported into every program. The classes are identical except for the following:

- `StringBuilder` is more efficient.
- `StringBuffer` is thread safe. This means you should use it in applications that run multiple threads, which are paths of control taken during program execution. Because most programs you write (and all the programs you have written so far) contain a single thread, usually you should use `StringBuilder`.

The rest of this section discusses `StringBuilder`, but every statement is also true of `StringBuffer`.

You can create a `StringBuilder` object that contains a `String` with a statement such as the following:

```
StringBuilder message = new StringBuilder("Hello there");
```

When you create a `String`, you have the option of omitting the keyword `new`, but when you initialize a `StringBuilder` object you must use the keyword `new`, the constructor name, and

an initializing value between the constructor's parentheses. You can create an empty `StringBuilder` variable using a statement such as the following:

```
StringBuilder uninitializedString = null;
```

The variable does not refer to anything until you initialize it with a defined `StringBuilder` object. Generally, when you create a `String` object, sufficient memory is allocated to accommodate the number of Unicode characters in the string. A `StringBuilder` object, however, contains a memory block called a **buffer**, which might or might not contain a string. Even if it does contain a string, the string might not occupy the entire buffer. In other words, the length of a string can be different from the length of the buffer. The actual length of the buffer is the **capacity** of the `StringBuilder` object.

You can change the length of a string in a `StringBuilder` object with the **`setLength()` method**. The **length property** is an attribute of the `StringBuilder` class that identifies the number of characters in the `String` contained in the `StringBuilder`. When you increase a `StringBuilder` object's length to be longer than the `String` it holds, the extra characters contain `'\u0000'`. If you use the `setLength()` method to specify a length shorter than its `String`, the string is truncated.

To find the capacity of a `StringBuilder` object, you use the **`capacity()` method**. The `StringBuilderDemo` application in Figure 7-12 demonstrates this method. The application creates a `nameString` object containing the seven characters "Barbara". The capacity of the `StringBuilder` object is obtained and stored in an integer variable named `nameStringCapacity` and displayed.

```
import javax.swing.JOptionPane;
public class StringBuilderDemo
{
    public static void main(String[] args)
    {
        StringBuilder nameString = new StringBuilder("Barbara");
        int nameStringCapacity = nameString.capacity();
        System.out.println("Capacity of nameString is " +
            nameStringCapacity);
        StringBuilder addressString = null;
        addressString = new
            StringBuilder("6311 Hickory Nut Grove Road");
        int addStringCapacity = addressString.capacity();
        System.out.println("Capacity of addressString is " +
            addStringCapacity);
        nameString.setLength(20);
        System.out.println("The name is " + nameString + "end");
        addressString.setLength(20);
        System.out.println("The address is " + addressString);
    }
}
```

**Figure 7-12** The `StringBuilderDemo` application

Figure 7-13 shows the `StringBuilder` capacity is 23, which is 16 characters more than the length of the string “Barbara”. Whenever you create a `StringBuilder` object, its capacity is the length of the `String` contained in `StringBuilder`, plus 16. The “extra” 16 positions allow for reasonable modification of the `StringBuilder` object after creation without allocating any new memory locations.



```

C:\Java>java StringBuilderDemo
Capacity of nameString is 23
Capacity of addressString is 43
The name is Barbara      end
The address is 6311 Hickory Nut Gro
C:\Java>

```

**Figure 7-13** Output of the `StringBuilderDemo` application



The creators of Java chose 16 characters as the “extra” length for a `StringBuilder` object because 16 characters fully occupy four bytes of memory. As you work more with computers in general and programming in particular, you will notice that storage capacities are almost always created in exponential values of 2—for example, 4, 8, 16, 32, 64, and so on.

In the application in Figure 7-12, the `addressString` variable is created as `StringBuilder addressString = null;`. The variable does not refer to anything until it is initialized with the defined `StringBuilder` object in the following statement:

```
addressString = new StringBuilder("6311 Hickory Nut Grove Road");
```

The capacity of this new `StringBuilder` object is shown in Figure 7-13 as the length of the string plus 16, or 43.

In the application shown in Figure 7-12, the length of each of the `Strings` is changed to 20 using the `setLength()` method. The application displays the expanded `nameString` and “end”, so you can see in the output that there are 13 extra spaces at the end of the `String`. The application also displays the truncated `addressString` so that you can see the effect of reducing its length to 20.

Using `StringBuilder` objects provides improved computer performance over `String` objects because you can insert or append new contents into a `StringBuilder`. In other words, unlike immutable `Strings`, the ability of `StringBuilders` to be modified makes them more efficient when you know string contents will change.



Although the `equals()` method compares `String` object contents, when you use it with `StringBuilder` objects, it compares references. You can compare the contents of two `StringBuilder` objects by converting them to `Strings` with an expression such as the following: `obj1.toString().equals(obj2.toString())`

The `StringBuilder` class provides you with four constructors as follows:

- `public StringBuilder()` constructs a `StringBuilder` with no characters and a default size of 16 characters.
- `public StringBuilder(int capacity)` constructs a `StringBuilder` with no characters and a capacity specified by the parameter.
- `public StringBuilder(String s)` contains the same characters as those stored in the `String` object `s`. (The capacity of the `StringBuilder` is the length of the `String` argument you provide, plus 16 additional characters.)
- The fourth `StringBuilder` constructor uses an argument of type `CharSequence`. `CharSequence` is another Java class; it is an interface that holds a sequence of `char` values. You will learn to create interfaces in the chapter *Advanced Inheritance Concepts*.

The **`append()` method** lets you add characters to the end of a `StringBuilder` object. For example, the following two statements together declare `phrase` to hold “Happy” and alter the phrase to hold “Happy birthday”:

```
StringBuilder phrase = new StringBuilder("Happy");  
phrase.append(" birthday");
```

The **`insert()` method** lets you add characters at a specific location within a `StringBuilder` object. For example, if `phrase` refers to “Happy birthday”, then `phrase.insert(6, "30th ");` alters the `StringBuilder` to contain “Happy 30th birthday”. The first character in the `StringBuilder` object occupies position zero.

To alter just one character in a `StringBuilder`, you can use the **`setCharAt()` method**, which allows you to change a character at a specified position within a `StringBuilder` object. This method requires two arguments: an integer position and a character. If `phrase` refers to “Happy 30th birthday”, then `phrase.setCharAt(6, '4');` changes the value into a 40th birthday greeting.

One way you can extract a character from a `StringBuilder` object is to use the `charAt()` method. The **`charAt()` method** accepts an argument that is the offset of the character position from the beginning of a `String` and returns the character at that position. The following statements assign the character ‘P’ to the variable `letter`:

```
StringBuilder text = new StringBuilder("Java Programming");  
char letter = text.charAt(5);
```

If you try to use an index that is less than 0 or greater than the index of the last position in the `StringBuilder` object, you cause an error known as an exception and your program terminates.

When you can approximate the eventual size needed for a `StringBuilder` object, assigning sufficient capacity can improve program performance. For example, the program in Figure 7-14 compares the time needed to append “Java” 20,000 times to two `StringBuilder` objects—one

that has the initial default size of 16 characters and another that has an initial size of 80,000 characters. Figure 7-15 shows the execution. The extra time needed for the loop that uses the shorter `StringBuilder` is the result of repeatedly assigning new memory as the object grows in size.

```
public class CompareConcatenationTimes
{
    public static void main(String[] args)
    {
        long startTime1, startTime2,
            endTime1, endTime2;
        final int TIMES = 20000;
        int x;
        StringBuilder string1 = new StringBuilder("");
        StringBuilder string2 = new StringBuilder(TIMES * 4);
        startTime1 = System.currentTimeMillis();
        for(x = 0; x < TIMES; ++x)
            string1.append("Java");
        endTime1 = System.currentTimeMillis();
        System.out.println("Time for empty StringBuilder : "
            + (endTime1 - startTime1) + " milliseconds");
        startTime2 = System.currentTimeMillis();
        for(x = 0; x < TIMES; ++x)
            string2.append("Java");
        endTime2 = System.currentTimeMillis();
        System.out.println("Time for large StringBuilder : "
            + (endTime2 - startTime2) + " milliseconds");
    }
}
```

Figure 7-14 The `CompareConcatenationTimes` application



```
C:\Java>java CompareConcatenationTimes
Time for empty StringBuilder : 6 milliseconds
Time for large StringBuilder : 2 milliseconds
C:\Java>
```

Figure 7-15 Output of the `CompareConcatenationTimes` program



You saw a demonstration of the `currentTimeMillis()` method in Chapter 6.



Watch the video *StringBuilder*.



Many additional `String` and `StringBuilder` methods exist. Visit the Java Web site at <http://java.sun.com>. Select API Specifications and the version of Java you are using, then select any class from the list to learn about its methods.

## TWO TRUTHS & A LIE

### Learning About the `StringBuilder` and `StringBuffer` Classes

1. When you create a `String`, you have the option of omitting the keyword `new`, but when you initialize a `StringBuilder` object, you must use the keyword `new`, the constructor name, and an initializing value between the constructor's parentheses.
2. When you create a `StringBuilder` object with an initial value of "Juan", its capacity is 16.
3. If a `StringBuilder` named `myAddress` contains "817", then `myAddress.append(" Maple Lane")`; alters `myAddress` to contain "817 Maple Lane".

The false statement is #2. When you create a `StringBuilder` object with an initial value of "Juan", its capacity is the length of the `String` contained in `StringBuilder`, 4, plus 16 more, for a total of 20.

## You Do It

### Using `String` Class Methods

To demonstrate the use of the `String` methods, you will create an application that asks a user for a name and then "fixes" the name so that the first letter of each new word is uppercase, whether the user entered the name that way or not.

### To create the name-repairing application:

1. Open a new text file in your text editor. Enter the following first few lines of a `RepairName` program. The program declares several variables, including two strings that will refer to a name: one will be “repaired” with correct capitalization; the other will be saved as the user entered it so it can be displayed in its original form at the end of the program. After declaring the variables, prompt the user for a name:

```
import javax.swing.*;
public class RepairName
{
    public static void main(String[] args)
    {
        String name, saveOriginalName;
        int stringLength;
        int i;
        char c;
        name = JOptionPane.showInputDialog(null,
            "Please enter your first and last name");
```

2. Store the name entered in the `saveOriginalName` variable. Next, calculate the length of the name the user entered, then begin a loop that will examine every character in the name. The first character of a name is always capitalized, so when the loop control variable `i` is 0, the character in that position in the name string is extracted and converted to its uppercase equivalent. Then the name is replaced with the uppercase character appended to the remainder of the existing name.

```
saveOriginalName = name;
stringLength = name.length();
for(i=0; i < stringLength; i++)
{
    c = name.charAt(i);
    if(i == 0)
    {
        c = Character.toUpperCase(c);
        name = c + name.substring(1, stringLength);
    }
```

3. After the first character in the name is converted, the program looks through the rest of the name, testing for spaces and capitalizing every character that follows a space. When a space is found at position `i`, `i` is increased, the next character is extracted from the name, the character is converted to its uppercase version, and a new name string is created using the old string up to the current position, the newly capitalized letter, and the remainder of the name string. The `if...else` ends and the `for` loop ends.

```
else
    if(name.charAt(i) == ' ')
    {
        ++i;
        c = name.charAt(i);
        c = Character.toUpperCase(c);
        name = name.substring(0, i) + c +
            name.substring(i + 1, stringLength);
    }
}
```

- After every character has been examined, display the original and repaired names, and add closing braces for the `main()` method and the class.

```

        JOptionPane.showMessageDialog(null, "Original name was " +
            saveOriginalName + "\nRepaired name is " + name);
    }
}

```

- Save the application as **RepairName.java**, and then compile and run the program. Figure 7-16 shows a typical program execution. Make certain you understand how all the `String` methods contribute to the success of this program.



**Figure 7-16** Typical execution of the RepairName application

## Converting a String to an Integer

In the next steps, you will prompt the user for a number, read characters from the keyboard, store the characters in a `String`, and then convert the `String` to an integer that can be used in arithmetic statements.

### To create a program that accepts integer input:

- Open a new text file in your text editor. Type the first few lines of a `NumberInput` class that will accept string input:

```

import javax.swing.*;
public class NumberInput
{
    public static void main(String[] args)
    {

```

- Declare the following variables for the input `String`, the integer to which it is converted, and the result:

```

String inputString;
int inputNumber;
int result;

```



3. Declare a constant that holds a multiplier factor. This program will multiply the user's input by 10:

```
final int FACTOR = 10;
```

4. Enter the following input dialog box statement that stores the user keyboard input in the String variable `inputString`:

```
inputString = JOptionPane.showInputDialog(null,  
    "Enter a number");
```

5. Use the following `Integer.parseInt()` method to convert the input String to an integer. Then multiply the integer by 10 and display the result:

```
inputNumber = Integer.parseInt(inputString);  
result = inputNumber * FACTOR;  
JOptionPane.showMessageDialog(null,  
    inputNumber + " * " + FACTOR + " = " + result);
```

6. Add the final two closing curly braces for the program, then save the program as **NumberInput.java** and compile and test the program. Figure 7-17 shows a typical execution. Even though the user enters a String, it can be used successfully in an arithmetic statement because it was converted using the `parseInt()` method.



**Figure 7-17** Typical execution of the `NumberInput` program

## Using `StringBuilder` Methods

### To use `StringBuilder` methods:

1. Open a new text file and type the following first lines of a `DemoStringBuilder` class:

```
public class DemoStringBuilder  
{  
    public static void main(String[] args)  
    {
```

2. Use the following code to create a `StringBuilder` variable, and then call a `print()` method (that you will create in Step 7) to display the `StringBuilder`:

```
StringBuilder str = new StringBuilder("singing");  
print(str);
```

3. Enter the following `append()` method to add characters to the existing `StringBuilder` and display it again:

```
str.append(" in the dead of ");  
print(str);
```

4. Enter the following `insert()` method to insert characters. Then display the `StringBuilder`, insert additional characters, and display it again:

```
str.insert(0, "Black");  
print(str);  
str.insert(5, "bird ");  
print(str);
```

5. Add one more `append()` and `print()` combination:

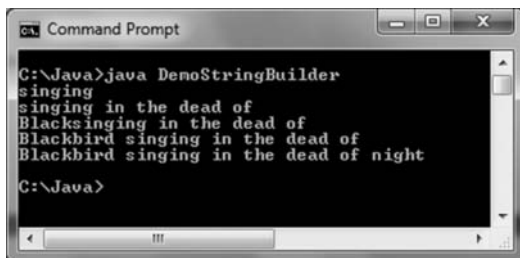
```
str.append("night");  
print(str);
```

6. Add a closing curly brace for the `main()` method.

7. Enter the following `print()` method that displays `StringBuilder` objects:

```
public static void print(StringBuilder s)  
{  
    System.out.println(s);  
}
```

8. Type the closing curly brace for the class, and then save the file as **DemoStringBuilder.java**. Compile and execute, and then compare your output to Figure 7-18.



```
C:\Java>java DemoStringBuilder  
singing  
singing in the dead of  
Black singing in the dead of  
Blackbird singing in the dead of night  
C:\Java>
```

**Figure 7-18** Output of the `DemoStringBuilder` application

## Don't Do It

- Don't attempt to compare `Strings` using the standard comparison operators. The `==` operator will only compare the addresses of `Strings`, and the `<` and `>` operators will not work.
- Don't forget to use the `new` operator and the constructor when declaring initialized `StringBuilder` objects.

## Key Terms

A **reference** is a variable that holds a memory address.

The **Character class** is one whose instances can hold a single character value. This class also defines methods that can manipulate or inspect single-character data.

The **String class** is for working with fixed-string data—that is, unchanging data composed of multiple characters.

The **StringBuilder** and **StringBuffer classes** are for storing and manipulating changeable data composed of multiple characters. It is an alternative to the `String` class when you know a `String` will be modified.

An **anonymous object** is an unnamed object.

A **String variable** is a named object of the `String` class.

**Immutable** objects cannot be changed.

The `String` class **`equals()` method** evaluates the contents of two `String` objects to determine if they are equivalent.

A **lexicographical comparison** is based on the integer Unicode values of characters.

The `String` class **`equalsIgnoreCase()` method** is similar to the `equals()` method. As its name implies, it ignores case when determining if two `Strings` are equivalent.

The `String` class **`compareTo()` method** is used to compare two `Strings`; the method returns zero only if the two `Strings` refer to the same value. If there is any difference between the `Strings`, a negative number is returned if the calling object is “less than” the argument, and a positive number is returned if the calling object is “more than” the argument.

The `String` class **`toUpperCase()` method** converts any `String` to its uppercase equivalent.

The `String` class **`toLowerCase()` method** converts any `String` to its lowercase equivalent.

The `String` class **`length()` method** returns the length of a `String`.

**Accessor methods** return information about an object.

The `String` class **`indexOf()` method** determines whether a specific character occurs within a `String`. If it does, the method returns the position of the character; the first position of a `String` begins with zero. The return value is `-1` if the character does not exist in the `String`.

The `String` class **`charAt()` method** requires an integer argument that indicates the position of the character that the method returns.

The `String` class **`endsWith()` method** takes a `String` argument and returns `true` or `false` if a `String` object does or does not end with the specified argument.

The `String` class **`startsWith()` method** takes a `String` argument and returns `true` or `false` if a `String` object does or does not start with the specified argument.

The `String` class **`replace()` method** allows you to replace all occurrences of some character within a `String`.

The **`toString()` method** converts any object to a `String`.

**Concatenation** is the process of joining a variable to a string to create a longer string.

The **`substring()` method** allows you to extract part of a `String`.

The **Integer class** is a wrapper class that contains a simple integer and useful methods to manipulate it.

A **wrapper** is a class or object that is “wrapped around” a simpler element.

The `Integer` class **`parseInt()` method** takes a `String` argument and returns its integer value.

The **Double class** is a wrapper class that contains a simple double and useful methods to manipulate it.

The `Double` class **`parseDouble()` method** takes a `String` argument and returns its double value.

A **buffer** is a block of memory.

The **capacity** of a `StringBuilder` object is the actual length of the buffer, as opposed to that of the string contained in the buffer.

The `StringBuilder` class **`setLength()` method** changes the length of the characters in the `String` in a `StringBuilder` object.

The **length property** is an attribute of the `StringBuilder` class that identifies the number of characters in the `String` contained in the `StringBuilder`.

The `StringBuilder` class **`capacity()` method** returns the actual length, or capacity, of the `StringBuilder` object.

The `StringBuilder` class **`append()` method** lets you add characters to the end of a `StringBuilder` object.

The `StringBuilder` class **`insert()` method** lets you add characters at a specific location within a `StringBuilder` object.

The `StringBuilder` class **`setCharAt()` method** allows you to change a character at a specified position within a `StringBuilder` object.

The `StringBuilder` class **`charAt()` method** accepts an argument that is the offset of the character position from the beginning of a `String` and returns the character at that position.

## Chapter Summary

- String variables are references, so they require special techniques for making comparisons.
- The `Character` class is one whose instances can hold a single character value. This class also defines methods that can manipulate or inspect single-character data.
- A sequence of characters enclosed within double quotation marks is a literal string. You can create a `String` object by using the keyword `new` and the `String` constructor. Unlike other classes, you also can create a `String` object without using the keyword `new` or explicitly calling the class constructor. Strings are immutable. Useful `String` class methods include `equals()`, `equalsIgnoreCase()`, and `compareTo()`.
- Additional useful `String` methods include `toUpperCase()`, `toLowerCase()`, `length()`, `indexOf()`, `charAt()`, `endsWith()`, `startsWith()`, and `replace()`. The `toString()` method converts any object to a `String`. You can join strings with other strings or values by using a plus sign (`+`); this process is called concatenation. You can extract part of a `String` with the `substring()` method.
- If a `String` contains appropriate characters, you can convert it to a number with the help of the following methods: `Integer.parseInt()`, `Integer.valueOf()`, `intValue()`, `Double.parseDouble()`, `Double.valueOf()`, and `doubleValue()`.
- You can use the `StringBuilder` or `StringBuffer` class to improve performance when a string's contents must change.

## Review Questions

1. A sequence of characters enclosed within double quotation marks is a \_\_\_\_\_.
  - a. symbolic string
  - b. literal string
  - c. prompt
  - d. command
2. To create a `String` object, you can use the keyword \_\_\_\_\_ before the constructor call, but you are not required to use this format.
  - a. object
  - b. create
  - c. char
  - d. new

3. A `String` variable name is a \_\_\_\_\_.
- a. reference
  - b. value
  - c. constant
  - d. literal
4. The term that programmers use to describe objects that cannot be changed is \_\_\_\_\_.
- a. irrevocable
  - b. nonvolatile
  - c. immutable
  - d. stable
5. Suppose you declare two `String` objects as:
- ```
String word1 = new String("happy");
String word2;
```
- When you ask a user to enter a value for `word2`, if the user types "happy", the value of `word1 == word2` is \_\_\_\_\_.
- a. true
  - b. false
  - c. illegal
  - d. unknown
6. If you declare two `String` objects as:
- ```
String word1 = new String("happy");
String word2 = new String("happy");
```
- the value of `word1.equals(word2)` is \_\_\_\_\_.
- a. true
  - b. false
  - c. illegal
  - d. unknown
7. The method that determines whether two `String` objects are equivalent, regardless of case, is \_\_\_\_\_.
- a. `equalsNoCase()`
  - b. `toUpperCase()`
  - c. `equalsIgnoreCase()`
  - d. `equals()`
8. If a `String` is declared as:
- ```
String aStr = new String("lima bean");
```
- then `aStr.equals("Lima Bean")` is \_\_\_\_\_.
- a. true
  - b. false
  - c. illegal
  - d. unknown
9. If you create two `String` objects:
- ```
String name1 = new String("Jordan");
String name2 = new String("Jore");
```
- then `name1.compareTo(name2)` has a value of \_\_\_\_\_.
- a. true
  - b. false
  - c. -1
  - d. 1

10. If `String myFriend = new String("Ginny");`, which of the following has the value 1?
- a. `myFriend.compareTo("Gabby");`
  - b. `myFriend.compareTo("Gabriella");`
  - c. `myFriend.compareTo("Ghazala");`
  - d. `myFriend.compareTo("Hammie");`
11. If `String movie = new String("West Side Story");`, the value of `movie.indexOf('s')` is \_\_\_\_\_.
- a. true
  - b. false
  - c. 2
  - d. 3
12. The `String` class `replace()` method replaces \_\_\_\_\_.
- a. a `String` with a character
  - b. one `String` with another `String`
  - c. one character in a `String` with another character
  - d. every occurrence of a character in a `String` with another character
13. The `toString()` method converts a(n) \_\_\_\_\_ to a `String`.
- a. `char`
  - b. `int`
  - c. `float`
  - d. all of the above
14. Joining `Strings` with a `+` is called \_\_\_\_\_.
- a. chaining
  - b. concatenation
  - c. parsing
  - d. linking
15. The first position in a `String` \_\_\_\_\_.
- a. must be alphabetic
  - b. must be uppercase
  - c. is position zero
  - d. is ignored by the `compareTo()` method
16. The method that extracts a string from within another string is \_\_\_\_\_.
- a. `extract()`
  - b. `parseString()`
  - c. `substring()`
  - d. `append()`
17. The method `parseInt()` converts a(n) \_\_\_\_\_.
- a. integer to a `String`
  - b. integer to a `Double`
  - c. `Double` to a `String`
  - d. `String` to an integer

18. The difference between `int` and `Integer` is \_\_\_\_\_.
- `int` is a primitive type; `Integer` is a class
  - `int` is a class; `Integer` is a primitive type
  - nonexistent; both are primitive types
  - nonexistent; both are classes
19. For an alternative to the `String` class, and so you can change a `String`'s contents, you can use \_\_\_\_\_.
- `char`
  - `StringHolder`
  - `StringBuilder`
  - `StringMerger`
20. Unlike when you create a `String`, when you create a `StringBuilder`, you must use the keyword \_\_\_\_\_.
- `buffer`
  - `new`
  - `null`
  - `class`

## Exercises

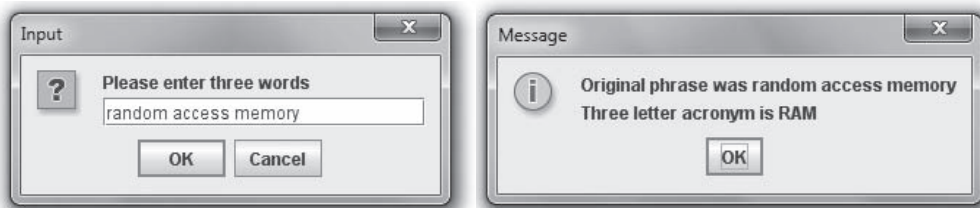
- Write an application that concatenates three `Strings` that hold one of your favorite quotations, the name of the person who said it, and the dates that person lived. Display each `String` and the concatenated `String`. Save the file as **JoinStrings.java**.
- Write an application that counts the total number of vowels contained in the `String` "Home is the place, when you have to go there, they have to take you in. – Robert Frost". Save the file as **CountVowels.java**.
  - Write an application that counts the total number of vowels contained in a `String` entered by the user. Save the file as **CountVowels2.java**.
- Write an application that counts the total number of letters contained in a quotation of your choice. Save the file as **CountLetters.java**.
  - Write an application that counts the total number of letters contained in a `String` entered by the user. Save the file as **CountLetters2.java**.
- Write an application that counts the total number of whitespaces contained in a stored `String`. Save the file as **CountWhitespaces.java**.
  - Write an application that counts the total number of whitespaces contained in a `String` entered by the user. Save the file as **CountWhitespaces2.java**.
- Write an application that demonstrates that when two identical names are compared and the case differs, the `equals()` method returns `false`, but the `equalsIgnoreCase()` method returns `true`. Save the file as **ComparisonCase.java**.
- Write an application that demonstrates conditions under which the `compareTo()` method returns a positive number, a negative number, and a zero when used to compare two `Strings`. Save the file as **CompareStringValues.java**.



7. Write an application that demonstrates each of the following methods based on the following quote: “It is better to deserve honours and not have them than to have them and not deserve them.” – Mark Twain.
  - ♦ `indexOf('h')`
  - ♦ `charAt(14)`
  - ♦ `endsWith("Twain")`
  - ♦ `replace('a', 'A')`

Save the file as **DemonstrateStringMethods.java**.

8. Three-letter acronyms are common in the business world. For example, in Java you use the IDE (Integrated Development Environment) in the JDK (Java Development Kit) to write programs used by the JVM (Java Virtual Machine) that you might send over a LAN (Local Area Network). Programmers even use the acronym TLA to stand for *three-letter acronym*. Write a program that allows a user to enter three words, and display the appropriate three-letter acronym in all uppercase letters. If the user enters more than three words, ignore the extra words. Figure 7-19 shows a typical execution. Save the file as **ThreeLetterAcronym.java**.



**Figure 7-19** Typical execution of the `ThreeLetterAcronym` program

9. Create a class that holds three initialized `StringBuilder` objects: your first name, middle name, and last name. Create three new `StringBuilder` objects as follows:
  - ♦ An object named `entireName` that refers to your three names, separated by spaces
  - ♦ An object named `lastFirst` that refers to your last name, a comma, a space, and your first name, in that order
  - ♦ An object named `signature` that refers to your first name, a space, your middle initial (not the entire name), a period, a space, and your last nameDisplay all three objects. Save the file as **Builder.java**.
10. Write an application that determines whether a phrase entered by the user is a palindrome. A palindrome is a phrase that reads the same backward and forward without regarding capitalization or punctuation. For example, “Dot saw I was Tod”,

“Was it a car or a cat I saw?”, and “Madam, I’m Adam” are palindromes. Save the file as **Palindrome.java**.

11. Write an application that prompts a user for a full name and street address and constructs an ID from the user’s initials and numeric part of the address. For example, the user William Henry Harrison who lives at 34 Elm would have an ID of WHH34, whereas user Addison Mitchell who lives at 1778 Monroe would have an ID of AM1778. Save the file as **ConstructID.java**.
12. Write an application that accepts a user’s password from the keyboard. When the entered password is less than six characters, more than 10 characters, or does not contain at least one letter and one digit, prompt the user again. When the user’s entry meets all the password requirements, prompt the user to reenter the password, and do not let the user continue until the second password matches the first one. Save the file as **Password.java**.
13. Create a `TaxReturn` class with fields that hold a taxpayer’s Social Security number, last name, first name, street address, city, state, zip code, annual income, marital status, and tax liability. Include a constructor that requires arguments that provide values for all the fields other than the tax liability. The constructor calculates the tax liability based on annual income and the percentages in the following table.

| Income (\$)     | Marital status |         |
|-----------------|----------------|---------|
|                 | Single         | Married |
| 0–20,000        | 15%            | 14%     |
| 20,001–50,000   | 22%            | 20%     |
| 50,001 and over | 30%            | 28%     |

In the `TaxReturn` class, also include a display method that displays all the `TaxReturn` data. Save the file as **TaxReturn.java**.

Create an application that prompts a user for the data needed to create a `TaxReturn`. Continue to prompt the user for data as long as any of the following are true:

- The Social Security number is not in the correct format, with digits and dashes in the appropriate positions; for example, 999-99-9999.
- The zip code is not five digits.
- The marital status does not begin with one of the following: “S”, “s”, “M”, or “m”.
- The annual income is negative.

After all the input data is correct, create a `TaxReturn` object and then display its values. Save the file as **PrepareTax.java**.



## Debugging Exercise

14. Each of the following files in the Chapter.07 folder of your downloadable student files has syntax and/or logic errors. In each case, determine the problem and fix the program. After you correct the errors, save each file using the same filename preceded with Fix. For example, DebugSeven1.java will become FixDebugSeven1.java.
- DebugSeven1.java
  - DebugSeven2.java
  - DebugSeven3.java
  - DebugSeven4.java

337

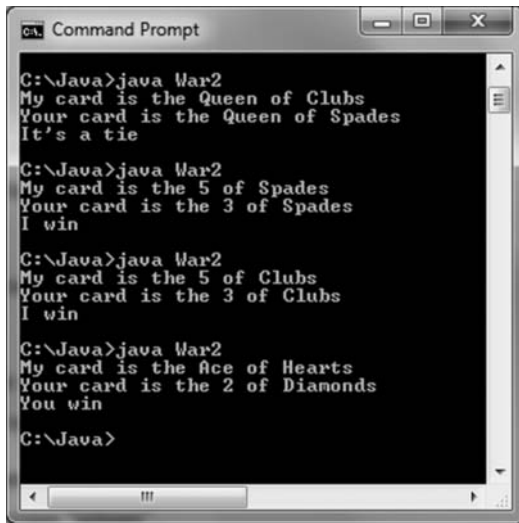


## Game Zone

15. a. In Chapter 3, you designed a Card class. The class holds fields that contain a Card's value and suit. Currently, the suit is represented by a single character (s, h, d, or c). Modify the class so that the suit is a string ("Spades", "Hearts", "Diamonds", or "Clubs"). Also, add a new field to the class to hold the string representation of a Card's rank based on its value. Within the Card class `setValue()` method, besides setting the numeric value, also set the string rank value as follows.

| Numeric value | String value for rank |
|---------------|-----------------------|
| 1             | "Ace"                 |
| 2 through 10  | "2" through "10"      |
| 11            | "Jack"                |
| 12            | "Queen"               |
| 13            | "King"                |

- b. In Chapter 5, you created a War Card game that randomly selects two cards (one for the player and one for the computer) and declares a winner (or a tie). Modify the game to set each Card's suit as the appropriate string, then execute the game using the newly modified Card class. Figure 7-20 shows four typical executions. Recall that in this version of War, you assume that the ace is the lowest-valued card. Save the game as **War2.java**.



```
C:\Java>java War2
My card is the Queen of Clubs
Your card is the Queen of Spades
It's a tie

C:\Java>java War2
My card is the 5 of Spades
Your card is the 3 of Spades
I win

C:\Java>java War2
My card is the 5 of Clubs
Your card is the 3 of Clubs
I win

C:\Java>java War2
My card is the Ace of Hearts
Your card is the 2 of Dianonds
You win

C:\Java>
```

**Figure 7-20** Four typical executions of the War2 game

16. In Chapter 5, you created a Rock Paper Scissors game. In the game, a player entered a number to represent one of the three choices. Make the following improvements to the game:
  - Allow the user to enter a string (“rock”, “paper”, or “scissors”) instead of a digit.
  - Make sure the game works correctly whether the player enters a choice in uppercase or lowercase letters or a combination of the two.
  - To allow for player misspellings, accept the player’s entry as long as the first two letters are correct. (In other words, if a player types “scixxrs”, you will accept it as “scissors” because at least the first two letters are correct.)
  - When the player does not type at least the first two letters of the choice correctly, reprompt the player and continue to do so until the player’s entry contains at least the first two letters of one of the options.
  - Allow 10 complete rounds of the game. At the end, display counts of the number of times the player won, the number of times the computer won, and the number of tie games.

Save the file as **RockPaperScissors2.java**.

17. Create a simple guessing game, similar to Hangman, in which the user guesses letters and then attempts to guess a partially hidden phrase. Display a phrase in which some of the letters are replaced by asterisks; for example, “G\* T\*\*\*” (for “Go Team”). Each time the user guesses a letter, either place the letter in the correct spot (or spots) in the phrase and display it again, or tell the user the guessed letter is not in the phrase. Display a congratulatory message when the entire correct phrase has been deduced. Save the game as **SecretPhrase.java**. In the next chapter, you will

modify this program so that instead of presenting the user with the same phrase every time the game is played, the program will randomly select the phrase from a list of phrases.

18. Eliza is a famous 1966 computer program written by Joseph Weizenbaum. It imitates a psychologist (more specifically, a Rogerian therapist) by rephrasing many of a patient's statements as questions and posing them to the patient. This type of therapy (sometimes called nondirectional) is often parodied in movies and television shows, in which the therapist does not even have to listen to the patient, but gives "canned" responses that lead the patient from statement to statement. For example, when the patient says, "I am having trouble with my brother," the therapist might say, "Tell me more about your brother." If the patient says, "I dislike school," the therapist might say, "Why do you say you dislike school?" Eliza became a milestone in the history of computers because it was the first time a computer programmer attempted to create the illusion of human-to-human interaction.

Create a simple version of Eliza by allowing the user to enter statements continually until the user quits by typing "Goodbye". After each statement, have the computer make one of the following responses:

- If the user entered the word "my" (for example, "I am having trouble with my brother"), respond with "Tell me more about your" and insert the noun in question—for example, "Tell me more about your brother". When you search for a word in the user's entry, make sure it is the entire word and not just letters within another word. For example, when searching for *my*, make sure it is not part of another word such as *dummy* or *mystic*.
- If the user entered a strong word, such as "love" or "hate", respond with, "You seem to have strong feelings about that".
- Add a few other appropriate responses of your choosing.
- In the absence of any of the preceding inputs, respond with a random phrase from the following: "Please go on", "Tell me more", or "Continue".

Save the file as **Eliza.java**.

*This page intentionally left blank*

# Arrays

In this chapter, you will:

- ⦿ Declare and initialize an array
- ⦿ Use subscripts with an array
- ⦿ Declare and use arrays of objects
- ⦿ Search an array
- ⦿ Pass arrays to and return arrays from methods

## Declaring and Initializing an Array

While completing the first five chapters in this book, you stored values in variables. In those early chapters, you simply stored a value and used it, usually only once, but never more than a few times. In Chapter 6, you created loops that allow you to “recycle” variables and use them many times; that is, after creating a variable, you can assign a value, use the value, and then, in successive cycles through the loop, reuse the variable as it holds different values.

At times, however, you might encounter situations in which storing just one value at a time in memory does not meet your needs. For example, a sales manager who supervises 20 employees might want to determine whether each employee has produced sales above or below the average amount. When you enter the first employee’s sales value into an application, you can’t determine whether it is above or below average because you don’t know the average until you have all 20 values. Unfortunately, if you attempt to assign 20 sales values to the same variable, when you assign the value for the second employee, it replaces the value for the first employee.

A possible solution is to create 20 separate employee sales variables, each with a unique name, so you can store all the sales until you can determine an average. A drawback to this method is that if you have 20 different variable names to be assigned values, you need 20 separate assignment statements. For 20 different variable names, the statement that calculates total sales will be unwieldy, such as:

```
total = firstAmt + secondAmt + thirdAmt + ...
```

This method might work for 20 salespeople, but what if you have 10,000 salespeople?

The best solution is to create an array. An **array** is a named list of data items that all have the same type. You declare an array variable in the same way you declare any simple variable, but you insert a pair of square brackets after the type. For example, to declare an array of `double` values to hold sales figures for salespeople, you can write the following:

```
double[] salesFigure;
```

Similarly, to create an array of integers to hold student ID numbers, you can write the following:

```
int[] idNum;
```



In Java, you can also declare an array variable by placing the square brackets after the array name, as in `double salesFigure[]`; . This format is familiar to C and C++ programmers, but the preferred format among Java programmers is to place the brackets following the variable type and before the variable name.

After you create an array variable, you still need to reserve memory space. You use the same procedure to create an array that you use to create an object. Recall that when you create a class named `Employee`, you can declare an `Employee` object with a declaration such as:

```
Employee oneWorker;
```

However, that declaration does not actually create the `oneWorker` object. You create the `oneWorker` object when you use the keyword `new` and the constructor method, as in:

```
oneWorker = new Employee();
```



Similarly, declaring an array and reserving memory space for it are two distinct processes. To reserve memory locations for 20 `sale` objects, you declare the array variable with the following statement:

```
double[] sale;
```

Then you create the array with the following statement:

```
sale = new double[20];
```

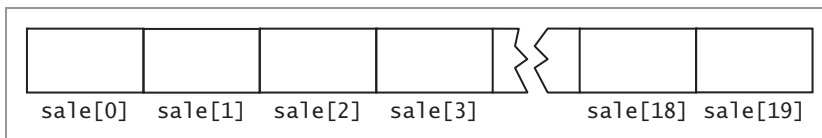
Just as with objects, you can declare and create an array in one statement with the following:

```
double[] sale = new double[20];
```



In Java, the size of an array is never declared immediately following the array name, as it is in some other languages such as C++. Other languages, such as Visual Basic, BASIC, and COBOL, use parentheses rather than brackets to refer to individual array elements. By using brackets, the creators of Java made it easier for you to distinguish array names from methods.

The statement `double[] sale = new double[20];` reserves 20 memory locations for 20 `sale` values. You can distinguish each `sale` from the others with a subscript. A **subscript** is an integer contained within square brackets that indicates one of an array's variables, or **elements**. In Java, any array's elements are numbered beginning with zero, so you can legally use any subscript from 0 through 19 when working with an array that has 20 elements. In other words, the first `sale` array element is `sale[0]` and the last `sale` element is `sale[19]`. Figure 8-1 shows how the array of 20 `sale` values appears in computer memory.



**Figure 8-1** An array of 20 `sale` items in memory

It is common to forget that the first element in an array is element 0, especially if you know another programming language in which the first array element is element 1. Making this mistake means you will be “off by one” in your use of any array. It is also common to forget that the last element's subscript is one less than the array's size and not the array's size. For example, the highest allowed subscript for a 100-element array is 99. To remember that array elements begin with element 0, it might help if you think of the first array element as being “zero elements away from” the beginning of the array, the second element as being “one element away from” the beginning of the array, and so on.

When you work with any individual array element, you treat it no differently than you would treat a single variable of the same type. For example, to assign a value to the first `sale` in an array, you use a simple assignment statement, such as the following:

```
sale[0] = 2100.00;
```

To display the last sale in an array of 20, you can write:

```
System.out.println(sale[19]);
```

When you declare or access an array, you can use any expression to represent the size, as long as the expression is an integer. For example, to declare a `double` array named `money`, you might use any of the following:

344

- A literal integer constant; for example:

```
double[] money = new double[10];
```

- A named integer constant; for example:

```
double[] money = new double[NUMBER_ELS];
```

In this example, the constant `NUMBER_ELS` must have been declared previously and assigned a value.

- An integer variable; for example:

```
double[] money = new double[numberOfEls];
```

In this example, the variable `numberOfEls` must have been declared previously and assigned a value.

- A calculation; for example:

```
double[] money = new double[x + y * z];
```

In this example, the variables `x`, `y`, and `z` must have been declared previously and assigned values.

- A method's return value; for example:

```
double[] money = new double[getElements()];
```

In this example, the method `getElements()` must return an integer.



Some other programming languages, such as C++, allow only named or unnamed constants to be used for array sizes. Java allows variables, which makes array declaration more flexible.

## Initializing an Array

A variable that has a primitive type, such as `int`, holds a value. A variable with a reference type, such as an array, holds a memory address where a value is stored.

Array names represent computer memory addresses; that is, array names contain references, as do all Java objects. When you declare an array name, no computer memory address is assigned to it. Instead, the array variable name has the special value `null`, or Unicode value `'\u0000'`. When you declare `int[] someNums;`, the variable `someNums` has a value of `null`.

When you use the keyword `new` to define an array, the array name acquires an actual memory address value. For example, when you define `someNums` in the following statement, a memory address is assigned:

```
int[] someNums = new int[10];
```

When you declare `int[] someNums = new int[10];`, each element of `someNums` has a value of 0 because `someNums` is a numeric array. (Each element in a `double` or `float` array is assigned 0.0.) By default, `char` array elements are assigned `'\u0000'` and `boolean` array elements automatically are assigned the value `false`.



When you create an array of objects, each reference is assigned the value `null`. Object arrays are discussed later in this chapter.

You already know how to assign a different value to a single element of an array, as in:

```
someNums[0] = 46;
```

You can also assign nondefault values to array elements upon creation. To initialize an array, you use a list of values separated by commas and enclosed within curly braces. For example, if you want to create an array named `tenMult` and store the first six multiples of 10 within the array, you can declare `tenMult` as follows:

```
int[] tenMult = {10, 20, 30, 40, 50, 60};
```

Notice the semicolon at the end of the statement. You don't use a semicolon following a method's closing curly brace, but you do use one following the closing brace of an array initialization list.

Providing values for all the elements in an array is called **populating the array**. When you populate an array upon creation, you do not give the array a size—the size is assigned based on the number of values you place in the initializing list. For example, the `tenMult` array just defined has a size of 6. Also, when you initialize an array, you do not need to use the keyword `new`; instead, new memory is assigned based on the length of the list of provided values.

In Java, you cannot directly initialize part of an array. For example, you cannot create an array of 10 elements and initialize only five; you either must initialize every element or none of them.



Watch the video *Arrays*.

## TWO TRUTHS & A LIE

### Declaring and Initializing an Array

1. The statement `int[] idNum = new int[35];` reserves enough memory for exactly 34 integers.
2. The first element in any array has a subscript of 0 no matter what data type is stored.
3. When you declare `int[] idNum = new int[35];`, each element of the array has a value of 0 because it is a numeric array.

The false statement is #1. The statement `int[] idNum = new int[35];` reserves enough memory for exactly 35 integers numbered 0 through 34.

## Using Subscripts with an Array

If you treat each array element as an individual entity, there isn't much of an advantage to declaring an array over declaring individual **scalar** (primitive) variables, such as `int`, `double`, or `char`. The power of arrays becomes apparent when you begin to use subscripts that are variables, rather than subscripts that are constant values.

For example, suppose you declare an array of five integers that holds quiz scores, such as the following:

```
int[] scoreArray = {2, 14, 35, 67, 85};
```

You might want to perform the same operation on each array element, such as increasing each score by a constant amount. To increase each `scoreArray` element by three points, for example, you can write the following:

```
final int INCREASE = 3;
scoreArray[0] += INCREASE;
scoreArray[1] += INCREASE;
scoreArray[2] += INCREASE;
scoreArray[3] += INCREASE;
scoreArray[4] += INCREASE;
```

With five `scoreArray` elements, this task is manageable, requiring only five statements. However, you can reduce the amount of program code needed by using a variable as the subscript. Then, you can use a loop to perform arithmetic on each array element, as in the following example:

```
final int INCREASE = 3;
for(sub = 0; sub < 5; ++sub)
    scoreArray[sub] += INCREASE;
```

The variable `sub` is set to 0, and then it is compared to 5. Because the value of `sub` is less than 5, the loop executes and 3 is added to `scoreArray[0]`. Then, the variable `sub` is incremented and it becomes 1, which is still less than 5, so when the loop executes again, `scoreArray[1]` is increased by 3, and so on. A process that took five statements now takes only one. In addition, if the array had 100 elements, the first method of increasing the array values by 3 in separate statements would result in 95 additional statements. The only changes required using the second method would be to change the array size to 100 by inserting additional initial values for the scores, and to change the middle portion of the `for` statement to compare `sub` to 100 instead of to 5. The loop to increase 100 separate scores by 3 each is:

```
for(sub = 0; sub < 100; ++sub)
    scoreArray[sub] += INCREASE;
```

When an application contains an array and you want to use every element of the array in some task, it is common to perform loops that vary the loop control variable from 0 to one less than the size of the array. For example, if you get input values for the elements in the array, alter every value in the array, sum all the values in the array, or display every element in the array, you need to perform a loop that executes the same number of times as there are elements. When there are 10 array elements, the subscript varies from 0 through 9; when there are 800 elements, the subscript varies from 0 through 799. Therefore, in an application that includes an array, it is convenient to declare a symbolic constant equal to the size of the array and use the symbolic constant as a limiting value in every loop that processes the array. That way, if the array size changes in the future, you need to modify only the value stored in the symbolic constant, and you do not need to search for and modify the limiting value in every loop that processes the array.

For example, suppose you declare an array and a symbolic constant as follows:

```
int[] scoreArray = {2, 14, 35, 67, 85};
final int NUMBER_OF_SCORES = 5;
```

Then, the following two loops are identical:

```
for(sub = 0; sub < 5; ++sub)
    scoreArray[sub] += INCREASE;
for(sub = 0; sub < NUMBER_OF_SCORES; ++sub)
    scoreArray[sub] += INCREASE;
```

The second format has two advantages. First, by using the symbolic constant, `NUMBER_OF_SCORES`, the reader understands that you are processing every array element for the size of the entire array. If you use the number 5, the reader must look back to the array declaration to confirm that 5 represents the full size of the array. Second, if the array size changes because you remove or add scores, you change the symbolic constant value only once, and all loops that use the constant are automatically altered to perform the correct number of repetitions.

As another option, you can use a field (instance variable) that is automatically assigned a value for every array you create; the **length field** contains the number of elements in the array. For example, when you declare an array using either of the following statements, the field `scoreArray.length` is assigned the value 5:

```
int[] scoreArray = {2, 14, 35, 67, 85};
int[] scoreArray = new int[5];
```

Therefore, you can use the following loop to add 3 to every array element:

```
for(sub = 0; sub < scoreArray.length; ++sub)
    scoreArray[sub] += INCREASE;
```

Later, if you modify the size of the array and recompile the program, the value in the `length` field of the array changes appropriately. When you work with array elements, it is always better to use a symbolic constant or the `length` field when writing a loop that manipulates an array.



A frequent programmer error is to attempt to use `length` as an array method, referring to `scoreArray.length()`. However, `length` is not an array method; it is a field. An instance variable or object field such as `length` is also called a **property** of the object.

In Chapter 6, you learned to use the `for` loop. Java also supports an **enhanced for loop**. This loop allows you to cycle through an array without specifying the starting and ending points for the loop control variable. For example, you can use either of the following statements to display every element in an array named `scoreArray`:

```
for(int sub = 0; sub < scoreArray.length; ++sub)
    System.out.println(scoreArray[sub]);
for(int val : scoreArray)
    System.out.println(val);
```

In the second example, `val` is defined to be the same type as the array named following the colon. Within the loop, `val` takes on, in turn, each value in the array. You can read the second example as, “For each `val` in `scoreArray`, display `val`.” As a matter of fact, you will see the enhanced for loop referred to as a **foreach loop**.

You also can use the enhanced for loop with more complicated Java objects, as you will see in the next section.

## TWO TRUTHS & A LIE

### Using Subscripts with an Array

1. When an application contains an array, it is common to perform loops that vary the loop control variable from 0 to one less than the size of the array.
2. An array's `length` field contains the highest value that can be used as the array's subscript.
3. The enhanced for loop allows you to cycle through an array without specifying the starting and ending points for the loop control variable.

The false statement is #2. An array's `length` field contains the number of elements in the array.

## Declaring and Using Arrays of Objects

Just as you can declare arrays of integers or doubles, you can declare arrays that hold elements of any type, including objects. For example, assume you create the `Employee` class shown in Figure 8-2. This class has two data fields (`empNum` and `empSal`), a constructor, and a get method for each field.

```
public class Employee
{
    private int empNum;
    private double empSal;
    Employee(int e, double s)
    {
        empNum = e;
        empSal = s;
    }
    public int getEmpNum()
    {
        return empNum;
    }
    public double getSalary()
    {
        return empSal;
    }
}
```

**Figure 8-2** The `Employee` class

You can create separate `Employee` objects with unique names, such as either of the following:

```
Employee painter, electrician, plumber;
Employee firstEmployee, secondEmployee, thirdEmployee;
```

However, in many programs it is far more convenient to create an array of `Employee` objects. An array named `emp` that holds seven `Employee` objects can be defined as:

```
Employee[] emp = new Employee[7];
```

This statement reserves enough computer memory for seven `Employee` objects named `emp[0]` through `emp[6]`. However, the statement does not actually construct those `Employee` objects; instead, you must call the seven individual constructors. According to the class definition shown in Figure 8-2, the `Employee` constructor requires two arguments: an employee number and a salary. If you want to number your `Employees` 101, 102, 103, and so on, and start each `Employee` at a salary of \$6.35, the loop that constructs seven `Employee` objects is as follows:

```
final int START_NUM = 101;
final double PAYRATE = 6.35;
for(int x = 0; x < emp.length; ++x)
    emp[x] = new Employee(START_NUM + x, PAYRATE);
```

As `x` varies from 0 through 6, each of the seven `emp` objects is constructed with an employee number that is 101 more than `x`, and each of the seven `emp` objects holds the same salary of \$6.35, as assigned in the constant `PAYRATE`.

Unlike the `Employee` class in Figure 8-2, which contains a constructor that requires arguments, some classes contain only the automatically supplied default constructor and others contain an explicitly written default constructor that requires no arguments. To construct an array of objects using a default constructor, you must still call the constructor using the keyword `new` for each declared array element. For example, suppose you have created a class named `InventoryItem` but have not written a constructor. To create an array of 1,000 `InventoryItem` objects, you would write the following:

```
final int NUM_ITEMS = 1000;
InventoryItem[] items = new InventoryItem[NUM_ITEMS];
for(int x = 0; x < NUM_ITEMS; ++x)
    items[x] = new InventoryItem();
```

To use a method that belongs to an object that is part of an array, you insert the appropriate subscript notation after the array name and before the dot that precedes the method name. For example, to display data for seven `Employee`s stored in the `emp` array, you can write the following:

```
for(int x = 0; x < emp.length; ++x)
    System.out.println (emp[x].getEmpNum() + " " + emp[x].getSalary());
```

Pay attention to the syntax of the `Employee` objects' method calls, such as `emp[x].getEmpNum()`. Although you might be tempted to place the subscript at the end of the expression after the method name—as in `emp.getEmpNum[x]` or `emp.getEmpNum()[x]`—you cannot; the values in `x` (0 through 6) refer to a particular `emp`, each of which has access to a single `getEmpNum()` method. Placement of the bracketed subscript so it follows `emp` means the method “belongs” to a particular `emp`.

## Using the Enhanced for Loop

You can use the enhanced for loop to cycle through an array of objects. For example, to display data for seven `Employee`s stored in the `emp` array, you can write the following:

```
for(Employee worker : emp)
    System.out.println(worker.getEmpNum() + " " + worker.getSalary());
```

In this loop, `worker` is a local variable that represents each element of `emp` in turn. Using the enhanced for loop eliminates the need to use a limiting value for the loop and eliminates the need for a subscript following each element.

## Manipulating Arrays of Strings

As with any other object, you can create an array of `Strings`. For example, you can store three company department names as follows:

```
String[] deptName = {"Accounting", "Human Resources", "Sales"};
```



You can access these department names like any other array object. For example, you can use the following code to display the list of `String`s stored in the `deptName` array:

```
for(int a = 0; a < deptName.length; ++a)
    System.out.println(deptName[a]);
```



Notice that `deptName.length`; refers to the length of the array `deptName` (three elements) and not to the length of any `String` objects stored in the `deptName` array. Arrays use a `length` field (no parentheses follow). Each `String` object has access to a `length()` method that returns the length of a `String`. For example, if `deptName[0]` is "Accounting", then `deptName[0].length()` is 10 because "Accounting" contains 10 characters.

In Chapter 7, you learned about methods for comparing characters and comparing strings. You determined whether strings contained the same value and, if they were different, which one was considered larger. With arrays, you often want to know whether a certain character or string can be found within the elements of the array. For example, does the letter 'z' appear in an array of characters, or does the name "John" appear in an array of first names? The idea is to search the array to see if you can find an exact match. The `SearchList` application in Figure 8-3 shows an example of such a search. The user enters a department name, and the application provides a message indicating whether the `String` was found. Figure 8-4 shows a typical execution.

```
import javax.swing.*;
public class SearchList
{
    public static void main(String[] args)
    {
        String[] deptName = {"Accounting", "Human Resources", "Sales"};
        String dept;
        int x;
        boolean deptWasFound = false;
        dept = JOptionPane.showInputDialog(null,
            "Enter a department name");
        for(x = 0; x < deptName.length; ++x)
            if(dept.equals(deptName[x]))
                deptWasFound = true;
        if(deptWasFound)
            JOptionPane.showMessageDialog(null, dept +
                " was found in the list");
        else
            JOptionPane.showMessageDialog(null, dept +
                " was not found in the list");
    }
}
```

**Figure 8-3** The `SearchList` class

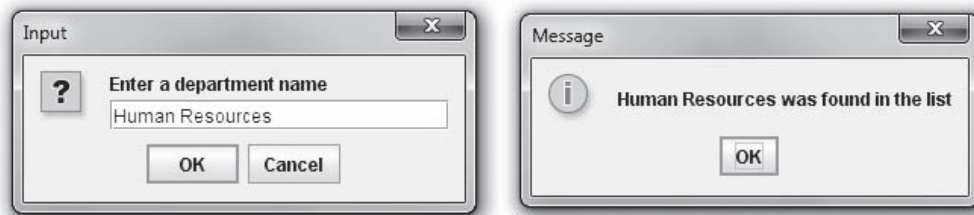


Figure 8-4 Typical execution of the SearchList application

## TWO TRUTHS & A LIE

### Declaring and Using Arrays of Objects

1. The following statement declares an array named `students` that holds 10 `Student` objects:  

```
Student[] students = new Student[10];
```
2. When a class has a default constructor and you create an array of objects from the class, you do not need to call the constructor explicitly.
3. To use a method that belongs to an object that is part of an array, you insert the appropriate subscript notation after the array name and before the dot that precedes the method name.

The false statement is #2. Whether a class has a default constructor or not, when you create an array of objects from the class, you must call the constructor using the keyword `new` for each declared array element.

## Searching an Array

When you want to determine whether a variable holds one of many valid values, one option is to use a series of `if` statements to compare the variable to a series of valid values. Suppose that a company manufactures 10 items. When a customer places an order for an item, you need to determine whether the item number on the order form is valid. If valid item numbers are sequential, such as 101 through 110, the following simple `if` statement that uses a logical AND can verify the order number and set a Boolean field to `true`:

```
final int LOW = 101;
final int HIGH = 110;
boolean validItem = false;
if(itemOrdered >= LOW && itemOrdered <= HIGH)
    validItem = true;
```

If the valid item numbers are nonsequential—for example, 101, 108, 201, 213, 266, 304, and so on—you can code the following deeply nested `if` statement or a lengthy OR comparison to determine the validity of an item number:

```
if(itemOrdered == 101)
    validItem = true;
else if(itemOrdered == 108)
    validItem = true;
else if(itemOrdered == 201)
    validItem = true;
// and so on
```

Instead of a long series of `if` statements, a more elegant solution is to compare the `itemOrdered` variable to a list of values in an array, a process called **searching an array**. You can initialize the array with the valid values using the following statement, which creates exactly 10 array elements with subscripts 0 through 9:

```
int[] validValues = {101, 108, 201, 213, 266,
    304, 311, 409, 411, 412};
```

After the list of valid values is initialized, you can use a `for` statement to loop through the array, and set a Boolean variable to `true` when a match is found:

```
for(int x = 0; x < validValues.length; ++x)
{
    if(itemOrdered == validValues[x])
        validItem = true;
}
```

This simple `for` loop replaces the long series of `if` statements; it checks the `itemOrdered` value against each of the 10 array values in turn. Also, if a company carries 1,000 items instead of 10, nothing changes in the `for` statement—the value of `validValues.length` is updated automatically.

As an added bonus, if you set up another parallel array with the same number of elements and corresponding data, you can use the same subscript to access additional information. A **parallel array** is one with the same number of elements as another, and for which the values in corresponding elements are related. For example, if the 10 items your company carries have 10 different prices, you can set up an array to hold those prices as follows:

```
double[] prices = {0.29, 1.23, 3.50, 0.69...};
```

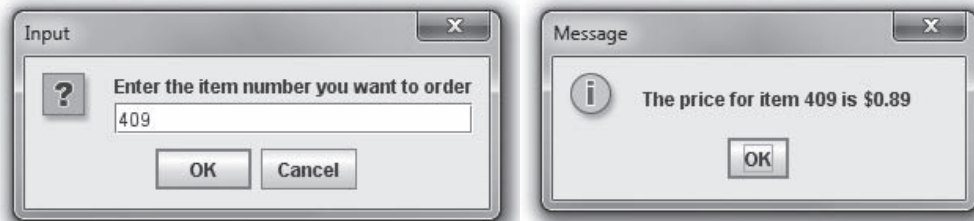
The prices must appear in the same order as their corresponding item numbers in the `validValues` array. Now, the same `for` loop that finds the valid item number also finds the price, as shown in the application in Figure 8-5. In the shaded portion of the code, notice that when the ordered item's number is found in the `validValues` array, the `itemPrice` value is “pulled” from the `prices` array. In other words, if the item number is found in the second

position in the `validValues` array, you can find the correct price in the second position in the `prices` array. Figure 8-6 shows a typical execution of the program. A user requests item 409, which is the eighth element in the `validValues` array, so the price displayed is the eighth element in the `prices` array.

354

```
import javax.swing.*;
public class FindPrice
{
    public static void main(String[] args)
    {
        final int NUMBER_OF_ITEMS = 10;
        int[] validValues = {101, 108, 201, 213, 266,
            304, 311, 409, 411, 412};
        double[] prices = {0.29, 1.23, 3.50, 0.69, 6.79,
            3.19, 0.99, 0.89, 1.26, 8.00};
        String strItem;
        int itemOrdered;
        double itemPrice = 0.0;
        boolean validItem = false;
        strItem = JOptionPane.showInputDialog(null,
            "Enter the item number you want to order");
        itemOrdered = Integer.parseInt(strItem);
        for(int x = 0; x < NUMBER_OF_ITEMS; ++x)
        {
            if(itemOrdered == validValues[x])
            {
                validItem = true;
                itemPrice = prices[x];
            }
        }
        if(validItem)
            JOptionPane.showMessageDialog(null, "The price for item " +
                itemOrdered + " is $" + itemPrice);
        else
            JOptionPane.showMessageDialog(null,
                "Sorry - invalid item entered");
    }
}
```

**Figure 8-5** The `FindPrice` application that accesses information in parallel arrays



**Figure 8-6** Typical execution of the FindPrice application



When you initialize parallel arrays, it is convenient to use spacing so that the values that correspond to each other visually align on the screen or printed page.



Instead of parallel arrays containing item numbers and prices, you might prefer to create a class named `Item` in which each instance contains two fields—`itemOrdered` and `itemPrice`. Then you could create a single array of objects that encapsulate item numbers and prices. There are almost always multiple ways to approach programming problems.

Within the code shown in Figure 8-5, you compare every `itemOrdered` with each of the 10 `validValues`. Even when an `itemOrdered` is equivalent to the first value in the `validValues` array (101), you always make nine additional cycles through the array. On each of these nine additional cycles, the comparison between `itemOrdered` and `validValues[x]` is always `false`. As soon as a match for an `itemOrdered` is found, it is most efficient to break out of the `for` loop early. An easy way to accomplish this is to set `x` to a high value within the block of statements executed when there is a match. Then, after a match, the `for` loop does not execute again because the limiting comparison (`x < NUMBER_OF_ITEMS`) is surpassed. Figure 8-7 shows this loop. In an array with many possible matches, it is most efficient to place the more common items first, so they are matched right away. For example, if item 311 is ordered most often, place 311 first in the `validValues` array, and place its price (\$0.99) first in the `prices` array.

```
for(int x = 0; x < NUMBER_OF_ITEMS; ++x)
{
    if(itemOrdered == validValues[x])
    {
        validItem = true;
        itemPrice = prices[x];
        x = NUMBER_OF_ITEMS;
    }
}
```

**Figure 8-7** A `for` loop with an early exit



In Figure 8-7, instead of the statement that sets `x` to 10 (the value of `NUMBER_OF_ITEMS`) when a match is found, in its place within the `for` loop you could insert a `break` statement. However, many programmers feel that breaking out of a `for` loop early, whether you do it by setting a variable's value or by using a `break` statement, disrupts the loop flow and makes the code harder to understand. If you (or your instructor) agree with this philosophy, consider using a method that employs a `while` loop, as described next.

As an alternative to the `for` loop, you can use a `while` loop to search for a match. Using this approach, you set a subscript to zero, and while the `itemOrdered` is not equal to a value in the array, you increase the subscript and keep looking. You search only while the subscript remains lower than the number of elements in the array. If the subscript increases to 10, you never found a match in the 10-element array. If the loop ends before the subscript reaches 10, you found a match and the correct price can be assigned to the `itemPrice` variable. Figure 8-8 shows a loop that uses this programming approach.

```
x = 0;
while(x < NUMBER_OF_ITEMS && itemOrdered != validValues[x])
    ++x;
if(x != NUMBER_OF_ITEMS)
{
    validItem = true;
    itemPrice = prices[x];
}
```

**Figure 8-8** A while loop with an early exit

## Searching an Array for a Range Match

Searching an array for an exact match is not always practical. Suppose your company gives customer discounts based on the quantity of items ordered. Perhaps no discount is given for any order of fewer than a dozen items, but there are increasing discounts available for orders of increasing quantities, as shown in Table 8-1.

| Total Quantity Ordered | Discount |
|------------------------|----------|
| 1 to 12                | None     |
| 13 to 49               | 10%      |
| 50 to 99               | 14%      |
| 100 to 199             | 18%      |
| 200 or more            | 20%      |

**Table 8-1** Discount table

One awkward programming option is to create a single array to store the discount rates. You could use a variable named `numOfItems` as a subscript to the array, but the array would need hundreds of entries, as in the following example:

```
double[] discount = {0, 0, 0, 0, 0, 0, 0, 0, 0,
    0, 0, 0, 0, 0, 0.10, 0.10, 0.10 ...};
```

Thirteen zeroes are listed in the `discount` array. The first array element has a zero subscript and represents a zero discount for zero items. The next 12 discounts (for items 1 through 12) are also zero. When `numOfItems` is 13, `discount[numOfItems]`, or `discount[13]`, is 0.10. The array would store 37 copies of 0.10 for elements 13 through 49. The `discount` array would need to be ridiculously large to hold an exact value for each possible quantity ordered.

A better option is to create two corresponding arrays and perform a **range match**, in which you compare a value to the endpoints of numerical ranges to find the category in which a value belongs. For example, one array can hold the five discount rates, and the other array can hold five discount range limits. The Total Quantity Ordered column in Table 8-1 shows five ranges. If you use only the first figure in each range, you can create an array that holds five low limits:

```
int[] discountRangeLimit = {1, 13, 50, 100, 200};
```

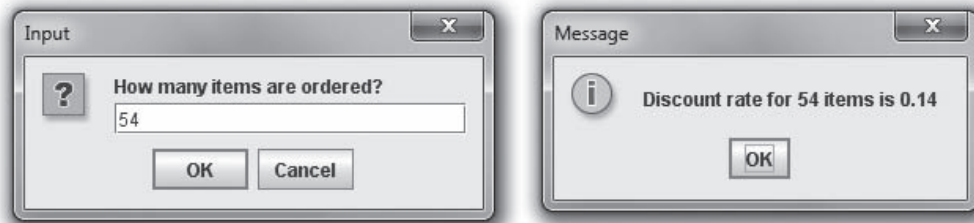
A parallel array can hold the five discount rates:

```
double[] discountRate = {0, 0.10, 0.14, 0.18, 0.20};
```

Then, starting at the last `discountRangeLimit` array element, for any `numOfItems` greater than or equal to `discountRangeLimit[4]`, the appropriate discount is `discount[4]`. In other words, for any `numOrdered` less than `discountRangeLimit[4]`, you should decrement the subscript and look in a lower range. Figure 8-9 shows an application that uses the parallel arrays, and Figure 8-10 shows a typical execution of the program.

```
import javax.swing.*;
public class FindDiscount
{
    public static void main(String[] args)
    {
        final int NUM_RANGES = 5;
        int[] discountRangeLimit = { 1, 13, 50, 100, 200};
        double[] discountRate = {0.00, 0.10, 0.14, 0.18, 0.20};
        double customerDiscount;
        String strNumOrdered;
        int numOrdered;
        int sub = NUM_RANGES - 1;
        strNumOrdered = JOptionPane.showInputDialog(null,
            "How many items are ordered?");
        numOrdered = Integer.parseInt(strNumOrdered);
        while(sub >= 0 && numOrdered < discountRangeLimit[sub])
            --sub;
        customerDiscount = discountRate[sub];
        JOptionPane.showMessageDialog(null, "Discount rate for " +
            numOrdered + " items is " + customerDiscount);
    }
}
```

**Figure 8-9** The `FindDiscount` class



**Figure 8-10** Typical execution of the `FindDiscount` class



In the `while` loop in the application in Figure 8-9, `sub` is required to be greater than or equal to 0 before the second half of the statement that compares `numOrdered` to `discountRangeLimit[sub]` executes. It is a good programming practice to ensure that a subscript to an array does not fall below zero, causing a runtime error.



Watch the video *Searching an Array*.

## TWO TRUTHS & A LIE

### Searching an Array

1. A parallel array is one with the same number of elements as another, and for which the values in corresponding elements are related.
2. When searching an array, it is usually most efficient to abandon the search as soon as the sought-after element is found.
3. In a range match, you commonly compare a value to the midpoint of each of a series of numerical ranges.

The false statement is #3. In a range match, you commonly compare a value to the low or high endpoint of each of a series of numerical ranges, but not to the midpoint.



## Passing Arrays to and Returning Arrays from Methods

You have already seen that you can use any individual array element in the same manner as you use any single variable of the same type. That is, if you declare an integer array as `int[] someNums = new int[12];`, you can subsequently display `someNums[0]`, or increment `someNums[1]`, or work with any element just as you do for any integer. Similarly, you can pass a single array element to a method in exactly the same manner as you pass a variable.

Examine the `PassArrayElement` application shown in Figure 8-11 and the output shown in Figure 8-12. The application creates an array of four integers and displays them. Then, the application calls the `methodGetsOneInt()` method four times, passing each element in turn. The method displays the number, changes the number to 999, and then displays the number again. Finally, back in the `main()` method, the four numbers are displayed again.

```
public class PassArrayElement
{
    public static void main(String[] args)
    {
        final int NUM_ELEMENTS = 4;
        int[] someNums = {5, 10, 15, 20};
        int x;
        System.out.print("At start of main: ");
        for(x = 0; x < NUM_ELEMENTS; ++x)
            System.out.print(" " + someNums[x] );
        System.out.println();
        for(x = 0; x < NUM_ELEMENTS; ++x)
            methodGetsOneInt(someNums[x]);
        System.out.print("At end of main: ");
        for(x = 0; x < NUM_ELEMENTS; ++x)
            System.out.print(" " + someNums[x]);
        System.out.println();
    }
    public static void methodGetsOneInt(int one)
    {
        System.out.print("At start of method one is: " + one);
        one = 999;
        System.out.println(" and at end of method one is: " + one);
    }
}
```

**Figure 8-11** The `PassArrayElement` class



```
C:\Java>java PassArrayElement
At start of main: 5 10 15 20
At start of method one is: 5 and at end of method one is: 999
At start of method one is: 10 and at end of method one is: 999
At start of method one is: 15 and at end of method one is: 999
At start of method one is: 20 and at end of method one is: 999
At end of main: 5 10 15 20

C:\Java>
```

Figure 8-12 Output of the PassArrayElement application

As you can see in Figure 8-12, the four numbers that were changed in the `methodGetsOneInt()` method remain unchanged back in `main()` after the method executes. The variable named `one` is local to the `methodGetsOneInt()` method, and any changes to variables passed into the method are not permanent and are not reflected in the array in the `main()` program. Each variable named `one` in the `methodGetsOneInt()` method holds only a copy of the array element passed into the method. The individual array elements are **passed by value**; that is, a copy of the value is made and used within the receiving method. When any primitive type (`boolean`, `char`, `byte`, `short`, `int`, `long`, `float`, or `double`) is passed to a method, the value is passed.

Arrays, like all nonprimitive objects, are **reference types**; this means that the object actually holds a memory address where the values are stored. Because an array name is a reference, you cannot assign another array to it using the `=` operator, nor can you compare two arrays using the `==` operator. Additionally, when you pass an array (that is, pass its name) to a method, the receiving method gets a copy of the array's actual memory address. This means that the receiving method has access to, and the ability to alter, the original values in the array elements in the calling method.

The class shown in Figure 8-13 creates an array of four integers. After the integers are displayed, the array name (its address) is passed to a method named `methodGetsArray()`. Within the method, the numbers are displayed, which shows that they retain their values from `main()`, but then the value 888 is assigned to each number. Even though `methodGetsArray()` is a void method—meaning nothing is returned to the `main()` method—when the `main()` method displays the array for the second time, all of the values have been changed to 888, as you can see in the output in Figure 8-14. Because the method receives a reference to the array, the `methodGetsArray()` method “knows” the address of the array declared in `main()` and makes its changes directly to the original array.



In some languages, arrays are **passed by reference**, meaning that a receiving method gets the memory address. It is a subtle distinction, but in Java, the receiving method gets a copy of the original address. In other words, in Java, an array is not passed by reference, but a reference to an array is passed by value.

```
public class PassArray
{
    public static void main(String[] args)
    {
        final int NUM_ELEMENTS = 4;
        int[] someNums = {5, 10, 15, 20};
        int x;
        System.out.print("At start of main: ");
        for(x = 0; x < NUM_ELEMENTS; ++x)
            System.out.print(" " + someNums[x] );
        System.out.println();
        methodGetsArray(someNums);
        System.out.print("At end of main: ");
        for(x = 0; x < NUM_ELEMENTS; ++x)
            System.out.print(" " + someNums[x]);
        System.out.println();
    }
    public static void methodGetsArray(int[] arr)
    {
        int x;
        System.out.print("At start of method arr holds: ");
        for(x = 0; x < arr.length; ++x)
            System.out.print(" " + arr[x] );
        System.out.println();
        for(x = 0; x < arr.length; ++x)
            arr[x] = 888;
        System.out.print(" and at end of method arr holds: ");
        for(x = 0; x < arr.length; ++x)
            System.out.print(" " + arr[x] );
        System.out.println();
    }
}
```

Figure 8-13 The PassArray class

Notice that in the first shaded statement in Figure 8-13, the array name is passed to the method and no brackets are used. In the method header, brackets are used to show that the parameter is an array of integers (a reference) and not a simple `int`.

```
ca. Command Prompt
C:\Java>java PassArray
At start of main: 5 10 15 20
At start of method arr holds: 5 10 15 20
and at end of method arr holds: 888 888 888 888
At end of main: 888 888 888 888
C:\Java>
```

Figure 8-14 Output of the PassArray application



In some other languages, notably C, C++, and C#, you can choose to pass variables to methods by value or reference. In Java, you cannot make this choice. Primitive type variables are always passed by value. When you pass an object, a copy of the reference to the object is always passed.

## Returning an Array from a Method

A method can return an array reference. When a method returns an array reference, you include square brackets with the return type in the method header. For example, Figure 8-15 shows a `getArray()` method that returns a locally declared array of `ints`. Square brackets are used as part of the return type; the `return` statement returns the array name without any brackets.

```
public static int[] getArray()
{
    int[] scores = {90, 80, 70, 60};
    return scores;
}
```

**Figure 8-15** The `getArray()` method



Watch the video *Arrays and Methods*.

### TWO TRUTHS & A LIE

#### Passing Arrays to and Returning Arrays from Methods

1. You pass a single array element to a method using its name, and the method must be prepared to receive the appropriate data type.
2. You pass an array to a method using its name followed by a pair of brackets; arrays are passed by value.
3. When a method returns an array reference, you include square brackets with the return type in the method header.

The false statement is #2. You pass an array to a method using its name; a copy of the array's address is passed to the method.

## You Do It

### Creating and Populating an Array

In this section, you will create a small array to see how arrays are used. The array will hold salaries for four categories of employees.

#### To create a program that uses an array:

1. Open a new text file in your text editor.
2. Begin the class that demonstrates how arrays are used by typing the following class and `main()` headers and their corresponding opening curly braces:

```
public class DemoArray
{
    public static void main(String[] args)
    {
```

3. On a new line, declare and create an array that can hold four `double` values by typing the following:

```
double[] salary = new double[4];
```

4. One by one, assign four values to the four salary array elements by typing the following:

```
salary[0] = 6.25;
salary[1] = 6.55;
salary[2] = 10.25;
salary[3] = 16.85;
```

5. To confirm that the four values have been assigned, display the salaries one by one using the following code:

```
System.out.println("Salaries one by one are:");
System.out.println(salary[0]);
System.out.println(salary[1]);
System.out.println(salary[2]);
System.out.println(salary[3]);
```

6. Add the two closing curly braces that end the `main()` method and the `DemoArray` class.

7. Save the program as **DemoArray.java**. Compile and run the program. The program's output appears in Figure 8-16.

### Initializing an Array

Next, you will alter your `DemoArray` program to initialize the array of `doubles`, rather than declaring the array and assigning values later.



```
Command Prompt
C:\Java>java DemoArray
Salaries one by one are:
6.25
6.55
10.25
16.85
C:\Java>
```

**Figure 8-16** Output of the `DemoArray` application

### To initialize an array of doubles:

1. Open the **DemoArray.javan** file in your text editor. Immediately save the file as **DemoArray2.java**. Change the class name to **DemoArray2**. Delete the statement that declares the array of four `double`s named `salary`, and then replace it with the following initialization statement:

```
double[] salary = {6.25, 6.55, 10.25, 16.85};
```

2. Delete the following four statements that individually assign the values to the array:

```
salary[0] = 6.25; salary[1] = 6.55; salary[2] = 10.25;  
salary[3] = 16.85;
```

3. Save the file (as **DemoArray2.java**), compile, and test the application. The values that are output are the same as those shown for the `DemoArray` application in Figure 8-16.

## Using a for Loop to Access Array Elements

Next, you will modify the `DemoArray2` program to use a `for` loop with the array.

### To use a for loop with the array:

1. Open the **DemoArray2.java** file in your text editor. Immediately save the file as **DemoArray3.java**. Change the class name to **DemoArray3**. Delete the four `println()` statements that display the four array values, and then replace them with the following `for` loop:

```
for(int x = 0; x < salary.length; ++x)  
    System.out.println(salary[x]);
```

2. Save the program (as **DemoArray3.java**), compile, and run the program. Again, the output is the same as that shown in Figure 8-16.

## Creating Parallel Arrays to Eliminate Nested if Statements

Next, you will create an `Event` class for an organization that plans parties. The class contains three data fields: an integer representing the type of event, a `double` representing the rate that is charged for the event, and a `String` that holds the event manager's name. The class also contains methods to get and set the field values. You will create a constructor that bases field values on data stored in parallel arrays.

### To create the Event class:

1. Open a new file in your text editor and create the `Event` class, as shown in Figure 8-17. Save the file as **Event.java**. Alternatively, you can use the `Event.java` class file you created in Chapter 5.

```
public class Event
{
    private int typeOfEvent;
    private double rate;
    private String manager;
    public int getType()
    {
        return typeOfEvent;
    }
    public double getRate()
    {
        return rate;
    }
    public String getManager()
    {
        return manager;
    }
    public void setType(int eventType)
    {
        typeOfEvent = eventType;
    }
    public void setRate(double eventRate)
    {
        rate = eventRate;
    }
    public void setManager(String managerName)
    {
        manager = managerName;
    }
}
```

**Figure 8-17** The Event class

2. Add a constructor to the Event class. The constructor requires an argument for the event type; the constructor uses it to determine the rate charged and the manager's name for the event. Table 8-2 shows the appropriate values based on the event type. Although with only three event types it would be relatively easy to make assignments using nested if statements, the constructor will use arrays to hold the possible field values. That way, when event types are added in the future, the only necessary change will be to add the data that corresponds to the new type of event. Also notice two features when you examine the constructor code:

  - The event types are 1, 2, and 3, but arrays begin with element 0, so the 0 position of the `rateSchedule` and `managerList` arrays is reserved for error codes—a rate of 0 and a manager name of "X".
  - If the event code passed to the constructor is too high, it is forced to 0 before the arrays are accessed to assign rates and manager names.

| Event Type Code | Event Type | Manager         | Rate (\$) |
|-----------------|------------|-----------------|-----------|
| 1               | Private    | Dustin Britt    | 47.99     |
| 2               | Corporate  | Carmen Lindsey  | 75.99     |
| 3               | Nonprofit  | Robin Armanetti | 40.99     |

**Table 8-2** Events, managers, and rates charged per person

```
public Event(int eType)
{
    double[] rateSchedule = {0.0, 47.99, 75.99, 40.99};
    String[] managerList = {"X", "Dustin Britt",
        "Carmen Lindsey", "Robin Armanetti"};
    typeOfEvent = eType;
    if(eType > rateSchedule.length)
        eType = 0;
    rate = rateSchedule[eType];
    manager = managerList[eType];
}
```

3. Save the **Event.java** file and compile it.

## Creating an Application with an Array of Objects

Next, you will create an application that can hold an array of `Event` class objects.

### To create an application that holds an array of objects:

1. Open a new text file in your text editor to create an `EventArrayDemo` application.
2. Type the following class header, the `main()` method header, and their opening curly braces:

```
public class EventArrayDemo
{
    public static void main(String[] args)
    {
```

3. Declare an array of five `Event` objects using the following code. You also declare an integer that can be used as a subscript:

```
Event[] someEvents = new Event[5];
int x;
```

4. Enter the following for loop that calls the `Event` constructor five times, making each `Event` type 1:

```
for(x = 0; x < someEvents.length; ++x)
    someEvents[x] = new Event(1);
```



- To confirm that the Event objects have been created and initialized with the default event type, display their values by typing the following:

```
for(x = 0; x < someEvents.length; ++x)
    System.out.println(someEvents[x].getType() +
        " " + someEvents[x].getRate() +
        " " + someEvents[x].getManager());
```

- Add the two curly braces that end the main() method and the class definition.
- Save the program as **EventArrayDemo.java**. Compile and run the application. Figure 8-18 shows the program's output, in which five type 1 Events are displayed.



```

C:\Java>java EventArrayDemo
1 47.99 Dustin Britt
1 47.99 Dustin Britt
1 47.99 Dustin Britt
1 47.99 Dustin Britt
1 47.99 Dustin Britt
C:\Java>
```

**Figure 8-18** Output of the EventArrayDemo application

## Creating an Interactive Application That Creates an Array of Objects

An array of five Event objects—each of which has the same event type and fee—is not very interesting or useful. Next, you will create an EventArrayDemo2 application that creates the events interactively so that each event possesses unique properties.

### To create an interactive EventArrayDemo2 program:

- Open a new file in your text editor and enter the following code to begin the class. The main() method contains an array of Strings describing the event types and two more Strings; the first of these Strings is used to construct a choicesString prompt, and the second is used to accept the user's response from the keyboard. In addition, you include an integer to hold the selected event number, an array of five Event objects, and an integer to be used as a subscript when accessing arrays:

```
import javax.swing.*;
public class EventArrayDemo2
{
    public static void main(String[] args)
    {
        String[] eventTypes = {"", "Private", "Corporate",
            "Non-profit"};
        String choicesString = "";
        String strSelectedEvent;
        int selectedEvent;
        Event[] someEvents = new Event[5];
        int x;
```

2. Add a for loop that builds the `String` to be used as part of the prompt for the user, listing the available choices for event types. Instead of this loop, you could declare a `String` as `"1 Private\n2 Corporate\n3 Non-profit"` and the results would be identical. However, by creating the `String` in a loop, you avoid being required to change this prompt if the event type codes and names are altered in the future. Also notice that this loop begins with `x = 1` because you do not want to display the 0 option:

```
for(x = 1; x < eventTypes.length; ++x)
    choicesString = choicesString + "\n" + x + " " +
        eventTypes[x];
```

3. The next for loop executes one time for each `Event` object that is instantiated. It prompts the user, converts the user's choice to an integer, forces the choice to 0 if it is invalid, and finally creates the object:

```
for(x = 0; x < someEvents.length; ++x)
{
    strSelectedEvent = JOptionPane.showInputDialog(null,
        "Event #" + (x + 1) +
        " Enter the number for the type of event you want" +
        choicesString);
    selectedEvent = Integer.parseInt(strSelectedEvent);
    if(selectedEvent < 1 || selectedEvent > 3)
        selectedEvent = 0;
    someEvents[x] = new Event(selectedEvent);
}
```

4. The last for loop lists the details of each created `Event`:

```
for(x = 0; x < someEvents.length; ++x)
    System.out.println(someEvents[x].getType() +
        " " + eventTypes[someEvents[x].getType()] +
        " " + someEvents[x].getRate() +
        " " + someEvents[x].getManager());
```

5. Add the two closing curly braces—one for the `main()` method and the other for the class.
6. Save the file as `EventArrayDemo2.java`. Compile and execute the application. Provide an event number at each prompt and confirm that the correct objects are created. For example, Figure 8-19 shows the output when the user enters 0, 1, 2, 3, and 4 in that order for the event types. Notice that the last event type has been forced to 0 because an invalid entry (4) was made.

```

C:\Java>java EventArrayDemo2
0 0.0 X
1 Private 47.99 Dustin Britt
2 Corporate 75.99 Carmen Lindsey
3 Non-profit 40.99 Robin Armanetti
0 0.0 X

C:\Java>

```

**Figure 8-19** Output of the EventArrayDemo2 application

## Passing an Array to a Method

Next, you will add a new method to the EventArrayDemo2 application that increases the rate for each Event. This application demonstrates that changes made to a passed array within a method permanently affect values in the array.

### To add a new method to the class:

1. In your text editor, open the **EventArrayDemo2.java** file if it is not already open. Immediately save the file as **EventArrayDemo3.java**. Change the class name to match the filename.
2. Just before the closing curly brace for the class, add the following method that accepts two arguments—an array of Event objects and an amount by which each Event rate should be increased. Within the method, each array element is processed in a for loop that executes as many times as there are elements in the array. With each element, you use the `getRate()` method of the Event class to retrieve the Event current rate, add a fixed amount to it, and return the sum to the class field using the Event class `setRate()` method.

```

public static void increaseFees(Event[] e, double increaseAmt)
{
    int x;
    for(x = 0; x < e.length; ++x)
        e[x].setRate(e[x].getRate() + increaseAmt);
}

```

3. After the final for loop in the existing class, add the following statement, which calls the `increaseFees()` method, passing the array of Event objects and a flat \$100.00 per event increase:

```

increaseFees(someEvents, 100.00);

```

4. On the next lines, add a statement that heads the list of Events after the increases have taken place, and then displays all the Event details in a loop.

```

System.out.println("After increases: ");
for(x = 0; x < someEvents.length; ++x)
    System.out.println(someEvents[x].getType() +
        " " + eventTypes[someEvents[x].getType()] +
        " " + someEvents[x].getRate() +
        " " + someEvents[x].getManager());

```



If you do not want to type this last `println()` statement, you can simply use your text editor's copy function to copy the identical statement that already exists within the program.

5. Save the file, then compile and execute the `EventArrayDemo3` program. The output appears as shown in Figure 8-20 after the user enters 1, 2, 3, 2, and 1 as Event choices. Notice that the changes you made to each Event in the method persist when the Event array is displayed in the `main()` method.

```

C:\Java>java EventArrayDemo3
1 Private 47.99 Dustin Britt
2 Corporate 75.99 Carmen Lindsey
3 Non-profit 40.99 Robin Armanetti
2 Corporate 75.99 Carmen Lindsey
1 Private 47.99 Dustin Britt
After increases:
1 Private 147.99 Dustin Britt
2 Corporate 175.99 Carmen Lindsey
3 Non-profit 140.99 Robin Armanetti
2 Corporate 175.99 Carmen Lindsey
1 Private 147.99 Dustin Britt
C:\Java>

```

Figure 8-20 Typical output of the `EventArrayDemo3` application

## Don't Do It

- Don't forget that the lowest array subscript is 0.
- Don't forget that the highest array subscript is one less than the length of the array.
- Don't forget that `length` is an array property and not a method. Conversely, `length()` is a `String` method, and not a property.
- Don't place a subscript after an object's field or method name when accessing an array of objects. Instead, the subscript for an object follows the object and comes before the dot and the field or method name.
- Don't assume that an array of characters is a string. Although an array of characters can be treated like a string in languages like C++, you can't do this in Java. For example, if you display the name of a character array, you will see its address, not its contents.

- Don't forget that array names are references. Therefore, you cannot assign one array to another using the = operator, nor can you compare arrays using the == operator.
- Don't use brackets with an array name when you pass it to a method. Do use brackets in the method header that accepts the array.

## Key Terms

An **array** is a named list of data items that all have the same type.

A **subscript** is an integer contained within square brackets that indicates one of an array's variables, or elements.

An **element** is one variable or object in an array.

Providing values for all the elements in an array is called **populating the array**.

**Scalar** variables are simple, primitive variables, such as `int`, `double`, or `char`.

The **length field** contains the number of elements in an array.

An object's instance variable or field is also called a **property** of the object.

The **enhanced for loop** allows you to cycle through an array without specifying the starting and ending points for the loop control variable.

A **foreach loop** is an enhanced `for` loop.

**Searching an array** is the process of comparing a value to a list of values in an array, looking for a match.

A **parallel array** is one with the same number of elements as another, and for which the values in corresponding elements are related.

A **range match** is the process of comparing a value to the endpoints of numerical ranges to find a category in which the value belongs.

When a variable is **passed by value** to a method, a copy is made in the receiving method.

Arrays are **reference types**, meaning that the object actually holds a memory address where the values are stored.

When a value is **passed by reference** to a method, the address is passed to the method.

## Chapter Summary

- An array is a named list of data items that all have the same type. You declare an array variable by inserting a pair of square brackets after the type. To reserve memory space for an array, you use the keyword `new`. You use a subscript contained within square brackets to refer to one of an array's variables, or elements. In Java, any array's elements are numbered beginning with zero.
- Array names represent computer memory addresses. When you declare an array name, no computer memory address is assigned to it. Instead, the array variable name has the special value `null`, or Unicode value `'\u0000'`. When you use the keyword `new`, then an array acquires an actual memory address. The default value for elements of a numeric array is 0, `char` array elements are assigned `'\u0000'` by default, and `boolean` array elements automatically are assigned `false`. To initialize an array to nondefault values, you use a list separated by commas and enclosed within curly braces.
- You can shorten many array-based tasks by using a variable as a subscript. When an application contains an array, it is common to perform loops that execute from 0 to one less than the size of the array. The `length` field is an automatically created field that is assigned to every array; it contains the number of elements in the array.
- Just as you can declare arrays of integers or `doubles`, you can declare arrays that hold elements of any type, including `Strings` and other objects. To use a method that belongs to an object that is part of an array, you insert the appropriate subscript notation after the array name and before the dot that precedes the method name.
- By looping through an array and making comparisons, you can search an array to find a match to a value. You can use a parallel array with the same number of elements to hold related elements. You perform a range match by placing end values of a numeric range in an array and making greater-than or less-than comparisons.
- You can pass a single array element to a method in exactly the same manner as you would pass a simple variable, and the array receives a copy of the passed value. However, arrays, like all objects, are reference types; this means that when an array name is passed to a method, the method receives a copy of the array's memory address and has access to the values in the original array.

## Review Questions

1. An array is a list of data items that \_\_\_\_\_.
  - a. all have the same type
  - b. all have different names
  - c. all are integers
  - d. all are `null`
2. When you declare an array, \_\_\_\_\_.
  - a. you always reserve memory for it in the same statement
  - b. you might reserve memory for it in the same statement
  - c. you cannot reserve memory for it in the same statement
  - d. the ability to reserve memory for it in the same statement depends on the type of the array

3. You reserve memory locations for an array when you \_\_\_\_\_.
- declare the array name
  - use the keyword `new`
  - use the keyword `mem`
  - explicitly store values within the array elements
4. For how many integers does the following statement reserve room?  
`int[] value = new int[34];`
- 0
  - 33
  - 34
  - 35
5. Which of the following can be used as an array subscript?
- `character`
  - `double`
  - `int`
  - `String`
6. If you declare an array as follows, how do you indicate the final element of the array?  
`int[] num = new int[6];`
- `num[0]`
  - `num[5]`
  - `num[6]`
  - impossible to tell
7. If you declare an integer array as follows, what is the value of `num[2]`?  
`int[] num = {101, 202, 303, 404, 505, 606};`
- 101
  - 202
  - 303
  - impossible to tell
8. Array names represent \_\_\_\_\_.
- values
  - functions
  - references
  - allusions
9. Unicode value `'\u0000'` is also known as \_\_\_\_\_.
- `nil`
  - `void`
  - `nada`
  - `null`
10. When you initialize an array by giving it values upon creation, you \_\_\_\_\_.
- do not explicitly give the array a size
  - also must give the array a size explicitly
  - must make all the values zero, blank, or `false`
  - must make certain each value is different from the others

11. In Java, you can declare an array of 12 elements and initialize \_\_\_\_\_.  
a. only the first one  
b. all of them  
c. Both of these are true.  
d. Neither of these is true.
12. Assume an array is declared as follows. Which of the following statements correctly assigns the value 100 to each of the array elements?  
`int[] num = new int[4];`  
a. `for(x = 0; x < 3; ++x) num[x] = 100;`  
b. `for(x = 0; x < 4; ++x) num[x] = 100;`  
c. `for(x = 1; x < 4; ++x) num[x] = 100;`  
d. `for(x = 1; x < 5; ++x) num[x] = 100;`
13. Suppose you have declared an array as follows:  
`int[] creditScores = {670, 720, 815};`  
What is the value of `creditScores.length`?  
a. 0  
b. 1  
c. 2  
d. 3
14. If a class named `Student` contains a method `setID()` that takes an `int` argument and you write an application in which you create an array of 20 `Student` objects named `scholar`, which of the following statements correctly assigns an ID number to the first `Student` `scholar`?  
a. `Student[0].setID(1234);`  
b. `scholar[0].setID(1234);`  
c. `Student.setID[0](1234);`  
d. `scholar.setID[0](1234);`
15. A parallel array is one that \_\_\_\_\_.  
a. holds values that correspond to those in another array  
b. holds an even number of values  
c. is placed adjacent to another array in code  
d. is placed adjacent to another array in memory
16. In which of the following situations would setting up parallel arrays be most useful?  
a. You need to look up an employee's ID number to find the employee's last name.  
b. You need to calculate interest earned on a savings account balance.  
c. You need to store a list of 20 commonly misspelled words.  
d. You need to determine the shortest distance between two points on a map.
17. When you pass an array element to a method, the method receives \_\_\_\_\_.  
a. a copy of the array  
b. the address of the array  
c. a copy of the value in the element  
d. the address of the element



18. A single array element of a primitive type is passed to a method by \_\_\_\_\_.
  - a. value
  - b. reference
  - c. address
  - d. osmosis
19. When you pass an array to a method, the method receives \_\_\_\_\_.
  - a. a copy of the array
  - b. a copy of the first element in the array
  - c. the address of the array
  - d. nothing
20. If a method should return an array to its calling method, \_\_\_\_\_.
  - a. the method's return type must match its parameter type
  - b. the return type in the method header is preceded by an ampersand
  - c. the return type in the method header is followed by square brackets
  - d. A Java method cannot return an array.

## Exercises

1. Write an application that can hold five integers in an array. Display the integers from first to last, and then display the integers from last to first. Save the file as **IntArray.java**.
2. Write an application that prompts the user to make a choice for a pizza size—S, M, L, or X—and then displays the price as \$6.99, \$8.99, \$12.50, or \$15.00, accordingly. Display an error message if the user enters an invalid pizza size. Save the file as **PizzaChoice.java**.
3.
  - a. Create a class named **Taxpayer**. Data fields for **Taxpayer** include yearly gross income and Social Security number (use an `int` for the type, and do not use dashes within the Social Security number). Methods include a constructor that requires values for both data fields, and two methods that each return one of the data field values. Write an application named **UseTaxpayer** that declares an array of 10 **Taxpayer** objects. Set each Social Security number to 999999999 and each gross income to zero. Display the 10 **Taxpayer** objects. Save the files as **Taxpayer.java** and **UseTaxpayer.java**.
  - b. Modify your **UseTaxpayer** application so each **Taxpayer** has a successive Social Security number from 1 through 10 and a gross income that ranges from \$10,000 to \$100,000, increasing by \$10,000 for each successive **Taxpayer**. Save the file as **UseTaxpayer2.java**.
4. Create an application containing an array that stores 20 prices, such as \$2.34, \$7.89, \$1.34, and so on. The application should (1) display the sum of all the prices, (2) display all values less than \$5.00, (3) calculate the average of the prices, and (4) display all values that are higher than the calculated average value. Save the file as **Prices.java**.
5.
  - a. Create a **CollegeCourse** class. The class contains fields for the course ID (for example, "CIS 210"), credit hours (for example, 3), and a letter grade (for example, 'A').

- Include `get()` and `set()` methods for each field. Create a `Student` class containing an ID number and an array of five `CollegeCourse` objects. Create a `get()` and `set()` method for the `Student` ID number. Also create a `get()` method that returns one of the `Student`'s `CollegeCourses`; the method takes an integer argument and returns the `CollegeCourse` in that position (0 through 4). Next, create a `set()` method that sets the value of one of the `Student`'s `CollegeCourses`; the method takes two arguments—a `CollegeCourse` and an integer representing the `CollegeCourse`'s position (0 through 4). Save the files as **`CollegeCourse.java`** and **`Student.java`**.
- b. Write an application that prompts a professor to enter grades for five different courses each for 10 students. Prompt the professor to enter data for one student at a time, including student ID and course data for five courses. Use prompts containing the number of the student whose data is being entered and the course number—for example, “Enter ID for student #*s*”, where *s* is an integer from 1 through 10, indicating the student, and “Enter course ID #*n*”, where *n* is an integer from 1 through 5, indicating the course number. Verify that the professor enters only A, B, C, D, or F for the grade value for each course. Save the file as **`InputGrades.java`**.
6. Write an application in which the user can enter a date using digits and slashes (for example, “6/24/2012”), and receive output that displays the date with the month shown as a word (such as “June 24, 2012”). Allow for the fact that the user might or might not precede a month or day number with a zero (for example, the user might type “06/24/2012” or “6/24/2012”). Do not allow the user to enter an invalid date, defined as one for which the month is less than 1 or more than 12, or one for which the day number is less than 1 or greater than the number of days in the specified month. Also display the date's ordinal position in the year; for example, 6/24 is the 176th day. In this application, use your knowledge of arrays to store the month names, as well as values for the number of days in each month so that you can calculate the number of days that have passed. Figure 8-21 shows the output when the user has entered 6/24/2012. Save the application as **`ConvertDate.java`**.



**Figure 8-21** Typical execution of `ConvertDate` application



When determining whether a date is valid and when calculating the number of days that have passed, remember that some years are leap years. In a leap year, February 29th is added to the calendar. A leap year is any year that is evenly divisible by 4, unless the year is also evenly divisible by 100. So 1908 and 2008 were both leap years, but 1900 was not a leap year. Another exception occurs when a year is evenly divisible by 400—the year is a leap year. Therefore, 2000 was a leap year, but 2100 will not be one.

7. a. Write an application that stores vowels (a, e, i, o, and u) in an array. Ask the user to enter a character. Then, the program should indicate whether the entered character is a lowercase vowel. Save the file as **VowelArray.java**.  
b. Modify the `VowelArray` application so that uppercase vowels are also recognized as vowels. Save the file as **VowelArray2.java**.
8. Write an application that allows a user to enter the names and phone numbers of up to 20 friends. Continue to prompt the user for names and phone numbers until the user enters “zzz” or has entered 20 names, whichever comes first. When the user is finished entering names, produce a count of how many names were entered, but make certain not to count the application-ending dummy “zzz” entry. Then display the names. Ask the user to type one of the names and display the corresponding phone number. Save the application as **PhoneBook.java**.
9. Store 20 employee ID numbers in an integer array and 20 corresponding employee last names in a `String` array. Use dialog boxes to accept an ID number, and display the appropriate last name. Save the application as **EmployeeIDArray.java**.
10. Create an array of `Strings`, each containing one of the top 10 reasons that you like Java. Prompt a user to enter a number from 1 to 10, convert the number to an integer, and then use the integer to display one of the reasons. Save the application as **JavaArray.java**.
11. Create an array of five `Strings` containing the first names of people in your family. Write a program that counts and displays the total number of vowels (both uppercase and lowercase) in all five `Strings` that you entered. Save the file as **Vowels.java**.
12. Write an application containing three parallel arrays that hold 10 elements each. The first array holds four-digit student ID numbers, the second holds first names, and the third holds the students’ grade point averages. Use dialog boxes to accept a student ID number and display the student’s first name and grade point average. If a match is not found, display an error message that includes the invalid ID number and allow the user to search for a new ID number. Save the file as **StudentIDArray.java**.
13. A personal phone directory contains room for first names and phone numbers for 30 people. Assign names and phone numbers for the first 10 people. Prompt the user for a name, and if the name is found in the list, display the corresponding phone number. If the name is not found in the list, prompt the user for a phone number, and add the new name and phone number to the list. Continue to prompt the user for names until the user enters “quit”. After the arrays are full (containing 30 names), do not allow the user to add new entries. Save the file as **PhoneNumbers.java**.



## Debugging Exercise

14. Each of the following files in the Chapter.08 folder of your downloadable student files has syntax and/or logic errors. In each case, determine the problem and fix the program. After you correct the errors, save each file using the same filename preceded with Fix. For example, DebugEight1.java will become FixDebugEight1.java.
- DebugEight1.java
  - DebugEight2.java
  - DebugEight3.java
  - DebugEight4.java

378



## Game Zone

15. Write an application that contains an array of 10 multiple-choice quiz questions related to your favorite hobby. Each question contains three answer choices. Also create an array that holds the correct answer to each question—A, B, or C. Display each question and verify that the user enters only A, B, or C as the answer—if not, keep prompting the user until a valid response is entered. If the user responds to a question correctly, display “Correct!”; otherwise, display “The correct answer is” and the letter of the correct answer. After the user answers all the questions, display the number of correct and incorrect answers. Save the file as **Quiz.java**.
16. a. In Chapter 4, you created a **Die** application that randomly “throws” five dice for the computer and five dice for the player. The application displays the values. Modify the application to decide the winner based on the following hierarchy of **Die** values. Any higher combination beats a lower one; for example, five of a kind beats four of a kind.
- ♦ Five of a kind
  - ♦ Four of a kind
  - ♦ Three of a kind
  - ♦ A pair

For this game, the dice values do not count; for example, if both players have three of a kind, it’s a tie, no matter what the values of the three dice are.

Additionally, the game does not recognize a full house (three of a kind plus two of a kind). Figure 8-22 shows a sample execution. Save the application as **FiveDice2.java**.

```
cmd. Command Prompt
C:\Java>java FiveDice2
Computer rolled: 4 1 2 1 6
You rolled: 2 6 4 4 4
Computer has 2 of a kind
You have 3 of a kind
You win
C:\Java>
```

**Figure 8-22** Typical execution of **FiveDice2** application

- b. Improve the `FiveDice2` game so that when both players have the same combination of dice, the higher value wins. For example, two 6s beats two 5s. Figure 8-23 shows an example execution. Save the application as **FiveDice3.java**.



```
C:\Java>java FiveDice3
Computer rolled: 3 2 2 6 1
You rolled: 1 1 4 3 2
Computer has 2 of a kind
You have 2 of a kind
Computer's values are higher - computer wins
C:\Java>
```

**Figure 8-23** Typical execution of `FiveDice3` application

17. a. In Chapter 7, you modified a previously created `Card` class so that each `Card` would hold the name of a suit (“Spades”, “Hearts”, “Diamonds”, or “Clubs”) as well as a value (“Ace”, “King”, “Queen”, “Jack”, or a number value). Now, create an array of 52 `Card` objects, assigning a different value to each `Card`, and display each `Card`. Save the application as **FullDeck.java**.
- b. In Chapter 7, you created a `War2` card game that randomly selects two `Card` objects (one for the player and one for the computer) and declares a winner or a tie based on the card values. Now create a game that plays 26 rounds of `War`, dealing a full deck with no repeated cards. Some hints:
- Start by creating an array of all 52 playing cards, as in Exercise 17a.
  - Select a random number for the deck position of the player’s first card and assign the card at that array position to the player.
  - Move every higher-positioned card in the deck “down” one to fill in the gap. In other words, if the player’s first random number is 49, select the card at position 49, move the card that was in position 50 to position 49, and move the card that was in position 51 to position 50. Only 51 cards remain in the deck after the player’s first card is dealt, so the available-card array is smaller by one.
  - In the same way, randomly select a card for the computer and “remove” the card from the deck.
  - Display the values of the player’s and computer’s cards, compare their values, and determine the winner.
  - When all the cards in the deck are exhausted, display a count of the number of times the player wins, the number of times the computer wins, and the number of ties.

Save the game as **War3.java**.

18. In Chapter 7, you created a Secret Phrase game similar to Hangman, in which the user guesses letters in a partially hidden phrase in an attempt to determine the complete phrase. Modify the program so that:
- The phrase to be guessed is selected randomly from a list of at least 10 phrases.
  - The clue is presented to the user with asterisks replacing letters to be guessed, but with spaces in the appropriate locations. For example, if the phrase to be guessed is “No man is an island,” then the user sees the following as a first clue:  

```
** ** * * * **
```

The spaces provide valuable clues as to where individual words start and end.
  - Make sure that when a user makes a correct guess, all the matching letters are filled in, regardless of case.

Save the game as **SecretPhrase2.java**.

# Advanced Array Concepts

In this chapter, you will:

- ① Sort array elements
- ① Use two-dimensional and other multidimensional arrays
- ① Use the `Arrays` class
- ① Use the `ArrayList` class
- ① Create enumerations

## Sorting Array Elements

**Sorting** is the process of arranging a series of objects in some logical order. When you place objects in order, beginning with the object that has the lowest value, you are sorting in **ascending** order; conversely, when you start with the object that has the largest value, you are sorting in **descending** order.

The simplest possible sort involves two values that are out of order. To place the values in order, you must swap the two values. Suppose that you have two variables—`valA` and `valB`—and further suppose that `valA = 16` and `valB = 2`. To exchange the values of the two variables, you cannot simply use the following code:

```
valA = valB; // 2 goes to valA
valB = valA; // 2 goes to valB
```

If `valB` is 2, after you execute `valA = valB`, both variables hold the value 2. The value 16 that was held in `valA` is lost. When you execute the second assignment statement, `valB = valA`, each variable still holds the value 2.

The solution that allows you to retain both values is to employ a variable to hold `valA`'s value temporarily during the swap:

```
temp = valA; // 16 goes to temp
valA = valB; // 2 goes to valA
valB = temp; // 16 goes to valB
```

Using this technique, `valA`'s value (16) is assigned to the `temp` variable. The value of `valB` (2) is then assigned to `valA`, so `valA` and `valB` are equivalent. Then, the `temp` value (16) is assigned to `valB`, so the values of the two variables finally are swapped.

If you want to sort any two values, `valA` and `valB`, in ascending order so that `valA` is always the lower value, you use the following `if` statement to make the decision whether to swap. If `valA` is more than `valB`, you want to swap the values. If `valA` is not more than `valB`, you do not want to swap the values.

```
if(valA > valB)
{
    temp = valA;
    valA = valB;
    valB = temp;
}
```

Sorting two values is a fairly simple task; sorting more values (`valC`, `valD`, `valE`, and so on) is more complicated. The task becomes manageable when you know how to use an array.

As an example, you might have a list of five numbers that you want to place in ascending order. One approach is to use a method popularly known as a bubble sort. In a **bubble sort**, you continue to compare pairs of items, swapping them if they are out of order, so that the smallest items “bubble” to the top of the list, eventually creating a sorted list. The bubble sort is neither the fastest nor most efficient sorting technique, but it is one of the simplest to comprehend and provides deeper understanding of array element manipulation.



To use a bubble sort, you place the original, unsorted values in an array, such as the following:

```
int[] someNums = {88, 33, 99, 22, 54};
```

You compare the first two numbers; if they are not in ascending order, you swap them. You compare the second and third numbers; if they are not in ascending order, you swap them. You continue down the list. Generically, for any `someNums[x]`, if the value of `someNums[x]` is larger than `someNums[x + 1]`, you want to swap the two values.

With the numbers 88, 33, 99, 22, and 54, the process proceeds as follows:

- Compare 88 and 33. They are out of order. Swap them. The list becomes 33, 88, 99, 22, 54.
- Compare the second and third numbers in the list—88 and 99. They are in order. Do nothing.
- Compare the third and fourth numbers in the list—99 and 22. They are out of order. Swap them. The list becomes 33, 88, 22, 99, 54.
- Compare the fourth and fifth numbers—99 and 54. They are out of order. Swap them. The list becomes 33, 88, 22, 54, 99.

When you reach the bottom of the list, the numbers are not in ascending order, but the largest number, 99, has moved to the bottom of the list. This feature gives the bubble sort its name—the “heaviest” value has sunk to the bottom of the list as the “lighter” values have bubbled to the top.

Assuming `b` and `temp` both have been declared as integer variables, the code so far is as follows:

```
for(b = 0; b < someNums.length - 1; ++b)
    if(someNums[b] > someNums[b + 1])
    {
        temp = someNums[b];
        someNums[b] = someNums[b + 1];
        someNums[b + 1] = temp;
    }
```



Instead of comparing `b` to `someNums.length - 1` on every pass through the loop, it would be more efficient to declare a variable to which you assign `someNums.length - 1` and use that variable in the comparison. That way, the arithmetic is performed just once. That step is omitted here to reduce the number of steps in the example.

Notice that the `for` statement tests every value of `b` from 0 through 3. The array `someNums` contains five integers. The subscripts in the array range in value from 0 through 4. Within the `for` loop, each `someNums[b]` is compared to `someNums[b + 1]`, so the highest legal value for `b` is 3 when array element `b` is compared to array element `b + 1`. For a sort on any size array, the value of `b` must remain less than the array’s length minus 1.

The list of numbers that began as 88, 33, 99, 22, 54 is currently 33, 88, 22, 54, 99. To continue to sort the list, you must perform the entire comparison-swap procedure again.

- Compare the first two values—33 and 88. They are in order; do nothing.
- Compare the second and third values—88 and 22. They are out of order. Swap them so the list becomes 33, 22, 88, 54, 99.
- Compare the third and fourth values—88 and 54. They are out of order. Swap them so the list becomes 33, 22, 54, 88, 99.
- Compare the fourth and fifth values—88 and 99. They are in order; do nothing.

After this second pass through the list, the numbers are 33, 22, 54, 88, and 99—close to ascending order, but not quite. You can see that with one more pass through the list, the values 22 and 33 will swap, and the list is finally placed in order. To fully sort the worst-case list, one in which the original numbers are descending (as out-of-ascending order as they could possibly be), you need to go through the list four times, making comparisons and swaps. At most, you always need to pass through the list as many times as its length minus one. Figure 9-1 shows the entire procedure.

```
for(a = 0; a < someNums.length - 1; ++a)
  for(b = 0; b < someNums.length - 1; ++b)
    if(someNums[b] > someNums[b + 1])
    {
      temp = someNums[b];
      someNums[b] = someNums[b + 1];
      someNums[b + 1] = temp;
    }
```

**Figure 9-1** Ascending bubble sort of the `someNums` array elements



To place the list in descending order, you need to make only one change in the code in Figure 9-1: You change the greater-than sign (`>`) in `if(someNums[b] > someNums[b + 1])` to a less-than sign (`<`).

When you use a bubble sort to sort any array into ascending order, the largest value “falls” to the bottom of the array after you have compared each pair of values in the array one time. The second time you go through the array making comparisons, there is no need to check the last pair of values. The largest value is guaranteed to already be at the bottom of the array. You can make the sort process even more efficient by using a new variable for the inner `for` loop and reducing the value by one on each cycle through the array. Figure 9-2 shows how you can use a new variable named `comparisonsToMake` to control how many comparisons are made in the inner loop during each pass through the list of values to be sorted. In the shaded statement, the `comparisonsToMake` value is decremented by 1 on each pass through the list.

```
int comparisonsToMake = someNums.length - 1;
for(a = 0; a < someNums.length - 1; ++a)
{
    for(b = 0; b < comparisonsToMake; ++b)
    {
        if(someNums[b] > someNums[b + 1])
        {
            temp = someNums[b];
            someNums[b] = someNums[b + 1];
            someNums[b + 1] = temp;
        }
    }
    --comparisonsToMake;
}
```

**Figure 9-2** More efficient ascending bubble sort of the someNums array elements



Your downloadable student files contain an application named `SortDemo` that allows you to enter eight integers. The program uses the code in Figure 9-2 to sort the integers, which are then displayed in ascending order.



Watch the video *Sorting*.

## Sorting Arrays of Objects

You can sort arrays of objects in much the same way that you sort arrays of primitive types. The major difference occurs when you make the comparison that determines whether you want to swap two array elements. When you construct an array of the primitive element type, you compare the two array elements to determine whether they are out of order. When array elements are objects, you usually want to sort based on a particular object field.

Assume you have created a simple `Employee` class, as shown in Figure 9-3. The class holds four data fields and get and set methods for the fields.

```
public class Employee
{
    private int empNum;
    private String lastName;
    private String firstName;
    private double salary;
    public int getEmpNum()
    {
        return empNum;
    }
    public void setEmpNum(int emp)
    {
        empNum = emp;
    }
    public String getLastName()
    {
        return lastName;
    }
    public void setLastName(String name)
    {
        lastName = name;
    }
    public String getFirstName()
    {
        return firstName;
    }
    public void setFirstName(String name)
    {
        firstName = name;
    }
    public double getSalary()
    {
        return salary;
    }
    public void setSalary(double sal)
    {
        salary = sal;
    }
}
```

**Figure 9-3** The Employee class

You can write a program that contains an array of five Employee objects using the following statement:

```
Employee[] someEmps = new Employee[5];
```

Assume that after you assign employee numbers and salaries to the Employee objects, you want to sort the Employees in salary order. You can pass the array to a `bubbleSort()` method that is prepared to receive Employee objects. Figure 9-4 shows the method.

```

public static void bubbleSort(Employee[] array)
{
    int a, b;
    Employee temp;
    int highSubscript = array.length - 1;
    for(a = 0; a < highSubscript; ++a)
        for(b = 0; b < highSubscript; ++b)
            if(array[b].getSalary() > array[b + 1].getSalary())
            {
                temp = array[b];
                array[b] = array[b + 1];
                array[b + 1] = temp;
            }
}

```

**Figure 9-4** The `bubbleSort()` method that sorts `Employee` objects by their salaries

Examine Figure 9-4 carefully and notice that the `bubbleSort()` method is very similar to the `bubbleSort()` method you use for an array of any primitive type, but there are three major differences:

- The `bubbleSort()` method header shows that it receives an array of type `Employee`.
- The `temp` variable created for swapping is type `Employee`. The `temp` variable will hold an `Employee` object, not just one number or one field. It is important to note that even though only employee salaries are compared, you do not just swap employee salaries. You do not want to substitute one employee's salary for another's. Instead, you swap each `Employee` object's `empNum` and `salary` as a unit.
- The comparison for determining whether a swap should occur uses method calls to the `getSalary()` method to compare the returned salary for each `Employee` object in the array with the salary of the adjacent `Employee` object.

## TWO TRUTHS & A LIE

### Sorting Array Elements

1. In an ascending bubble sort, you compare pairs of items, swapping them if they are out of order, so that the largest items “bubble” to the top of the list, eventually creating a sorted list.
2. When you sort objects, you usually want to sort based on a particular object field.
3. When you make a swap while sorting an array of objects, you typically swap entire objects and not just the field on which the comparison is made.

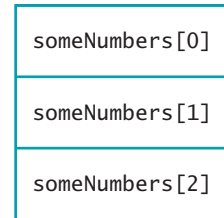
The false statement is #1. In an ascending bubble sort, you compare pairs of items, swapping them if they are out of order, so that the smallest items “bubble” to the top of the list, eventually creating a sorted list.

## Using Two-Dimensional and Other Multidimensional Arrays

388

When you declare an array such as `int[] someNumbers = new int[3];`, you can envision the three declared integers as a column of numbers in memory, as shown in Figure 9-5. In other words, you can picture the three declared numbers stacked one on top of the next. An array that you can picture as a column of values, and whose elements you can access using a single subscript, is a **one-dimensional** or **single-dimensional array**. You can think of the size of the array as its height.

Java also supports two-dimensional arrays. **Two-dimensional arrays** have two or more columns of values, as shown in Figure 9-6. The two dimensions represent the height and width of the array. Another way to picture a two-dimensional array is as an array of arrays. It is easiest to picture two-dimensional arrays as having both rows and columns. You must use two subscripts when you access an element in a two-dimensional array. When mathematicians use a two-dimensional array, they often call it a **matrix** or a **table**; you might have used a two-dimensional array called a spreadsheet.



**Figure 9-5** View of a single-dimensional array in memory

|                   |                   |                   |                   |
|-------------------|-------------------|-------------------|-------------------|
| someNumbers[0][0] | someNumbers[0][1] | someNumbers[0][2] | someNumbers[0][3] |
| someNumbers[1][0] | someNumbers[1][1] | someNumbers[1][2] | someNumbers[1][3] |
| someNumbers[2][0] | someNumbers[2][1] | someNumbers[2][2] | someNumbers[2][3] |

**Figure 9-6** View of a two-dimensional array in memory

When you declare a one-dimensional array, you type a set of square brackets after the array's data type. To declare a two-dimensional array in Java, you type two sets of brackets after the array type. For example, the array in Figure 9-6 can be declared as follows, creating an array named `someNumbers` that holds three rows and four columns:

```
int[][] someNumbers = new int[3][4];
```

Just as with a one-dimensional array, if you do not provide values for the elements in a two-dimensional numeric array, the values default to zero. You can assign other values to the array elements later. For example, `someNumbers[0][0] = 14;` assigns the value 14 to the element of the `someNumbers` array that is in the first column of the first row. Alternatively, you can initialize a two-dimensional array with values when it is created. For example, the following code assigns values to `someNumbers` when it is created:

```
int[][] someNumbers = {
    {8, 9, 10, 11},
    {1, 3, 12, 15},
    {5, 9, 44, 99} };
```

The `someNumbers` array contains three rows and four columns. You do not need to place each row of values for a two-dimensional array on its own line. However, doing so makes the positions of values easier to understand. You contain the entire set of values within an outer pair of curly braces. The first row of the array holds the four integers 8, 9, 10, and 11. Notice that these four integers are placed within their own inner set of curly braces to indicate that they constitute one row, or the first row, which is row 0. Similarly, 1, 3, 12, and 15 make up the second row (row 1), which you reference with the subscript 1. Next, 5, 9, 44, and 99 are the values in the third row (row 2), which you reference with the subscript 2. The value of `someNumbers[0][0]` is 8. The value of `someNumbers[0][1]` is 9. The value of `someNumbers[2][3]` is 99. The value within the first set of brackets following the array name always refers to the row; the value within the second brackets refers to the column.

As an example of how useful two-dimensional arrays can be, assume you own an apartment building with four floors—a basement, which you refer to as floor zero, and three other floors numbered one, two, and three. In addition, each of the floors has studio (with no bedroom) and one- and two-bedroom apartments. The monthly rent for each type of apartment is different—the higher the floor, the higher the rent (the view is better), and the rent is higher for apartments with more bedrooms. Table 9-1 shows the rental amounts.

| Floor | Zero Bedrooms | One Bedroom | Two Bedrooms |
|-------|---------------|-------------|--------------|
| 0     | 400           | 450         | 510          |
| 1     | 500           | 560         | 630          |
| 2     | 625           | 676         | 740          |
| 3     | 1000          | 1250        | 1600         |

**Table 9-1** Rents charged (in dollars)

To determine a tenant's rent, you need to know two pieces of information: the floor on which the tenant rents an apartment and the number of bedrooms in the apartment. Within a Java program, you can declare an array of rents using the following code:

```
int[][] rents = { {400, 450, 510},
                  {500, 560, 630},
                  {625, 676, 740},
                  {1000, 1250, 1600} };
```

Assume you declare two integers to hold the floor number and bedroom count, as in the following statement:

```
int floor, bedrooms;
```

Then any tenant's rent can be referred to as `rents[floor][bedrooms]`. Figure 9-7 shows an application that prompts a user for a floor number and number of bedrooms. Figure 9-8 shows a typical execution.

```
import javax.swing.*;
class FindRent
{
    public static void main(String[] args)
    {
        int[][] rents = { {400, 450, 510},
                          {500, 560, 630},
                          {625, 676, 740},
                          {1000, 1250, 1600} };

        String entry;
        int floor;
        int bedrooms;
        entry = JOptionPane.showInputDialog(null,
            "Enter a floor number ");
        floor = Integer.parseInt(entry);
        entry = JOptionPane.showInputDialog(null,
            "Enter number of bedrooms ");
        bedrooms = Integer.parseInt(entry);
        JOptionPane.showMessageDialog(null,
            "The rent for a " + bedrooms +
            " bedroom apartment on floor " + floor +
            " is $" + rents[floor][bedrooms]);
    }
}
```

Figure 9-7 The FindRent class

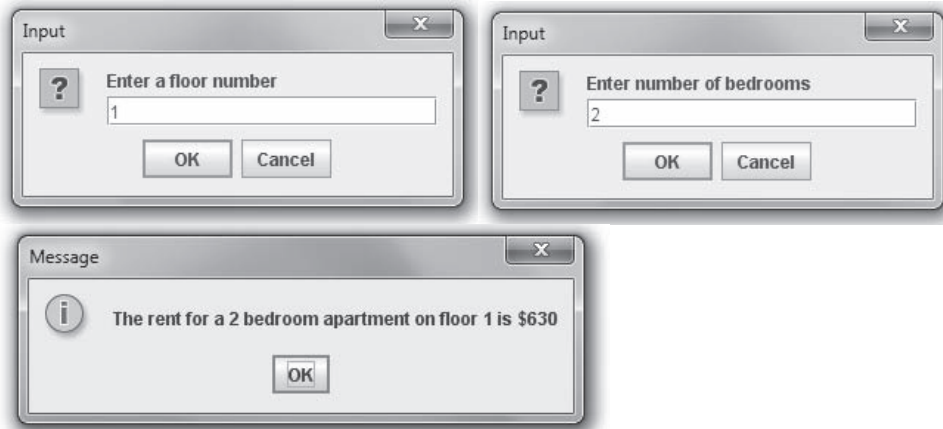


Figure 9-8 Typical execution of the FindRent program

## Passing a Two-Dimensional Array to a Method

When you pass a two-dimensional array to a method, you pass the array name just as you do with a one-dimensional array. A method that receives a two-dimensional array uses two bracket pairs following the data type in the parameter list of the method header. For example,



the following method headers accept two-dimensional arrays of `ints`, `doubles`, and `Employees`, respectively:

```
public static void displayScores(int[][] scoresArray)
public static boolean areAllPricesHigh(double[][] prices)
public static double computePayrollForAllEmployees(Employee[][] staff)
```

In each case, notice that the brackets indicating the array in the method header are empty. There is no need to insert numbers into the brackets because each passed array name is a starting memory address. The way you manipulate subscripts within the method determines how rows and columns are accessed.

## Using the `length` Field with a Two-Dimensional Array

In Chapter 8, you learned that a one-dimensional array has a `length` field that holds the number of elements in the array. With a two-dimensional array, the `length` field holds the number of rows in the array. Each row, in turn, has a `length` field that holds the number of columns in the row. For example, suppose you declare a `rents` array as follows:

```
int[][] rents = { {400, 450, 510},
                 {500, 560, 630},
                 {625, 676, 740},
                 {1000, 1250, 1600} };
```

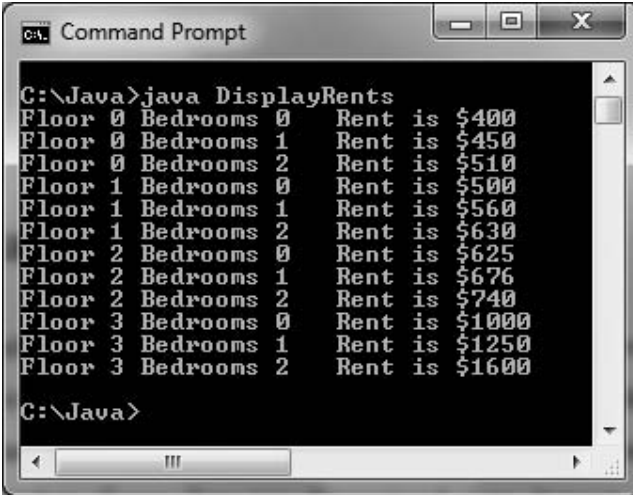
The value of `rents.length` is 4 because there are four rows in the array. The value of `rents[0].length` is 3 because there are three columns in the first row of the `rents` array. Similarly, the value of `rents[1].length` also is 3 because there are three columns in the second row.

Figure 9-9 shows an application that uses the `length` fields associated with the `rents` array to display all the rents. The `floor` variable varies from 0 through one less than 4 in the outer loop, and the `bdrms` variable varies from 0 through one less than 3 in the inner loop. Figure 9-10 shows the output.

```
class DisplayRents
{
    public static void main(String[] args)
    {
        int[][] rents = { {400, 450, 510},
                        {500, 560, 630},
                        {625, 676, 740},
                        {1000, 1250, 1600} };

        int floor;
        int bdrms;
        for(floor = 0; floor < rents.length; ++floor)
            for(bdrms = 0; bdrms < rents[floor].length; ++ bdrms)
                System.out.println("Floor " + floor +
                                   " Bedrooms " + bdrms + " Rent is $" +
                                   rents[floor][bdrms]);
    }
}
```

**Figure 9-9** The `DisplayRents` class



```
C:\Java>java DisplayRents
Floor 0 Bedrooms 0 Rent is $400
Floor 0 Bedrooms 1 Rent is $450
Floor 0 Bedrooms 2 Rent is $510
Floor 1 Bedrooms 0 Rent is $500
Floor 1 Bedrooms 1 Rent is $560
Floor 1 Bedrooms 2 Rent is $630
Floor 2 Bedrooms 0 Rent is $625
Floor 2 Bedrooms 1 Rent is $676
Floor 2 Bedrooms 2 Rent is $740
Floor 3 Bedrooms 0 Rent is $1000
Floor 3 Bedrooms 1 Rent is $1250
Floor 3 Bedrooms 2 Rent is $1600

C:\Java>
```

Figure 9-10 Output of the DisplayRents program



Watch the video *Two-Dimensional Arrays*.

## Understanding Ragged Arrays

In a two-dimensional array, each row is an array. In Java, you can declare each row to have a different length. When a two-dimensional array has rows of different lengths, it is a **ragged array** because you can picture the ends of each row as uneven. You create a ragged array by defining the number of rows for a two-dimensional array, but not defining the number of columns in the rows. For example, suppose you have four sales representatives, each of whom covers a different number of states as their sales territory. Further suppose you want an array to store total sales for each state for each sales representative. You would define the array as follows:

```
double[][] sales = new double[4][];
```

This statement declares an array with four rows, but the rows are not yet created. Then, you can declare the individual rows, based on the number of states covered by each salesperson as follows:

```
sales[0] = new double[12];
sales[1] = new double[18];
sales[2] = new double[9];
sales[3] = new double[11];
```

## Using Other Multidimensional Arrays

Besides one- and two-dimensional arrays, Java also supports arrays with three, four, and more dimensions. The general term for arrays with more than one dimension is **multidimensional arrays**. For example, if you own an apartment building with a number of floors and different

numbers of bedrooms available in apartments on each floor, you can use a two-dimensional array to store the rental fees. If you own several apartment buildings, you might want to employ a third dimension to store the building number. An expression such as `rents [building][floor][bedrooms]` refers to a specific rent figure for a building whose building number is stored in the `building` variable and whose floor and bedroom numbers are stored in the `floor` and `bedrooms` variables. Specifically, `rents[5][1][2]` refers to a two-bedroom apartment on the first floor of building 5. When you are programming in Java, you can use four, five, or more dimensions in an array. As long as you can keep track of the order of the variables needed as subscripts, and as long as you don't exhaust your computer's memory, Java lets you create arrays of any size.

## TWO TRUTHS & A LIE

### Using Two-Dimensional and Other Multidimensional Arrays

1. Two-dimensional arrays have both rows and columns, so you must use two subscripts when you access an element in a two-dimensional array.
2. The following array contains two columns and three rows:
 

```
int[][] myArray = {{12, 14, 19},
                   {33, 45, 88}};
```
3. With a two-dimensional array, the `length` field holds the number of rows in the array; each row has a `length` field that holds the number of columns in the row.

The false statement is #2. The array shown has two rows and three columns.

## Using the Arrays Class

When you fully understand the power of arrays, you will want to use them to store all kinds of objects. Frequently, you will want to perform similar tasks with different arrays—for example, filling them with values and sorting their elements. Java provides an **Arrays class**, which contains many useful methods for manipulating arrays. Table 9-2 shows some of the useful methods of the `Arrays` class. For each method listed in the left column of the table, `type` stands for a data type; an overloaded version of each method exists for each appropriate data type. For example, there is a version of the `sort()` method to sort `int`, `double`, `char`, `byte`, `float`, `long`, `short`, and `Object` arrays.



You will learn about the `Object` class in the chapter *Advanced Inheritance Concepts*.

| Method                                                              | Purpose                                                                                         |
|---------------------------------------------------------------------|-------------------------------------------------------------------------------------------------|
| <code>static int binarySearch(type [] a, type key)</code>           | Searches the specified array for the specified key value using the binary search algorithm      |
| <code>static boolean equals(type[] a, type[] a2)</code>             | Returns <code>true</code> if the two specified arrays of the same type are equal to one another |
| <code>static void fill(type[] a, type val)</code>                   | Assigns the specified value to each element of the specified array                              |
| <code>static void sort(type[] a)</code>                             | Sorts the specified array into ascending order                                                  |
| <code>static void sort(type[] a, int fromIndex, int toIndex)</code> | Sorts the specified range of the specified array into ascending order                           |

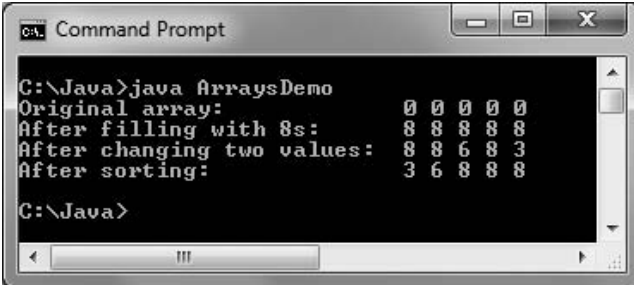
**Table 9-2** Useful methods of the `Arrays` class

The methods in the `Arrays` class are `static` methods, which means you use them with the class name without instantiating an `Arrays` object. The `Arrays` class is located in the `java.util` package, so you can use the statement `import java.util.*;` to access it. The `ArraysDemo` application in Figure 9-11 demonstrates how you can use some of the methods in the `Arrays` class. In the `ArraysDemo` class, the `myScores` array is created to hold five integers. Then, a message and the array reference are passed to a `display()` method. The first line of the output in Figure 9-12 shows that the original array is filled with `0s` at creation. After the first display, the `Arrays.fill()` method is called in the first shaded statement in Figure 9-11. Because the arguments are the name of the array and the number `8`, when the array is displayed a second time the output is all `8s`. In the application, two of the array elements are changed to `6` and `3`, and the array is displayed again. Finally, in the second shaded statement, the `Arrays.sort()` method is called. The output in Figure 9-12 shows that when the `display()` method executes the fourth time, the array elements have been sorted in ascending order.

```
import java.util.*;
public class ArraysDemo
{
    public static void main(String[] args)
    {
        int[] myScores = new int[5];
        display("Original array:           ", myScores);
        Arrays.fill(myScores, 8);
        display("After filling with 8s:      ", myScores);
        myScores[2] = 6;
        myScores[4] = 3;
        display("After changing two values: ", myScores);
        Arrays.sort(myScores);
        display("After sorting:                ", myScores);
    }

    public static void display(String message, int array[])
    {
        int sz = array.length;
        System.out.print(message);
        for(int x = 0; x < sz; ++x)
            System.out.print(array[x] + " ");
        System.out.println();
    }
}
```

Figure 9-11 The ArraysDemo application



```
C:\Java>java ArraysDemo
Original array:           0 0 0 0 0
After filling with 8s:      8 8 8 8 8
After changing two values: 8 8 6 8 3
After sorting:             3 6 8 8 8
C:\Java>
```

Figure 9-12 Output of the ArraysDemo application

The Arrays class `binarySearch()` methods provide convenient ways to search through sorted lists of values of various data types. It is important that the list be in order before you use it in a call to `binarySearch()`; otherwise, the results are unpredictable. You do not have to understand how a binary search works to use the `binarySearch()` method, but basically the operation takes place as follows:

- You have a sorted array and an item for which you are searching within the array. Based on the array size, you determine the middle position. (In an array with an even number of elements, this can be either of the two middle positions.)
- You compare the item you are looking for with the element in the middle position of the array and decide whether your item is above that point in the array—that is, whether your item’s value is less than the middle-point value.
- If it is above that point in the array, you next find the middle position of the top half of the array; if it is not above that point, you find the middle position of the bottom half. Either way, you compare your item with that of the new middle position and divide the search area in half again.
- Ultimately, you find the element or determine that it is not in the array.



Programmers often refer to a binary search as a “divide and conquer” procedure. If you have ever played a game in which you tried to guess what number someone was thinking, you might have used a similar technique.

Suppose your organization uses six single-character product codes. Figure 9-13 contains a `VerifyCode` application that verifies a product code entered by the user. The array `codes` holds six values in ascending order. The user enters a code that is extracted from the first `String` position using the `String` class `charAt()` method. Next, the array of valid characters and the user-entered character are passed to the `Arrays.binarySearch()` method. If the character is found in the array, its position is returned. If the character is not found in the array, a negative integer is returned and the application displays an error message. Figure 9-14 shows the program’s execution when the user enters `K`; the character is found in position 2 (the third position) in the array.



The negative integer returned by the `binarySearch()` method when the value is not found is the negative equivalent of the array size. In most applications, you do not care about the exact value returned when there is no match, but only whether it is negative.

```
import java.util.*;
import javax.swing.*;
public class VerifyCode
{
    public static void main(String[] args)
    {
        char[] codes = {'B', 'E', 'K', 'M', 'P', 'T'};
        String entry;
        char usersCode;
        int position;
        entry = JOptionPane.showInputDialog(null,
            "Enter a product code");
        usersCode = entry.charAt(0);
        position = Arrays.binarySearch(codes, usersCode);
        if(position >= 0)
            JOptionPane.showMessageDialog(null, "Position of " +
                usersCode + " is " + position);
        else
            JOptionPane.showMessageDialog(null, usersCode +
                " is an invalid code");
    }
}
```

Figure 9-13 The VerifyCode application

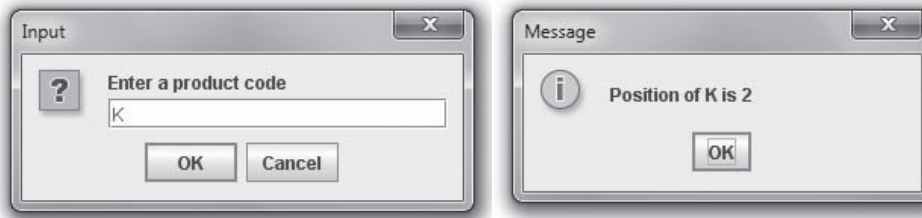


Figure 9-14 Typical execution of the VerifyCode application



The `sort()` and `binarySearch()` methods in the `Arrays` class are very useful and allow you to achieve results by writing many fewer instructions than if you had to write the methods yourself. This does not mean you wasted your time reading about sorting and searching methods earlier in this chapter. The more completely you understand how arrays can be manipulated, the more useful, efficient, and creative your future applications will be.

## TWO TRUTHS & A LIE

### Using the Arrays Class

1. The Arrays class contains methods for manipulating arrays, such as `binarySearch()`, `fill()`, and `sort()`.
2. You can use the Arrays class `binarySearch()` method successfully on any array as soon as you have assigned values to the array elements.
3. The `binarySearch()` method works by continuously deciding whether the element sought is above or below the halfway point in sublists of the original list.

The false statement is #2. Before you can use the Arrays class `binarySearch()` method successfully, the array elements must be in order.

## Using the ArrayList Class

In addition to the Arrays class, Java provides an **ArrayList class** which can be used to create containers that store lists of objects. The ArrayList class provides some advantages over the Arrays class. Specifically, an ArrayList is **dynamically resizable**, meaning that its size can change during program execution. This means that:

- You can add an item at any point in an ArrayList container, and the array size expands automatically to accommodate the new item.
- You can remove an item at any point in an ArrayList container, and the array size contracts automatically.

To use the ArrayList class, you must use one of the following import statements:

```
import java.util.ArrayList;  
import java.util.*;
```

Then, to declare an ArrayList, you can use the default constructor, as in the following example:

```
ArrayList names = new ArrayList();
```

The default constructor creates an ArrayList with a capacity of 10 items. An ArrayList's **capacity** is the number of items it can hold without having to increase its size. By definition, an ArrayList's capacity is greater than or equal to its size. You can also specify a capacity if you like. For example, the following statement declares an ArrayList that can hold 20 names:

```
ArrayList names = new ArrayList(20);
```

If you know you will need more than 10 items at the outset, it is more efficient to create an ArrayList with a larger capacity.

Table 9-3 summarizes some useful ArrayList methods.



| Method                                                                            | Purpose                                                                                                                                                                                      |
|-----------------------------------------------------------------------------------|----------------------------------------------------------------------------------------------------------------------------------------------------------------------------------------------|
| <code>public void add(Object)</code><br><code>public void add(int, Object)</code> | Adds an item to an <code>ArrayList</code> ; the default version adds an item at the next available location; an overloaded version allows you to specify a position at which to add the item |
| <code>public void remove(int)</code>                                              | Removes an item from an <code>ArrayList</code> at a specified location                                                                                                                       |
| <code>public void set(int, Object)</code>                                         | Alters an item at a specified <code>ArrayList</code> location                                                                                                                                |
| <code>Object get(int)</code>                                                      | Retrieves an item from a specified location in an <code>ArrayList</code>                                                                                                                     |
| <code>public int size()</code>                                                    | Returns the current <code>ArrayList</code> size                                                                                                                                              |

**Table 9-3** Useful methods of the `ArrayList` class



In the chapter *Advanced Inheritance Concepts*, you will learn that the `Object` class is the most generic Java class.

To add an item to the end of an `ArrayList`, you can use the `add()` method. For example, to add the name *Abigail* to an `ArrayList` named `names`, you can make the following statement:

```
names.add("Abigail");
```

You can insert an item into a specific position in an `ArrayList` by using an overloaded version of the `add()` method that includes the position. For example, to insert the name *Bob* in the first position of the `names` `ArrayList`, you use the following statement:

```
names.add(0, "Bob");
```



With each of the methods described in this section, you receive an error message if the position number is invalid for the `ArrayList`.

As you can see from Table 9-3, you also can alter and remove items from an `ArrayList`. The `ArrayList` class contains a `size()` method that returns the current size of the `ArrayList`. Figure 9-15 contains a program that demonstrates each of these methods.

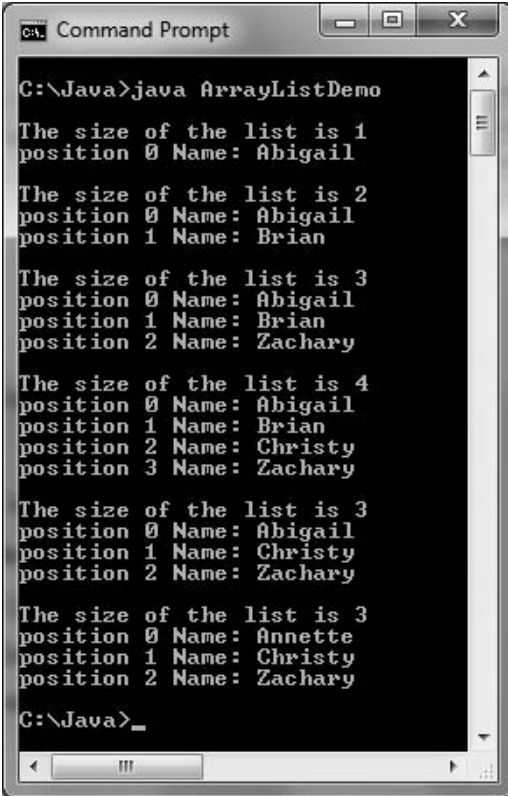
```
import java.util.ArrayList;
public class ArrayListDemo
{
    public static void main(String[] args)
    {
        ArrayList names = new ArrayList();
        names.add("Abigail");
        display(names);
        names.add("Brian");
        display(names);
        names.add("Zachary");
        display(names);
        names.add(2, "Christy");
        display(names);
        names.remove(1);
        display(names);
        names.set(0, "Annette");
        display(names);
    }
    public static void display(ArrayList names)
    {
        System.out.println("\nThe size of the list is " + names.size());
        for(int x = 0; x < names.size(); ++x)
            System.out.println("position " + x + " Name: " +
                names.get(x));
    }
}
```

**Figure 9-15** The ArrayListDemo program



When you compile the ArrayListDemo program, you receive a compiler warning indicating that the program uses unchecked or unsafe operations. You will learn how to eliminate this message in the next section.

In the application in Figure 9-15, an ArrayList is created and *Abigail* is added to the list. The ArrayList is passed to a display() method that displays the current list size and all the names in the list. You can see from the output in Figure 9-16 that at this point, the ArrayList size is 1, and the array contains just one name. Examine the program in Figure 9-15 along with the output in Figure 9-16 so that you understand how the ArrayList is altered as names are added, removed, and replaced.



```
ca. Command Prompt
C:\Java>java ArrayListDemo
The size of the list is 1
position 0 Name: Abigail
The size of the list is 2
position 0 Name: Abigail
position 1 Name: Brian
The size of the list is 3
position 0 Name: Abigail
position 1 Name: Brian
position 2 Name: Zachary
The size of the list is 4
position 0 Name: Abigail
position 1 Name: Brian
position 2 Name: Christy
position 3 Name: Zachary
The size of the list is 3
position 0 Name: Abigail
position 1 Name: Christy
position 2 Name: Zachary
The size of the list is 3
position 0 Name: Annette
position 1 Name: Christy
position 2 Name: Zachary
C:\Java>_
```

**Figure 9-16** Output of the ArrayListDemo program

You can display the contents of an ArrayList of Strings without looping through the values. For example, Figure 9-17 shows an ArrayList named `students` that the user populates interactively. Displaying the array name as shown in the shaded statement produces a comma-separated list between square brackets. Figure 9-18 shows a typical execution.

```
import javax.swing.*;
import java.util.ArrayList;
public class ArrayListDemo2
{
    public static void main(String[] args)
    {
        ArrayList students = new ArrayList();
        String name;
        final int LIMIT = 4;
        for(int x = 0; x < LIMIT; ++x)
        {
            name = JOptionPane.showInputDialog(null,
                "Enter a student's name");
            students.add(name);
        }
        System.out.println("The names are " + students);
    }
}
```

Figure 9-17 The ArrayListDemo2 class

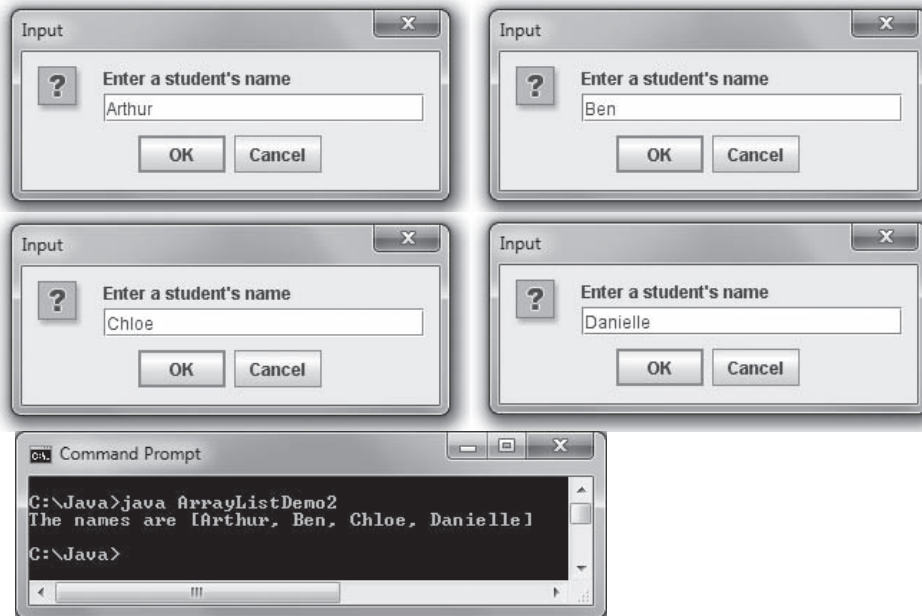


Figure 9-18 Typical execution of the ArrayListDemo2 application



You can achieve similar results using the name for `ArrayList`s of any class type. In Chapter 7, you learned that every class contains a `toString()` method that converts its objects to `Strings`; this method is used when you display an `ArrayList`'s name. However, unless you have overridden the `toString()` method within a class, the `String` that is returned by `toString()` is not very useful. You will learn more about writing this method in the chapter *Advanced Inheritance Concepts*.

You can sort an `ArrayList` using the `Collections.sort()` method and providing the `ArrayList` as the argument—for example:

```
Collections.sort(students);
```

To use this method, you must import the `java.util.Collections` package at the top of the file.

## Understanding the Limitations of the ArrayList Class

An `ArrayList` can be used to store any type of object reference. In fact, one `ArrayList` can store multiple types. However, this creates two drawbacks:

- You cannot use an `ArrayList` to store primitive types such as `int`, `double`, or `char` because those types are not references. If you want to work with primitive types, you can create an array or use the `Arrays` class, but you cannot use the `ArrayList` class.
- When you want to store `ArrayList` elements, you must cast them to the appropriate reference type before you can do so, or you must declare a reference type in the `ArrayList` declaration.

For example, if you want to declare a `String` to hold the first name in the `names` `ArrayList`, you must make statements such as the following:

```
String firstName;  
firstName = (String)names.get(0);
```

The cast operator (`String`) converts the generic returned object from the `get()` method to a `String`. If you do not perform this cast, you receive an error message indicating that you are using incompatible types. (You first learned about the cast operator in Chapter 2.)

You can eliminate the need to perform a cast with `ArrayList` objects by specifying the type that an `ArrayList` can hold. For example, you can declare an `ArrayList` of `names` as follows:

```
ArrayList<String> names = new ArrayList<String>();
```

Creating an `ArrayList` declaration with a specified type provides several advantages:

- You no longer have to use the cast operator when retrieving an item from the `ArrayList`.
- Java checks to make sure that only items of the appropriate type are added to the list.
- The compiler warning that indicates your program uses an unchecked or unsafe operation is eliminated.

## TWO TRUTHS & A LIE

### Using the ArrayList Class

1. An advantage of the ArrayList class over the Arrays class is that an ArrayList is dynamically resizable.
2. An advantage of the ArrayList class over the Arrays class is that it can hold multiple object types.
3. An advantage of the ArrayList class over the Arrays class is that it can hold primitive data types such as int and double.

The false statement is #3. A disadvantage of the ArrayList class is that it cannot hold primitive types.

## Creating Enumerations

Data types have a specific set of values. For example, in Chapter 2 you learned that a byte cannot hold a value larger than 127 and an int cannot hold a value larger than 2,147,483,647. You can also create your own data types that have a finite set of legal values. A programmer-created data type with a fixed set of values is an **enumerated data type**.

In Java, you create an enumerated data type in a statement that uses the keyword `enum`, an identifier for the type, and a pair of curly braces that contain a list of the **enum constants**, which are the allowed values for the type. For example, the following code creates an enumerated type named `Month` that contains 12 values:

```
enum Month {JAN, FEB, MAR, APR, MAY, JUN,  
            JUL, AUG, SEP, OCT, NOV, DEC};
```

By convention, the identifier for an enumerated type begins with an uppercase letter. This convention makes sense because an enumerated type is a class. Also, by convention, the `enum` constants, like other constants, appear in all uppercase letters. The constants are not strings and they are not enclosed in quotes; they are Java identifiers.

After you create an enumerated data type, you can declare variables of that type. For example, you might declare the following:

```
Month birthMonth;
```

You can assign any of the `enum` constants to the variable. Therefore, you can code a statement such as the following:

```
birthMonth = Month.MAY;
```

An enumeration type like `Month` is a class, and its `enum` constants act like objects instantiated from the class, including having access to the methods of the class. These built-in methods

include the ones shown in Table 9-4. Each of these methods is nonstatic; that is, each is used with an enum object.

| Method                   | Description                                                                                                                                                                                                                                                        | Example if <code>birthMonth = Month.MAY</code>                                                                                                                                                               |
|--------------------------|--------------------------------------------------------------------------------------------------------------------------------------------------------------------------------------------------------------------------------------------------------------------|--------------------------------------------------------------------------------------------------------------------------------------------------------------------------------------------------------------|
| <code>toString()</code>  | The <code>toString()</code> method returns the name of the calling constant object.                                                                                                                                                                                | <code>birthMonth.toString()</code> has the value "MAY"<br>You can pass <code>birthMonth</code> to <code>print()</code> or <code>println()</code> and it is automatically converted to its string equivalent. |
| <code>ordinal()</code>   | The <code>ordinal()</code> method returns an integer that represents the constant's position in the list of constants; as with arrays, the first position is 0.                                                                                                    | <code>birthMonth.ordinal()</code> is 4                                                                                                                                                                       |
| <code>equals()</code>    | The <code>equals()</code> method returns <code>true</code> if its argument is equal to the calling object's value.                                                                                                                                                 | <code>birthMonth.equals(Month.MAY)</code> is <code>true</code><br><code>birthMonth.equals(Month.NOV)</code> is <code>false</code>                                                                            |
| <code>compareTo()</code> | The <code>compareTo()</code> method returns a negative integer if the calling object's ordinal value is less than that of the argument, 0 if they are the same, and a positive integer if the calling object's ordinal value is greater than that of the argument. | <code>birthMonth.compareTo(Month.JUL)</code> is negative<br><code>birthMonth.compareTo(Month.FEB)</code> is positive<br><code>birthMonth.compareTo(Month.MAY)</code> is 0                                    |

**Table 9-4** Some useful nonstatic enum methods

Several static methods are also available to use with enumerations. These are used with the type and not with the individual constants. Table 9-5 describes two useful static methods.

| Method                 | Description                                                                                       | Example with Month Enumeration                                                                 |
|------------------------|---------------------------------------------------------------------------------------------------|------------------------------------------------------------------------------------------------|
| <code>valueOf()</code> | The <code>valueOf()</code> method accepts a string parameter and returns an enumeration constant. | <code>Month.valueOf("DEC")</code> returns the DEC enum constant.                               |
| <code>values()</code>  | The <code>values()</code> method returns an array of the enumerated constants.                    | <code>Month.values()</code> returns an array with 12 elements that contain the enum constants. |

**Table 9-5** Some static enum methods

You can declare an enumerated type in its own file, in which case the filename matches the type name and has a .java extension. You will use this approach in a You Do It exercise later in this chapter. Alternatively, you can declare an enumerated type within a class, but not within a method. Figure 9-19 is an application that declares a Month enumeration and demonstrates its use. Figure 9-20 shows two typical executions.

```
import java.util.Scanner;
public class EnumDemo
{
    enum Month {JAN, FEB, MAR, APR, MAY, JUN,
               JUL, AUG, SEP, OCT, NOV, DEC};

    public static void main(String[] args)
    {
        Month birthMonth;
        String userEntry;
        int position;
        int comparison;
        Scanner input = new Scanner(System.in);
        System.out.println("The months are:");
        for(Month mon : Month.values())
            System.out.print(mon + " ");
        System.out.println("\n\nEnter the first three letters of " +
            "your birth month >> ");
        userEntry = input.nextLine().toUpperCase();
        birthMonth = Month.valueOf(userEntry);
        System.out.println("You entered " + birthMonth);
        position = birthMonth.ordinal();
        System.out.println(birthMonth + " is in position " + position);
        System.out.println("So its month number is " + (position + 1));
        comparison = birthMonth.compareTo(Month.JUN);
        if(comparison < 0)
            System.out.println(birthMonth +
                " is earlier in the year than " + Month.JUN);
        else
            if(comparison > 0)
                System.out.println(birthMonth +
                    " is later in the year than " + Month.JUN);
            else
                System.out.println(birthMonth + " is " + Month.JUN);
    }
}
```

Figure 9-19 The EnumDemo class





```
ca. Command Prompt
C:\Java>java EnumDemo
JAN FEB MAR APR MAY JUN JUL AUG SEP OCT NOV DEC
Enter the first three letters of your birth month >> Sep
You entered SEP
SEP is in position 8
So its month number is 9
SEP is later in the year than JUN

C:\Java>java EnumDemo
JAN FEB MAR APR MAY JUN JUL AUG SEP OCT NOV DEC
Enter the first three letters of your birth month >> Feb
You entered FEB
FEB is in position 1
So its month number is 2
FEB is earlier in the year than JUN

C:\Java>
```

**Figure 9-20** Two typical executions of the EnumDemo application

In the application in Figure 9-19, a `Month` enumeration is declared; in the `main()` method, a `Month` variable is declared in the first shaded statement. The second shaded statement uses the enhanced for loop, which you first learned to use with arrays in Chapter 8. The enhanced for loop declares a local `Month` variable named `mon` that takes on the value of each element in the `Month.value()` array in turn so it can be displayed.

In the program in Figure 9-19, the user then is prompted to enter the first three letters for a month, which are converted to their uppercase equivalents. The third shaded statement in the figure uses the `valueOf()` method to convert the user's string to an enumeration value. The fourth shaded statement gets the position of the month in the enumeration list. The last shaded statement compares the entered month to the `JUN` constant. This is followed by an `if` statement that displays whether the user's entered month comes before or after `JUN` in the list, or is equivalent to it.

Starting with Java 7, you can use comparison operators with enumeration constants instead of using the `compareTo()` method to return a number. For example, you can write the following:

```
if(birthMonth < Month.JUN)
    System.out.println(birthMonth +
        " is earlier in the year than " + Month.JUN);
```

You can use enumerations to control a switch structure. Figure 9-21 contains a class that declares a `Property` enumeration for a real estate company. The program assigns one of the values to a `Property` variable and then uses a switch structure to display an appropriate message. Figure 9-22 shows the result.

```
import java.util.Scanner;
public class EnumDemo2
{
    enum Property {SINGLE_FAMILY, MULTIPLE_FAMILY,
        CONDOMINIUM, LAND, BUSINESS};
    public static void main(String[] args)
    {
        Property propForSale = Property.MULTIPLE_FAMILY;
        switch(propForSale)
        {
            case SINGLE_FAMILY:
            case MULTIPLE_FAMILY:
                System.out.println("Listing fee is 5%");
                break;
            case CONDOMINIUM:
                System.out.println("Listing fee is 6%");
                break;
            case LAND:
            case BUSINESS:
                System.out.println
                    ("We do not handle this type of property");
        }
    }
}
```

Figure 9-21 The EnumDemo2 class

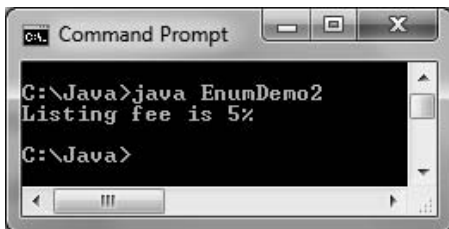


Figure 9-22 Output of the EnumDemo2 application

Creating an enumeration type provides you with several advantages:

- If you did not create an enumerated type for month values, you could use another type—for example, ints or Strings. The problem is that any value could be assigned to an int or String variable, but only the 12 allowed values can be assigned to a Month.
- If you did not create an enumerated type for month values, you could create another type to represent months, but invalid behavior could be applied to the values. For example, you could add or subtract two months, which is not logical. Programmers say using **enums** makes the values type-safe. **Type-safe** describes a data type for which only appropriate behaviors are allowed.

- The `enum` constants provide a form of self-documentation. Someone reading your program might misinterpret what `9` means as a month value, but there is less confusion when you use the identifier `OCT`.
- As with other classes, you can also add methods and other fields to an `enum` type.



Watch the video *Enumerations*.

## TWO TRUTHS & A LIE

### Creating Enumerations

Assume you have coded the following:

```
enum Color {RED, WHITE, BLUE};
Color myColor = Color.RED;
```

1. The value of `myColor.ordinal()` is 1.
2. The value of `myColor.compareTo(Color.RED)` is 0.
3. The value of `myColor < Color.WHITE` is `true`.

The false statement is #1. As the first `enum` constant, the value of `myColor.ordinal()` is 0.

## You Do It

### Using a Two-Dimensional Array:

In this section, you will create an application that demonstrates using a two-dimensional array.

#### To demonstrate a two-dimensional array:

1. Open a new file in your text editor, and start a class that will demonstrate a working two-dimensional array:

```
import java.util.Scanner;
class TwoDimensionalArrayDemo
{
    public static void main(String[] args)
    {
```

2. Declare a three-by-three array of integers. By default, the elements will all be initialized to 0.

```
int[][] count = new int[3][3];
```

3. Declare a `Scanner` object for input, variables to hold a row and column, and a constant that can be used to indicate when the user wants to quit the application.

```
Scanner input = new Scanner(System.in);
int row, column;
final int QUIT = 99;
```

4. Prompt the user to enter a row or the `QUIT` value to quit, then accept the user's input.

```
System.out.print("Enter a row or " + QUIT +
    " to quit > ");
row = input.nextInt();
```

5. In a loop that continues if the user has not entered the `QUIT` value, prompt the user for a column. If the row and column are both within appropriate ranges, add 1 to the element in the selected position.

```
while(row != QUIT)
{
    System.out.print("Enter a column > ");
    column = input.nextInt();
    if(row < count.length && column < count[row].length)
    {
        count[row][column]++;
    }
}
```

6. Still within the `if` statement that checks for a valid row and column, add a nested loop that displays each row and column of the newly incremented array. The elements in each row are displayed on the same line, and a new line is started at the end of each row. Add a closing curly brace for the `if` statement.

```
for(int r = 0; r < count.length; ++r)
{
    for(int c = 0; c < count[r].length; ++c)
        System.out.print(count[r][c] + " ");
    System.out.println();
}
}
```

7. Add an `else` clause to the `if` statement to display an error message when the row or column value is too high.

```
else
    System.out.println("Invalid position selected");
```

8. At the end of the loop, prompt the user for and accept the next row number. Add closing curly braces for the loop, the `main()` method, and the class.

```
System.out.print("Enter a row or " + QUIT +
    " to quit > ");
row = input.nextInt();
}
}
}
```

9. Save the file as **TwoDimensionalArrayDemo.java**. Compile and execute the program. Figure 9-23 shows a typical execution. As the user continues to enter row and column values, the appropriate elements in the array are incremented.

```

C:\Java>java TwoDimensionalArrayDemo
Enter a row or 99 to quit > 0
Enter a column > 0
1 0 0
0 0 0
0 0 0
Enter a row or 99 to quit > 2
Enter a column > 1
1 0 0
0 0 0
0 1 0
Enter a row or 99 to quit > 0
Enter a column > 0
2 0 0
0 0 0
0 1 0
Enter a row or 99 to quit > 5
Enter a column > 5
Invalid position selected
Enter a row or 99 to quit > 99
C:\Java>_

```

**Figure 9-23** Typical execution of the `TwoDimensionalArrayDemo` program

## Using Arrays Class Methods

In this section, you will create an application that demonstrates several `Arrays` class methods. The application will allow the user to enter a menu of entrees that are available for the day at a restaurant. Then, the application will present the menu to the user, allow a request, and indicate whether the requested item is on the menu.

### To write an application that uses `Arrays` class methods:

1. Open a new file in your text editor, and type the `import` statements you need to create an application that will use the `JOptionPane` and the `Arrays` classes:

```
import java.util.*;
import javax.swing.*;
```

2. Add the first few lines of the `MenuSearch` application class:

```
public class MenuSearch
{
    public static void main(String[] args)
    {
```

3. Declare an array to hold the day's menu choices; the user is allowed to enter up to 10 entrees. Also declare two `Strings`—one to hold the user's current entry and the other to accumulate the entire menu list as it is entered. The two `String` variables are initialized to empty `Strings` using quotation marks; if you do not initialize these `Strings`, you receive a compiler error because you might attempt to display them

without having entered a legitimate value. Also, declare an integer to use as a subscript for the array, another to hold the number of menu items entered, and a third to hold the highest allowable subscript, which is 1 less than the array size:

```
String[] menuChoices = new String[10];
String entry = "", menuString = "";
int x = 0;
int numEntered;
int highestSub = menuChoices.length - 1;
```

4. Use the `Arrays.fill()` method to fill the menu array with `z` characters, as shown in the following line of code. You use this method so that when you perform a search later, actual values will be stored in any unused menu positions. If you ignore this step and fill less than half the array, your search method might generate an error.

```
Arrays.fill(menuChoices, "zzzzzz");
```

Lowercase `zs` were purposely chosen as the array fill characters because they have a higher value than any other letter. Therefore, when the user's entries are sorted, the `zzzzzzz` entries will be at the bottom of the list.

5. Display an input dialog box into which the user can enter a menu item. Allow the user to quit before entering 10 items by typing "zzz". (Using a value such as "zzz" is a common programming technique to check for the user's desire to stop entering data. If the data items are numeric instead of text, you might use a value such as 999. Values the user enters that are not "real" data, but just signals to stop, are often called **dummy values**.) After the user enters the first menu item, the application enters a loop that continues to add the entered item to the menu list, increase the subscript, and prompt for a new menu item. The loop continues while the user has not entered "zzz" and the subscript has not exceeded the allowable limit. When the loop ends, save the number of menu items entered:

```
menuChoices[x] = JOptionPane.showInputDialog(null,
    "Enter an item for today's menu, or zzz to quit:");
while(!menuChoices[x].equals("zzz") && x < highestSub)
{
    menuString = menuString + menuChoices[x] + "\n";
    ++x;
    if(x < highestSub)
        menuChoices[x] = JOptionPane.showInputDialog(null,
            "Enter an item for today's menu, or zzz to quit");
}
numEntered = x;
```

6. When the menu is complete, display it for the user and allow the user to make a request:

```
entry = JOptionPane.showInputDialog(null,
    "Today's menu is:\n" + menuString +
    "Please make a selection:");
```

7. Sort the array from index position 0 to `numEntered` so that it is in ascending order prior to using the `binarySearch()` method. If you do not sort the array, the result

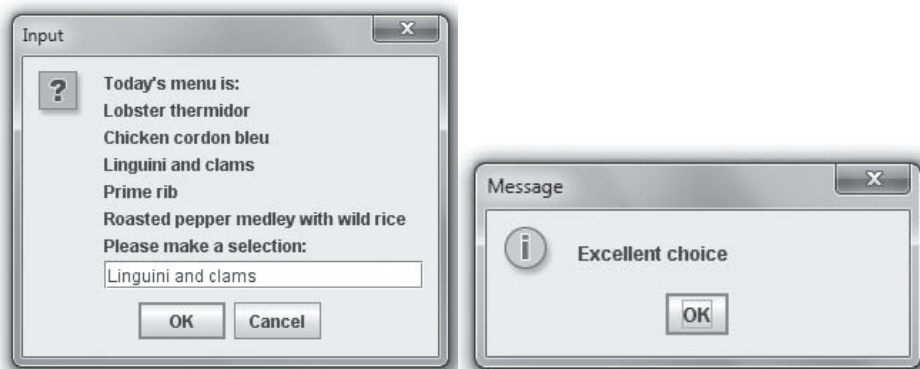
of the `binarySearch()` method is unpredictable. You could sort the entire array, but it is more efficient to sort only the elements that hold actual menu items:

```
Arrays.sort(menuChoices, 0, numEntered);
```

- Use the `Arrays.binarySearch()` method to search for the requested entry in the previously sorted array. If the method returns a nonnegative value that is less than the `numEntered` value, display the message “Excellent choice”; otherwise, display an error message:

```
x = Arrays.binarySearch(menuChoices, entry);  
if(x >= 0 && x < numEntered)  
    JOptionPane.showMessageDialog(null, "Excellent choice");  
else  
    JOptionPane.showMessageDialog(null,  
        "Sorry - that item is not on tonight's menu");
```

- Add the closing curly braces for the `main()` method and the class, and save the file as **MenuSearch.java**. Compile and execute the application. When prompted, enter as many menu choices as you want, and enter “zzz” when you want to quit data entry. When prompted again, enter a menu choice and observe the results. (A choice you enter must match the spelling in the menu exactly.) Figure 9-24 shows a typical menu as it is presented to the user, and the results after the user makes a valid choice.



**Figure 9-24** Typical execution of the MenuSearch application

## Creating Enumerations

In this section, you will create two enumerations that hold colors and car model types. You will use them as field types in a `Car` class and write a demonstration program that shows how the enumerations are used.

### To create `Color` and `Model` enumerations:

- Open a new file in your text editor, and type the following `Color` enumeration:  

```
enum Color {BLACK, BLUE, GREEN, RED, WHITE, YELLOW};
```

2. Save the file as **Color.java**.
3. Open a new file in your text editor, and create the following `Model` enumeration:  

```
enum Model {SEDAN, CONVERTIBLE, MINIVAN};
```

4. Save the file as **Model.java**. Next, open a new file in your text editor, and start to define a `Car` class that holds three fields: a year, a model, and a color.

```
public class Car
{
    private int year;
    private Model model;
    private Color color;
}
```

5. Add a constructor for the `Car` class that accepts parameters that hold the values for year, model, and color as follows:

```
public Car(int yr, Model m, Color c)
{
    year = yr;
    model = m;
    color = c;
}
```

6. Add a `display()` method that displays a `Car` object's data, then add a closing curly brace for the class.

```
public void display()
{
    System.out.println("Car is a " + year +
        " " + color + " " + model);
}
}
```

7. Save the file as **Car.java**.
8. Open a new file in your text editor, and write a short demonstration program that instantiates two `Car` objects and assigns values to them using enumeration values for the models and colors.

```
public class CarDemo
{
    public static void main(String[] args)
    {
        Car firstCar = new Car(2009, Model.MINIVAN, Color.BLUE);
        Car secondCar = new Car(2011, Model.CONVERTIBLE,
            Color.RED);
        firstCar.display();
        secondCar.display();
    }
}
```



9. Save the file as **CarDemo.java**, and then compile and execute it. Figure 9-25 shows that the values are assigned correctly.



```
C:\Java>java CarDemo
Car is a 2009 BLUE MINIVAN
Car is a 2011 RED CONVERTIBLE
C:\Java>_
```

**Figure 9-25** Output of the CarDemo program

## Don't Do It

- Don't forget that the first subscript used with a two-dimensional array represents the row, and that the second subscript represents the column.
- Don't try to store primitive data types in an ArrayList structure.
- Don't think enum constants are strings; they are not enclosed in quotes.

## Key Terms

**Sorting** is the process of arranging a series of objects in some logical order.

When you place objects in order, beginning with the object that has the lowest value, you are sorting in **ascending** order.

When you place objects in order, beginning with the object that has the highest value, you are sorting in **descending** order.

A **bubble sort** is a type of sort in which you continue to compare pairs of items, swapping them if they are out of order, so that the smallest items “bubble” to the top of the list, eventually creating a sorted list.

A **one-dimensional array** or **single-dimensional array** contains one column of values; you access its elements using a single subscript.

**Two-dimensional arrays** have two or more columns of values, and you must use two subscripts to access an element.

When mathematicians use a two-dimensional array, they often call it a **matrix** or a **table**.

A **ragged array** is a two-dimensional array that has rows of different lengths.

**Multidimensional arrays** contain two or more dimensions.

The Java **Arrays class** is a built-in class that contains many useful methods for manipulating arrays, such as methods to search, fill, compare, and sort arrays.

The **ArrayList class** provides a dynamically resizable container that stores lists of objects.

**Dynamically resizable** describes an object whose size can change during program execution.

An **ArrayList's capacity** is the number of items it can hold without having to increase its size.

An **enumerated data type** is a programmer-created data type with a fixed set of values.

The **enum constants** are the allowed values for an enumerated data type.

**Type-safe** describes a data type for which only appropriate behaviors are allowed.

**Dummy values** are values the user enters that are not “real” data, but just signals to stop data entry.

## Chapter Summary

- Sorting is the process of arranging a series of objects in some logical order. When you place objects in order, beginning with the object that has the lowest value, you are sorting in ascending order; conversely, when you start with the object that has the largest value, you are sorting in descending order. A bubble sort is a type of sort in which you continue to compare pairs of items, swapping them if they are out of order, so that the smallest items “bubble” to the top of the list, eventually creating a sorted list.
- You can sort arrays of objects in much the same way that you sort arrays of primitive types. The major difference occurs when you make the comparison that determines whether you want to swap two array elements. When array elements are objects, you usually want to sort based on a particular object field.
- An array that you can picture as a column of values, and whose elements you can access using a single subscript, is a one-dimensional or single-dimensional array. Two-dimensional arrays have both rows and columns. You must use two subscripts when you access an element in a two-dimensional array. When you declare a one-dimensional array, you type a set of square brackets after the array type. To declare a two-dimensional array, you type two sets of brackets after the array type.
- The Java `Arrays` class contains many useful methods for manipulating arrays. These methods provide ways to easily search, compare, fill, and sort arrays.
- The Java `ArrayList` class contains useful methods for manipulating dynamically sized arrays. You can add objects to, remove objects from, and replace objects in `ArrayList` containers.
- A programmer-created data type with a fixed set of values is an enumerated data type. In Java, you create an enumerated data type in a statement that uses the keyword `enum`, an identifier for the type, and a pair of curly braces that contain a list of the `enum` constants, which are the allowed values for the type.

## Review Questions

- When you place objects in order beginning with the object with the highest value, you are sorting in \_\_\_\_\_ order.
  - acquiescing
  - ascending
  - demeaning
  - descending
- Using a bubble sort involves \_\_\_\_\_.
  - comparing parallel arrays
  - comparing each array element to the average
  - comparing each array element to the adjacent array element
  - swapping every array element with its adjacent element
- When you use a bubble sort to perform an ascending sort, after the first pass through an array the largest value is \_\_\_\_\_.
  - at the beginning of the list
  - in the middle of the list
  - at the end of the list
  - It is impossible to determine the answer without more information.
- When you use a bubble sort to perform an ascending sort, after the first pass through an array the smallest value is \_\_\_\_\_.
  - at the beginning of the list
  - in the middle of the list
  - at the end of the list
  - It is impossible to determine the answer without more information.
- When array elements are objects, you usually want to sort based on a particular \_\_\_\_\_ of the object.
  - field
  - method
  - name
  - type
- The following defines a \_\_\_\_\_ array:  

```
int[][]nums = {{1, 2}, {3, 4}, {5, 6}};
```

  - one-dimensional
  - two-dimensional
  - three-dimensional
  - six-dimensional
- How many rows are contained in the following array?  

```
double[][] prices = {{2.56, 3.57, 4.58, 5.59},  
                    {12.35, 13.35, 14.35, 15.00}};
```

  - 1
  - 2
  - 4
  - 8

8. How many columns are contained in the following array?

```
double[][] prices = {{2.56, 3.57, 4.58, 5.59},
                    {12.35, 13.35, 14.35, 15.00}};
```

- a. 1  
b. 2  
c. 4  
d. 8
9. In the following array, what is the value of `code[2][1]`?

```
char[][] code = {{ 'A ', 'D ', 'M '},
                { 'P ', 'R ', 'S '};
                { 'U ', 'V ', 'Z '}};
```

- a. 'P'  
b. 'R'  
c. 'U'  
d. 'V'
10. In the following array, what is the value of `address[1][1]`?

```
String address = {{ "123 Oak ", "345 Elm "};
                 { "87 Maple ", "901 Linden "}};
```

- a. "123 Oak "  
b. "345 Elm "  
c. "87 Maple "  
d. "901 Linden "
11. In the following array, what is the value of `fees.length`?

```
double[][] fees = {{3.00, 3.50, 4.00, 5.00},
                  {6.35, 7.35, 8.35, 9.00}};
```

- a. 2  
b. 4  
c. 8  
d. none of the above
12. In the following array, what is the value of `fees[1].length`?

```
double[][] fees = {{3.00, 3.50, 4.00, 5.00},
                  {6.35, 7.35, 8.35, 9.00}};
```

- a. 2  
b. 4  
c. 8  
d. none of the above
13. You place \_\_\_\_ after the data type in the parameter list of a method that receives a two-dimensional array.

- a. a pair of empty brackets  
b. two pairs of empty brackets  
c. a pair of brackets that contain the number of rows followed by a pair of empty brackets  
d. a pair of empty brackets followed by brackets that contain the number of columns

14. A \_\_\_\_ array has rows of different lengths.
- a. ragged
  - b. jagged
  - c. haggard
  - d. tattered
15. If the value of `credits[0].length` is not equal to `credits[1].length`, you know `credits` is \_\_\_\_.
- a. a three-dimensional array
  - b. an uninitialized array
  - c. a partially populated array
  - d. a ragged array
16. Which of the following is true if a successfully running program contains the following statement:
- ```
Arrays.fill(tax, 10);
```
- a. `tax` is a two-dimensional array.
  - b. `fill()` is a nonstatic method.
  - c. `tax` is an array with 10 elements.
  - d. none of the above
17. Which of the following is a requirement when you use a binary search method with an array?
- a. The array must be numeric.
  - b. The array must have been sorted in ascending order.
  - c. The array must have at least three elements.
  - d. none of the above
18. The chief advantage to using the `ArrayList` class instead of the `Arrays` class is that an `ArrayList` \_\_\_\_.
- a. can be much larger
  - b. is easier to search
  - c. is dynamically resizable
  - d. can be used as an argument to a static method
19. The chief disadvantage to using the `ArrayList` class instead of the `Arrays` class is that an `ArrayList` \_\_\_\_.
- a. cannot be sorted
  - b. cannot store primitive data types
  - c. cannot be accessed using subscripts
  - d. All of the above are disadvantages to using an `ArrayList`.
20. An advantage to using an enumerated data type is \_\_\_\_.
- a. errors are reduced because only a limited set of values can be used with the type
  - b. time is saved because programs with enumerated types compile faster
  - c. coding time is reduced because enumerated types are created automatically by the compiler
  - d. All of the above are true.

## Exercises

1.
  - a. The median of a list is its middle value when the values are placed in order. For example, if a list contains 1, 4, 7, 8, and 9, then the median is 7. Write an application that allows you to enter nine `double` values and display them and their median. Save the file as **Median.java**.
  - b. Revise the `Median` class so that the user can enter any number of values up to nine. If the list has an even number of values, the median is the numeric average of the values in the two middle positions. Save the file as **Median2.java**.
2.
  - a. Write an application containing an array of 15 `double` values. Include a method to sort and display the values in ascending order. Compile, run, and check the results. Save the file as **SortDoubles.java**.
  - b. Modify the `SortDoubles` application to prompt the user whether to view the list in ascending or descending order. Save the file as **SortDoublesWithOptions.java**.
3.
  - a. Create a class named `LibraryBook` that contains fields to hold methods for setting and getting a `LibraryBook`'s title, author, and page count. Save the file as **LibraryBook.java**.
  - b. Write an application that instantiates five `LibraryBook` objects and prompts the user for values for the data fields. Then prompt the user to enter which field the `LibraryBooks` should be sorted by—title, author, or page count. Perform the requested sort procedure, and display the `LibraryBook` objects. Save the file as **LibraryBookSort.java**.
4. Write an application that stores at least four different course names and meeting days and times in a two-dimensional array. Allow the user to enter a course name (such as “CIS 110”) and display the day of the week and time that the course is held (such as “Th 3:30”). If the course does not exist, display an error message. Save the file as **Schedule.java**.
5.
  - a. Table 9-6 shows the various services offered by a hair salon, including its prices and times required:

Service Description	Price (\$)	Time (Minutes)
Cut	8.00	15
Shampoo	4.00	10
Manicure	18.00	30
Style	48.00	55
Permanent	18.00	35
Trim	6.00	5

**Table 9-6** Salon services, prices, and times

- Create a class that holds the service description, price, and the number of minutes it takes to perform the service. Include a constructor that requires arguments for all three data fields and three get methods that each return one of the data field's values. Save the class as **Service.java**.
- b. Write an application named **SalonReport** that contains an array to hold six **Service** objects, and fill it with the data from Table 9-6. Include methods to sort the array in ascending order by each of the data fields. Prompt the user for the preferred sort order, and display the list of services in the requested order. Save the program as **SalonReport.java**.
  6. Create an application that contains an enumeration that represents the days of the week. Display a list of the days, then prompt the user for a day. Display business hours for the chosen day. Assume that the business is open from 11 to 5 on Sunday, 9 to 9 on weekdays, and 9 to 6 on Saturday. Save the file as **DayOfWeek.java**.
  7. Create a class named **Majors** that includes an enumeration for the six majors offered by a college as follows: ACC, CHEM, CIS, ENG, HIS, PHYS. Display the enumeration values for the user, then prompt the user to enter a major. Display the college division in which the major falls. ACC and CIS are in the Business Division, CHEM and PHYS are in the Science Division, and ENG and HIS are in the Humanities Division. Save the file as **Majors.java**.



## Debugging Exercise

8. Each of the following files in the Chapter.09 folder in your downloadable student files has syntax and/or logic errors. In each case, determine the problem and fix the program. After you correct the errors, save each file using the same filename preceded with Fix. For example, `DebugNine1.java` will become `FixDebugNine1.java`.
  - a. `DebugNine1.java`
  - b. `DebugNine2.java`
  - c. `DebugNine3.java`
  - d. `DebugNine4.java`

The folder also contains a `Movie.java` file that is used by `DebugNine2.java`.



## Game Zone

9. Create a guessing game called “Does It Have Legs?”, in which you think of an animal and the computer tries to guess what it is. The game continually becomes “smarter” as you play because you teach it how to become more specific with its questions. For example, a typical game session might proceed as follows:

**Computer:** Does the animal you are thinking of have legs?

**Player:** Yes.

**Computer:** Is it a dog?

**Player:** Yes.

**Computer:** Yay! I win. Do you want to play again?

**Player:** Yes.

**Computer:** Does the animal you are thinking of have legs?

**Player:** Yes.

**Computer:** Is it a dog?

**Player:** No.

**Computer:** I give up. What was your animal?

**Player:** Horse.

**Computer:** Type a question for which the answer is Yes for Dog but No for Horse.

**Player:** Does it live in the house?

**Computer:** Do you want to play again?

**Player:** Yes.

**Computer:** Does the animal you are thinking of have legs?

**Player:** Yes.

**Computer:** Does it live in the house?

**Player:** No.

**Computer:** Is it a Horse?

**Player:** No.

**Computer:** I give up. What was your animal?

**Player:** Cow.

**Computer:** Type a question for which the answer is Yes for Horse but No for Cow.

**Player:** Do people ride it?

**Computer:** Do you want to play again?

**Player:** Yes.

**Computer:** Does the animal you are thinking of have legs?

**Player:** Yes.

**Computer:** Does it live in the house?

**Player:** No.

**Computer:** Do people ride it?

**Player:** No.

**Computer:** Is it a Cow?

**Player:** Yes.

**Computer:** Yay! I win. Do you want to play again?

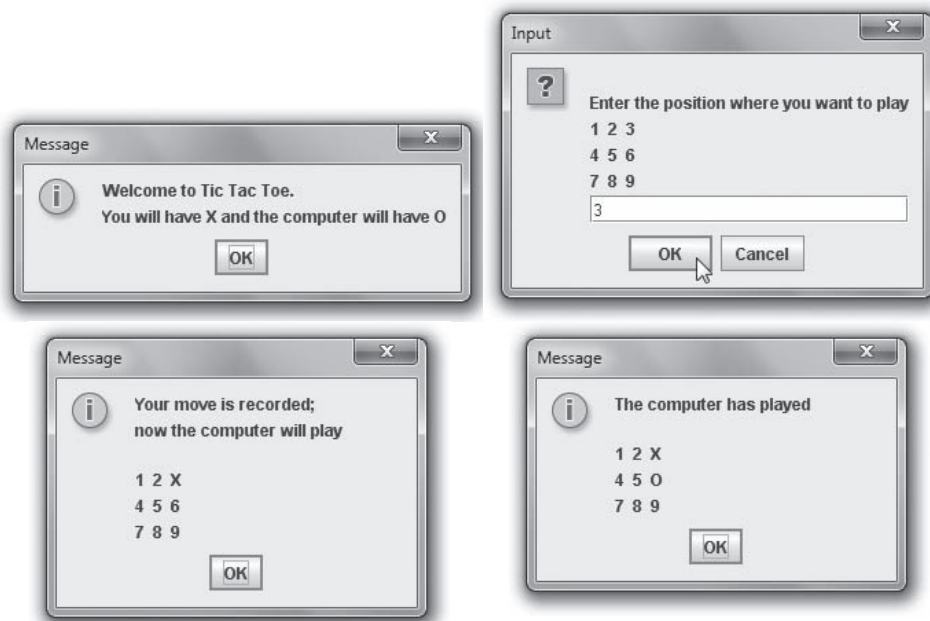
**Player:** No.



(Hint: You might want to look up “binary trees” on the Internet as a method to organize this application.)

Save the application as **DoesItHaveLegs.java**.

10. a. Create a Tic Tac Toe game. In this game, two players alternate placing *X*s and *O*s into a grid until one player has three matching symbols in a row, either horizontally, vertically, or diagonally. Create a game in which the user is presented with a three-by-three grid containing the digits 1 through 9. When the user chooses a position by typing a number, place an *X* in the appropriate spot. Generate a random number for the position where the computer will place an *O*. Do not allow the player or the computer to place a symbol where one has already been placed. Figure 9-26 shows the first four windows in a typical game. When either the player or computer has three symbols in a row, declare a winner; if all positions have been exhausted and no one has three symbols in a row, declare a tie. Save the game as **TicTacToe.java**.



**Figure 9-26** Typical execution of TicTacToe

- b. In the `TicTacToe` application, the computer’s selection is chosen randomly. Improve the `TicTacToe` game so that when the computer has two *O*s in any row, column, or diagonal, it selects the winning position for its next move rather than selecting a position randomly. Save the improved game as **TicTacToe2.java**.

11. In Chapter 8, you created an application class named `FullDeck` that implemented a 52-element array that represented each card in a standard deck of playing cards. Now, create an enumeration that holds the four suits `SPADES`, `HEARTS`, `DIAMONDS`, and `CLUBS`. Save the enumeration in a file named **`Suit.java`**. Modify the `Card` class from previous chapter exercises to use the enumeration, and save the class as **`Card2.java`**. Modify the `FullDeck` application to use the new `Card` class, and save the application as **`FullDeck2.java`**.
12. In Chapter 7, you improved a Rock Paper Scissors game played between a user and the computer. Add an enumeration that holds three values that represent `ROCK`, `PAPER`, and `SCISSORS`, and use it for all comparisons in the program. Save the file as **`RockPaperScissors3.java`**.

# Introduction to Inheritance

In this chapter, you will:

- ① Learn about the concept of inheritance
- ① Extend classes
- ① Override superclass methods
- ① Call constructors during inheritance
- ① Access superclass methods
- ① Employ information hiding
- ① Learn which methods you cannot override

## Learning About the Concept of Inheritance

In Java and all object-oriented languages, **inheritance** is a mechanism that enables one class to inherit, or assume, both the behavior and the attributes of another class. Inheritance is the principle that allows you to apply your knowledge of a general category to more specific objects. A class can inherit all the attributes of an existing class, meaning that you can create a new class simply by indicating the ways in which it differs from an already existing class. You are familiar with the concept of inheritance from all sorts of nonprogramming situations.

When you use the term *inheritance*, you might think of genetic inheritance. You know from biology that your blood type and eye color are the product of inherited genes; you can say that many facts about you—your attributes, or “data fields”—are inherited. Similarly, you often can credit your behavior to inheritance. For example, your attitude toward saving money might be the same as your grandmother’s, and the odd way that you pull on your ear when you are tired might match what your Uncle Steve does—thus, your methods are inherited, too.

You also might choose plants and animals based on inheritance. You plant impatiens next to your house because of your shady street location; you adopt a Doberman pinscher because you need a watchdog. Every individual plant and pet has slightly different characteristics, but within a species, you can count on many consistent inherited attributes and behaviors. Similarly, the classes you create in object-oriented programming languages can inherit data and methods from existing classes. When you create a class by making it inherit from another class, you are provided with data fields and methods automatically.

Beginning with the first chapter of this book, you have been creating classes and instantiating objects that are members of those classes. Programmers and analysts sometimes use a graphical language to describe classes and object-oriented processes; this **Unified Modeling Language (UML)** consists of many types of diagrams. UML diagrams can help illustrate inheritance.

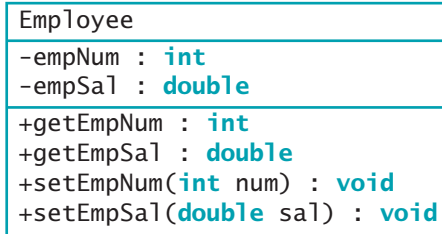
For example, consider the simple `Employee` class shown in Figure 10-1. The class contains two data fields, `empNum` and `empSal`, and four methods, a `get` and `set` method for each field. Figure 10-2 shows a UML class diagram for the `Employee` class. A **class diagram** is a visual tool that provides you with an overview of a class. It consists of a rectangle divided into three sections—the top section contains the name of the class, the middle section contains the names and data types of the attributes, and the bottom section contains the methods. Only the method return type, name, and arguments are provided in the diagram—the instructions that make up the method body are omitted.

```

public class Employee
{
    private int empNum;
    private double empSal;
    public int getEmpNum()
    {
        return empNum;
    }
    public double getEmpSal()
    {
        return empSal;
    }
    public void setEmpNum(int num)
    {
        empNum = num;
    }
    public void setEmpSal(double sal)
    {
        empSal = sal;
    }
}

```

**Figure 10-1** The Employee class



**Figure 10-2** The Employee class diagram



By convention, a class diagram contains the data type following each attribute or method, as shown in Figure 10-2. A minus sign ( - ) is inserted in front of each private field or method, and a plus sign ( + ) is inserted in front of each public field or method.



Commonly, UML diagram creators refrain from using Java terminology such as `int` in a class diagram. Instead, they might use a more general term, such as `integer`. The `Employee` class is designed in natural language (English) and might be implemented in any programming language, and languages other than Java might use a different keyword to designate integer variables. Because you are studying Java, this book uses the Java keywords in diagrams. For more information on UML, you can go to the Object Management Group's Web site at [www.omg.org](http://www.omg.org). OMG is an international, nonprofit computer industry consortium.

After you create the `Employee` class, you can create specific `Employee` objects, such as the following:

```

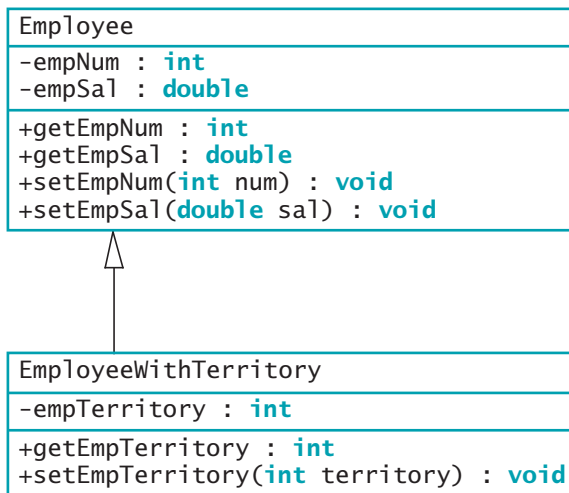
Employee receptionist = new Employee();
Employee deliveryPerson = new Employee();

```

These `Employee` objects can eventually possess different numbers and salaries, but because they are `Employee` objects, you know that each `Employee` has *some* number and salary.

Suppose you hire a new type of `Employee` named `serviceRep`, and that a `serviceRep` object requires not only an employee number and a salary, but also a data field to indicate territory

served. You can create a class with a name such as `EmployeeWithTerritory`, and provide the class three fields (`empNum`, `empSal`, and `empTerritory`) and six methods (get and set methods for each of the three fields). However, when you do this, you are duplicating much of the work that you have already done for the `Employee` class. The wise, efficient alternative is to create the class `EmployeeWithTerritory` so it inherits all the attributes and methods of `Employee`. Then, you can add just the one field and two methods that are new within `EmployeeWithTerritory` objects. Figure 10-3 shows a class diagram of this relationship; the arrow that extends from the `EmployeeWithTerritory` class and points to the `Employee` class shows the inheritance relationship. As Figure 10-3 shows, arrows are used in a UML diagram to show that inheritance relationships extend from the descendant class and point to the one from which it descends.



**Figure 10-3** Class diagram showing the relationship between `Employee` and `EmployeeWithTerritory`

When you use inheritance to create the `EmployeeWithTerritory` class, you:

- Save time because the `Employee` fields and methods already exist
- Reduce errors because the `Employee` methods already have been used and tested
- Reduce the amount of new learning required to use the new class, because you have used the `Employee` methods on simpler objects and already understand how they work

The ability to use inheritance in Java makes programs easier to write, less error prone, and more quickly understood. Besides creating `EmployeeWithTerritory`, you also can create several other specific `Employee` classes (perhaps `EmployeeEarningCommission`, including a

commission rate, or `DismissedEmployee`, including a reason for dismissal). By using inheritance, you can develop each new class correctly and more quickly. The concept of inheritance is useful because it makes class code reusable. Each method already written and tested in the original class becomes part of the new class that inherits it.



In Chapter 4, you learned about the `GregorianCalendar` class. It descends from a more general class named `Calendar`.

## Inheritance Terminology

A class that is used as a basis for inheritance, such as `Employee`, is a **base class**. When you create a class that inherits from a base class (such as `EmployeeWithTerritory`), it is a **derived class**. When considering two classes that inherit from each other, you can tell which is the base class and which is the derived class by using the two classes in a sentence with the phrase “is a(n).” A derived class always “is a” case or example of the more general base class. For example, a `Tree` class can be a base class to an `Evergreen` class. An `Evergreen` “is a” `Tree`, so `Tree` is the base class; however, it is not true for all `Trees` that “a `Tree` is an `Evergreen`.” Similarly, an `EmployeeWithTerritory` “is an” `Employee`—but not the other way around—so `Employee` is the base class.



Because a derived class object “is an” instance of the base class too, you can assign a derived class object’s reference to a base class reference. Similarly, if a method accepts a base class object reference, it will also accept references to its derived classes. The next chapter describes these concepts in greater detail.



Do not confuse “is a” situations with “has a” situations. For example, you might create a `Business` class that contains an array of `Department` objects; in turn, each `Department` object might contain an array of `Employee` objects. You would not say “A department is a business,” but that “a business has departments.” Therefore, this relationship is not inheritance; it is **composition**—the relationship in which a class contains one or more members of another class, when those members would not continue to exist without the object that contains them. (For example, if a `Business` closes, its `Departments` do too.) Similarly, you would not say “an employee is a department,” but that “a department has employees.” This relationship is not inheritance either; it is a specific type of composition known as **aggregation**—the relationship in which a class contains one or more members of another class, when those members would continue to exist without the object that contains them. (For example, if a business or department closed, the employees would continue to exist.)

You can use the terms **superclass** and **subclass** as synonyms for base class and derived class, respectively. Thus, `Evergreen` can be called a subclass of the `Tree` superclass. You can also use the terms **parent class** and **child class**. An `EmployeeWithTerritory` is a child to the `Employee` parent. Use the pair of terms with which you are most comfortable; all of these terms are used interchangeably throughout this book.

As an alternative way to discover which of two classes is the base class or subclass, you can try saying the two class names together. When people say their names together, they state the more specific name before the all-encompassing family name, as in “Ginny Kroening.”

Similarly, with classes, the order that “makes more sense” is the child-parent order. “Evergreen Tree” makes more sense than “Tree Evergreen,” so `Evergreen` is the child class.

Finally, you usually can distinguish superclasses from their subclasses by size. Although it is not required, in general a subclass is larger than a superclass because it usually has additional fields and methods. A subclass description might look small, but any subclass contains all the fields and methods of its superclass, as well as the new, more specific fields and methods you add to that subclass.



Watch the video *Inheritance*.

## TWO TRUTHS & A LIE

### Learning About the Concept of Inheritance

1. When you use inheritance in Java, you can create a new class that contains all the data and methods of an existing class.
2. When you use inheritance, you save time and reduce errors.
3. A class that is used as a basis for inheritance is called a subclass.

The false statement is #3. A class that is used as a basis for inheritance is called a superclass, base class, or parent class. A subclass is a class that inherits from a superclass.

## Extending Classes

You use the keyword **extends** to achieve inheritance in Java. For example, the following class header creates a superclass-subclass relationship between `Employee` and `EmployeeWithTerritory`:

```
public class EmployeeWithTerritory extends Employee
```

Each `EmployeeWithTerritory` automatically receives the data fields and methods of the superclass `Employee`; you then add new fields and methods to the newly created subclass. Figure 10-4 shows an `EmployeeWithTerritory` class.



```
public class EmployeeWithTerritory extends Employee
{
    private int empTerritory;
    public int getEmpTerritory()
    {
        return empTerritory;
    }
    public void setEmpTerritory(int num)
    {
        empTerritory = num;
    }
}
```

**Figure 10-4** The `EmployeeWithTerritory` class

You can write a statement that instantiates a derived class object, such as the following:

```
EmployeeWithTerritory northernRep = new EmployeeWithTerritory();
```

Then you can use any of the next statements to get field values for the `northernRep` object:

```
northernRep.getEmpNum();
northernRep.getEmpSal();
northernRep.getEmpTerritory();
```

The `northernRep` object has access to all three get methods—two methods that it inherits from `Employee` and one method that belongs to `EmployeeWithTerritory`.

Similarly, after the `northernRep` object is declared, any of the following statements are legal:

```
northernRep.setEmpNum(915);
northernRep.setEmpSal(210.00);
northernRep.setEmpTerritory(5);
```

The `northernRep` object has access to all the parent `Employee` class set methods, as well as its own class's new set method.

Inheritance is a one-way proposition; a child inherits from a parent, not the other way around. When you instantiate an `Employee` object, it does not have access to the `EmployeeWithTerritory` methods. It makes sense that a parent class object does not have access to its child's data and methods. When you create the parent class, you do not know how many future subclasses it might have or what their data or methods might look like.

In addition, subclasses are more specific than the superclass they extend. An `Orthodontist` class and `Periodontist` class are children of the `Dentist` parent class. You do not expect all members of the general parent class `Dentist` to have the `Orthodontist`'s `applyBraces()` method or the `Periodontist`'s `deepClean()` method. However, `Orthodontist` objects and `Periodontist` objects have access to the more general `Dentist` methods `conductExam()` and `billPatients()`.

You can use the **instanceof operator** to determine whether an object is a member or descendant of a class. For example, if `northernRep` is an `EmployeeWithTerritory` object, then the value of each of the following expressions is `true`:

```
northernRep instanceof EmployeeWithTerritory  
northernRep instanceof Employee
```

432

If `aClerk` is an `Employee` object, then the following is `true`:

```
aClerk instanceof Employee
```

However, the following is `false`:

```
aClerk instanceof EmployeeWithTerritory
```

Programmers say that `instanceof` yields `true` if the operand on the left can be **upcast** to the operand on the right.

## TWO TRUTHS & A LIE

### Extending Classes

1. You use the keyword `inherits` to achieve inheritance in Java.
2. A derived class has access to all its parents' nonprivate methods.
3. Subclasses are more specific than the superclass they extend.

The false statement is #1. You use the keyword `extends` to achieve inheritance in Java.

## Overriding Superclass Methods

When you create a subclass by extending an existing class, the new subclass contains data and methods that were defined in the original superclass. In other words, any child class object has all the attributes of its parent. Sometimes, however, the superclass data fields and methods are not entirely appropriate for the subclass objects; in these cases, you want to override the parent class members.

When you use the English language, you often use the same method name to indicate diverse meanings. For example, if you think of `MusicalInstrument` as a class, you can think of `play()` as a method of that class. If you think of various subclasses such as `Guitar` and `Drum`, you know that you carry out the `play()` method quite differently for each subclass. Using the same method name to indicate different implementations is called **polymorphism**, a term meaning “many forms”—many different forms of action take place, even though you use the

same word to describe the action. In other words, many forms of the same word exist, depending on the object associated with the word.



You first learned the term *polymorphism* in Chapter 1. Polymorphism is one of the basic principles of object-oriented programming. If a programming language does not support polymorphism, the language is not considered object oriented.

For example, suppose you create an `Employee` superclass containing data fields such as `firstName`, `lastName`, `socialSecurityNumber`, `dateOfHire`, `rateOfPay`, and so on, and the methods contained in the `Employee` class include the usual collection of get and set methods. If your usual time period for payment to each `Employee` object is weekly, your `displayRateOfPay()` method might include a statement such as:

```
System.out.println("Pay is " + rateOfPay + " per week ");
```

Imagine your company has a few `Employees` who are not paid weekly. Maybe some are paid by the hour, and others are `Employees` whose work is contracted on a job-to-job basis. Because each `Employee` type requires different paycheck-calculating procedures, you might want to create subclasses of `Employee`, such as `HourlyEmployee` and `ContractEmployee`.

When you call the `displayRateOfPay()` method for an `HourlyEmployee` object, you want the display to include the phrase “per hour”, as in “Pay is \$8.75 per hour.” When you call the `displayRateOfPay()` method for a `ContractEmployee`, you want to include “per contract”, as in “Pay is \$2000 per contract.” Each class—the `Employee` superclass and the two subclasses—requires its own `displayRateOfPay()` method. Fortunately, if you create separate `displayRateOfPay()` methods for each class, the objects of each class use the appropriate method for that class. When you create a method in a child class that has the same name and parameter list as a method in its parent class, you **override the method** in the parent class. When you use the method name with a child object, the child’s version of the method is used.



It is important to note that each subclass method overrides any method in the parent class that has both the same name and parameter list. If the parent class method has the same name but a different parameter list, the subclass method does not *override* the parent class version; instead, the subclass method *overloads* the parent class method, and any subclass object has access to both versions. You learned about overloading methods in Chapter 4.



You first saw the term *override* in Chapter 4, when you learned that a variable declared within a block overrides another variable with the same name declared outside the block.

If you could not override superclass methods, you could always create a unique name for each subclass method, such as `displayRateOfPayForHourly()`, but the classes you create are easier to write and understand if you use one reasonable name for methods that do essentially the same thing. Because you are attempting to display the rate of pay for each object, `displayRateOfPay()` is a clear and appropriate method name for all the object types.



A child class object can use an overridden parent's method by using the keyword `super`. You will learn about this word later in this chapter.

Object-oriented programmers use the term *polymorphism* when discussing any operation that has multiple meanings. For example, the plus sign ( `+` ) is polymorphic because it operates differently depending on its operands. You can use the plus sign to add integers or `doubles`, to concatenate strings, or to indicate a positive value. As another example, methods with the same name but different parameter lists are polymorphic because the method call operates differently depending on its arguments. When Java developers refer to polymorphism, they most often mean **subtype polymorphism**—the ability of one method name to work appropriately for different subclass objects of the same parent class.



Watch the video *Handling Methods and Inheritance*.

## TWO TRUTHS & A LIE

### Overriding Superclass Methods

1. Any child class object has all the attributes of its parent, but all of those attributes might not be directly accessible.
2. You override a parent class method by creating a child class method with the same identifier but a different parameter list or return type.
3. When a child class method overrides a parent class method, and you use the method name with a child class object, the child class method version executes.

The false statement is #2. You override a parent class method by creating a child class method with the same identifier and parameter list. The return type is not a factor in overloading.

## Calling Constructors During Inheritance

When you create any object, as in the following statement, you are calling a class constructor method that has the same name as the class itself:

```
SomeClass anObject = new SomeClass();
```

When you instantiate an object that is a member of a subclass, you are actually calling at least two constructors: the constructor for the base class and the constructor for the extended, derived class. When you create any subclass object, the superclass constructor must execute first, and *then* the subclass constructor executes.



In the chapter *Advanced Inheritance Concepts*, you will learn that every Java object automatically is a child of a class named `Object`. So, when you instantiate any object, you call its constructor and `Object`'s constructor, and when you create parent and child classes of your own, the child classes use three constructors.

When a superclass contains a default constructor and you instantiate a subclass object, the execution of the superclass constructor often is transparent—that is, nothing calls attention to the fact that the superclass constructor is executing. However, you should realize that when you create an object such as the following (where `HourlyEmployee` is a subclass of `Employee`), *both* the `Employee()` and `HourlyEmployee()` constructors execute.

```
HourlyEmployee clerk = new HourlyEmployee();
```

For example, Figure 10-5 shows three classes. The class named `ASuperClass` has a constructor that displays a message. The class named `ASubClass` descends from `ASuperClass`, and its constructor displays a different message. The `DemoConstructors` class contains just one statement that instantiates one object of type `ASubClass`.

```
public class ASuperClass
{
    public ASuperClass()
    {
        System.out.println("In superclass constructor");
    }
}
public class ASubClass extends ASuperClass
{
    public ASubClass()
    {
        System.out.println("In subclass constructor");
    }
}
public class DemoConstructors
{
    public static void main(String[] args)
    {
        ASubClass child = new ASubClass();
    }
}
```

**Figure 10-5** Three classes that demonstrate constructor calling when a subclass object is instantiated

Figure 10-6 shows the output when `DemoConstructors` executes. You can see that when `DemoConstructors` instantiates the `ASubClass` object, the parent class constructor executes first, displaying its message, and then the child class constructor executes. Even though only one object is created, two constructors execute.

Of course, most constructors perform many more tasks than displaying a message to inform you that they exist. When constructors initialize variables, you usually want the superclass constructor to take care of initializing the data fields that originate in the superclass. Usually, the subclass constructor only needs to initialize the data fields that are specific to the subclass.



```
Command Prompt
C:\Java>java DemoConstructors
In superclass constructor
In subclass constructor
C:\Java>
```

**Figure 10-6** Output of the `DemoConstructors` application

## Using Superclass Constructors That Require Arguments

When you create a class and do not provide a constructor, Java automatically supplies you with a default constructor—one that never requires arguments. When you write your own constructor, you replace the automatically supplied version. Depending on your needs, a constructor you create for a class might be a default constructor or might require arguments. When you use a class as a superclass and the class has only constructors that require arguments, you must be certain that any subclasses provide the superclass constructor with the arguments it needs.



Don't forget that a class can have many constructors. As soon as you create at least one constructor for a class, you can no longer use the automatically supplied version.

When a superclass has a default constructor, you can create a subclass with or without its own constructor. This is true whether the default superclass constructor is the automatically supplied one or one you have written. However, when a superclass contains only constructors that require arguments, you must include at least one constructor for each subclass you create. Your subclass constructors can contain any number of statements, but if all superclass constructors require arguments, then the first statement within each subclass constructor must call one of the superclass constructors. When a superclass requires constructor arguments upon object instantiation, even if you have no other reason to create a subclass constructor, you must write the subclass constructor so it can call its superclass's constructor.

If a superclass has multiple constructors but one is a default constructor, you do not have to create a subclass constructor unless you want to. If the subclass contains no constructor, all subclass objects use the superclass default constructor when they are instantiated.

The format of the statement that calls a superclass constructor from the subclass constructor is:

```
super(list of arguments);
```

The keyword **super** always refers to the superclass of the class in which you use it.

If a superclass contains only constructors that require arguments, you must create a subclass constructor, but the subclass constructor does not necessarily have to have parameters of its own. For example, suppose that you create an `Employee` class with a constructor that requires three arguments—a character, a `double`, and an integer—and you create an `HourlyEmployee` class that is a subclass of `Employee`. The following code shows a valid constructor for `HourlyEmployee`:

```
public HourlyEmployee()
{
    super('P', 12.35, 40);
    // Other statements can go here
}
```

This version of the `HourlyEmployee` constructor requires no arguments, but it passes three constant arguments to its superclass constructor. A different, overloaded version of the `HourlyEmployee` constructor can require arguments. It could then pass the appropriate arguments to the superclass constructor. For example:

```
public HourlyEmployee(char dept, double rate, int hours)
{
    super(dept, rate, hours);
    // Other statements can go here
}
```

Except for any comments, the `super()` statement must be the first statement in any subclass constructor that uses it. Not even data field definitions can precede it. Although it seems that you should be able to use the superclass constructor name to call the superclass constructor—for example, `Employee()`—Java does not allow this. You must use the keyword `super`.



In Chapter 4, you learned that you can call one constructor from another using `this()`. In this chapter, you learned that you can call a base class constructor from a derived class using `super()`. However, you cannot use both `this()` and `super()` in the same constructor because each is required to be the first statement in any constructor in which it appears.



Watch the video *Constructors and Inheritance*.

## TWO TRUTHS & A LIE

### Calling Constructors During Inheritance

1. When you create any subclass object, the subclass constructor executes first, and then the superclass constructor executes.
2. When constructors initialize variables, you usually want the superclass constructor to initialize the data fields that originate in the superclass and the subclass constructor to initialize the data fields that are specific to the subclass.
3. When a superclass contains only nondefault constructors, you must include at least one constructor for each subclass you create.

The false statement is #1. When you create any subclass object, the superclass constructor must execute first, and then the subclass constructor executes.

## Accessing Superclass Methods

Earlier in this chapter, you learned that a subclass can contain a method with the same name and arguments (the same signature) as a method in its parent class. When this happens, using the subclass method overrides the superclass method. However, instead of overriding the superclass method, you might want to use it within a subclass. If so, you can use the keyword `super` to access the parent class method.

For example, examine the `Customer` class in Figure 10-7 and the `PreferredCustomer` class in Figure 10-8. A `Customer` has an `idNumber` and `balanceOwed`. In addition to these fields, a `PreferredCustomer` receives a `discountRate`. In the `PreferredCustomer display()` method, you want to display all three fields—`idNumber`, `balanceOwed`, and `discountRate`. Because two-thirds of the code to accomplish the display has already been written for the `Customer` class, it is convenient to have the `PreferredCustomer display()` method use its parent's version of the `display()` method before displaying its own discount rate. Figure 10-9 shows a brief application that displays one object of each class, and Figure 10-10 shows the output.

```
public class Customer
{
    private int idNumber;
    private double balanceOwed;
    public Customer(int id, double bal)
    {
        idNumber = id;
        balanceOwed = bal;
    }
}
```

Figure 10-7 The `Customer` class (continues)



(continued)

```
public void display()
{
    System.out.println("Customer #" + idNumber +
        " Balance $" + balanceOwed);
}
```

Figure 10-7 The Customer class

```
public class PreferredCustomer extends Customer
{
    double discountRate;
    public PreferredCustomer(int id, double bal, double rate)
    {
        super(id, bal);
        discountRate = rate;
    }
    public void display()
    {
        super.display();
        System.out.println(" Discount rate is " + discountRate);
    }
}
```

Figure 10-8 The PreferredCustomer class



When you call a superclass constructor from a subclass constructor, the call must be the first statement in the constructor. However, when you call an ordinary superclass method within a subclass method, the call is not required to be the first statement in the method.

```
public class TestCustomers
{
    public static void main(String[] args)
    {
        Customer oneCust = new Customer(124, 123.45);
        PreferredCustomer onePCust = new
            PreferredCustomer(125, 3456.78, 0.15);
        oneCust.display();
        onePCust.display();
    }
}
```

Figure 10-9 The TestCustomers application



```
ca. Command Prompt
C:\Java>java TestCustomers
Customer #124 Balance $123.45
Customer #125 Balance $3456.78
Discount rate is 0.15
C:\Java>
```

Figure 10-10 Output of the TestCustomers application

## Comparing `this` and `super`

Within a subclass, you can think of the keyword `this` as the opposite of `super`.

For example, if a subclass has overridden a superclass method named `someMethod()`, then within the subclass, `super.someMethod()` refers to the superclass version of the method, and both `someMethod()` and `this.someMethod()` refer to the subclass version.

On the other hand, when a parent class contains a method that is not overridden within its child, the child can use the method name with `super` (because the method is a member of the superclass), with `this` (because the method is a member of the subclass by virtue of inheritance), or alone (again, because the method is a member of the subclass).

### TWO TRUTHS & A LIE

#### Accessing Superclass Methods

1. You can use the keyword `this` from within a derived class method to access an overridden base class method.
2. You can use the keyword `super` from within a derived class method to access an overridden base class method.
3. You can use the keyword `super` from within a derived class method to access a base class method that has not been overridden.

The false statement is #1. You can use the keyword `super` from within a derived class method to access an overridden base class method; if you use the keyword `this`, then you will access the overriding subclass method.

## Employing Information Hiding

The `Student` class shown in Figure 10-11 is an example of a typical Java class. Within the `Student` class, as with most Java classes, the keyword `private` precedes each data field, and the keyword `public` precedes each method. In fact, the four `get` and `set` methods are `public` within the `Student` class specifically because the data fields are `private`. Without the `public` `get` and `set` methods, there would be no way to access the `private` data fields.

```
public class Student
{
    private int idNum;
    private double gpa;
    public int getIdNum()
    {
        return idNum;
    }
    public double getGpa()
    {
        return gpa;
    }
    public void setIdNum(int num)
    {
        idNum = num;
    }
    public void setGpa(double gradePoint)
    {
        gpa = gradePoint;
    }
}
```

**Figure 10-11** The `Student` class

When an application is a client of the `Student` class (that is, it instantiates a `Student` object), the client cannot directly alter the data in any `private` field. For example, suppose you write a `main()` method that creates a `Student` as:

```
Student someStudent = new Student();
```

Then you cannot change the `Student`'s `idNum` with a statement such as:

```
someStudent.idNum = 812;
```

**Don't Do It**  
You cannot access a `private` data member of an object.

The `idNum` of the `someStudent` object is not accessible in the `main()` method that uses the `Student` object because `idNum` is `private`. Only methods that are part of the `Student` class itself are allowed to alter `private` `Student` data. To alter a `Student`'s `idNum`, you must use a `public` method, as in the following:

```
someStudent.setIdNum(812);
```

The concept of keeping data `private` is known as **information hiding**. When you employ information hiding, your data can be altered only by the methods you choose and only in ways

that you can control. For example, you might want the `setIdNum()` method to check to make certain the `idNum` is within a specific range of values. If a class other than the `Student` class could alter `idNum`, `idNum` could be assigned a value that the `Student` class couldn't control.



You first learned about information hiding and using the `public` and `private` keywords in Chapter 3. You might want to review these concepts.

When a class serves as a superclass to other classes you create, your subclasses inherit all the data and methods of the superclass. The methods in a subclass can use all of the data fields and methods that belong to its parent, with one exception: `private` members of the parent class are not accessible within a child class's methods. If you could use `private` data outside its class, you would lose the advantages of information hiding. For example, if you want the `Student` class data field `idNum` to be `private`, you don't want any outside classes using the field. If a new class could simply extend your `Student` class and get to its data fields without going through the proper channels, information hiding would not be operating.



If the members of a base class don't have an explicit access specifier, their access is `package` by default. Such base class members cannot be accessed within a child class unless the two classes are in the same package. You will learn about packages in the next chapter.

Sometimes, you want to access parent class data from within a subclass. For example, suppose you create two child classes—`PartTimeStudent` and `FullTimeStudent`—that extend the `Student` class. If you want the subclass methods to be able to directly access `idNum` and `gpa`, these data fields cannot be `private`. However, if you don't want other, nonchild classes to access these data fields, they cannot be `public`. To solve this problem, you can create the fields using the specifier `protected`. Using the keyword **`protected`** provides you with an intermediate level of security between `public` and `private` access. If you create a `protected` data field or method, it can be used within its own class or in any classes extended from that class, but it cannot be used by “outside” classes. In other words, `protected` members are those that can be used by a class and its descendants.

You seldom are required to make parent class fields `protected`. A child class can access its parent's `private` data fields by using `public` methods defined in the parent class, just as any other class can. You only need to make parent class fields `protected` if you want child classes to be able to access `private` data directly. (For example, perhaps you do not want a parent class to have a `get` method for a field, but you do want a child class to be able to access the field.) Using the `protected` access specifier for a field can be convenient, and it also improves program performance because a child class can use an inherited field directly instead of “going through” methods to access the data. However, `protected` data members should be used sparingly. Whenever possible, the principle of information hiding should be observed, so even child classes should have to go through `public` methods to “get to” their parent's private data. When child classes are allowed direct access to a parent's fields, the likelihood of future errors increases. Classes that depend on field names from parent classes are said to be **fragile** because they are prone to errors—that is, they are easy to “break.”

**TWO TRUTHS & A LIE****Employing Information Hiding**

1. Information hiding describes the concept of keeping data private.
2. A subclass inherits all the data and methods of its superclass, except the private ones.
3. If a data field is defined as protected, then a method in a child class can use it directly.

The false statement is #2. A subclass inherits all the data and methods of its superclass, but it cannot access the private ones directly.

443

## Methods You Cannot Override

Sometimes when you create a class, you might choose not to allow subclasses to override some of the superclass methods. For example, an `Employee` class might contain a method that calculates each `Employee`'s ID number based on specific `Employee` attributes, and you might not want any derived classes to be able to alter this method. As another example, perhaps a class contains a statement that displays legal restrictions to using the class. You might decide that no derived class should be able to alter the statement that is displayed.

The three types of methods that you cannot override in a subclass are:

- `static` methods
- `final` methods
- Methods within `final` classes

## A Subclass Cannot Override `static` Methods in Its Superclass

A subclass cannot override methods that are declared `static` in the superclass. In other words, a subclass cannot override a class method—a method you use without instantiating an object. A subclass can *hide* a `static` method in the superclass by declaring a `static` method in the subclass with the same signature as the `static` method in the superclass; then, you can call the new `static` method from within the subclass or in another class by using a subclass object. However, this `static` method that hides the superclass `static` method cannot access the parent method using the `super` object.

Figure 10-12 shows a `BaseballPlayer` class that contains a single `static` method named `showOrigins()`. Figure 10-13 shows a `ProfessionalBaseballPlayer` class that extends the `BaseballPlayer` class to provide a salary. Within the `ProfessionalBaseballPlayer` class, an attempt is made to override the `showOrigins()` method to display the general Abner

Doubleday message about baseball as well as the more specific message about professional baseball. However, the compiler returns the error message shown in Figure 10-14—you cannot override a static method with a nonstatic method.

444

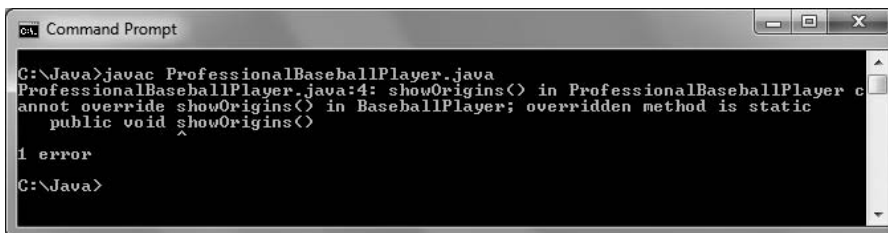
```
public class BaseballPlayer
{
    private int jerseyNumber;
    private double battingAvg;
    public static void showOrigins()
    {
        System.out.println("Abner Doubleday is often " +
            "credited with inventing baseball");
    }
}
```

Figure 10-12 The BaseballPlayer class

```
public class ProfessionalBaseballPlayer extends BaseballPlayer
{
    double salary;
    public void showOrigins() ←
    {
        super.showOrigins();
        System.out.println("The first professional " +
            "major league baseball game was played in 1871");
    }
}
```

**Don't Do It**  
You cannot override  
a static member of  
a parent class.

Figure 10-13 The ProfessionalBaseballPlayer class attempting to override the parent's static method



```
Command Prompt
C:\Java>javac ProfessionalBaseballPlayer.java
ProfessionalBaseballPlayer.java:4: showOrigins() in ProfessionalBaseballPlayer c
annot override showOrigins() in BaseballPlayer; overridden method is static
    public void showOrigins()
           ^
1 error
C:\Java>
```

Figure 10-14 Error message when compiling the ProfessionalBaseballPlayer class in Figure 10-13

Figure 10-15 shows a second version of the `ProfessionalBaseballPlayer` class. In this version, the `showOrigins()` method has been changed to `static`. Figure 10-16 shows the error message that appears, proving that the parent class method is not overridden.

```
public class ProfessionalBaseballPlayer extends BaseballPlayer
{
    double salary;
    public static void showOrigins() ←
    {
        super.showOrigins();
        System.out.println("The first professional " +
            "major league baseball game was played in 1871");
    }
}
```

**Don't Do It**  
You cannot override a static member of a parent class.

**Figure 10-15** The `ProfessionalBaseballPlayer` class attempting to reference `super`

```
Command Prompt
C:\Java>javac ProfessionalBaseballPlayer.java
ProfessionalBaseballPlayer.java:6: non-static variable super cannot be reference
d from a static context
    super.showOrigins();
    ^
1 error
C:\Java>
```

**Figure 10-16** Error message when compiling the `ProfessionalBaseballPlayer` class in Figure 10-15

Finally, Figure 10-17 shows a `ProfessionalBaseballPlayer` class that compiles without error. Its `showOrigins()` method is `static`. Because this method has the same name as the parent class method, when you use the name with a child class object, this method hides the original. However, it does not override the original, or the `super` call in the version of the method in Figure 10-15 would have compiled without error. If you want the `ProfessionalBaseballPlayer` class to display information about baseball in general as well as professional baseball in particular, you can do either of the following:

- You can display both messages from within a child class method with `println()` statements.
- You can use the parent class name, a dot, and the method name. Although a child class cannot inherit its parent's `static` methods, it can access its parent's `static` methods the same way any other class can.

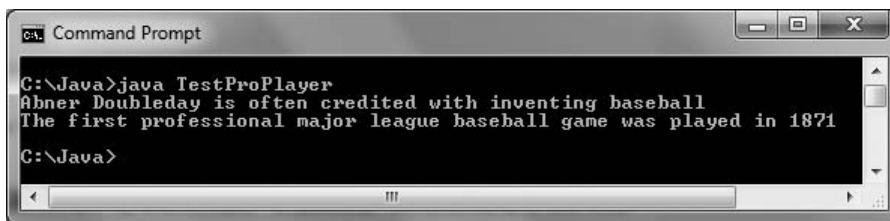
Figure 10-18 shows a class that creates a `ProfessionalBaseballPlayer` and tests the method; Figure 10-19 shows the output.

```
public class ProfessionalBaseballPlayer extends BaseballPlayer
{
    double salary;
    public static void showOrigins()
    {
        BaseballPlayer.showOrigins();
        System.out.println("The first professional " +
            "major league baseball game was played in 1871");
    }
}
```

Figure 10-17 The ProfessionalBaseballPlayer class

```
public class TestProPlayer
{
    public static void main(String[] args)
    {
        ProfessionalBaseballPlayer aYankee =
            new ProfessionalBaseballPlayer();
        aYankee.showOrigins();
    }
}
```

Figure 10-18 The TestProPlayer class



```
Command Prompt
C:\Java>java TestProPlayer
Abner Doubleday is often credited with inventing baseball
The first professional major league baseball game was played in 1871
C:\Java>
```

Figure 10-19 Output of the TestProPlayer application

## A Subclass Cannot Override `final` Methods in Its Superclass

A subclass cannot override methods that are declared `final` in the superclass. For example, consider the `BasketballPlayer` and `ProfessionalBasketballPlayer` classes in Figures 10-20 and 10-21, respectively. When you attempt to compile the `ProfessionalBasketballPlayer` class, you receive the error message in Figure 10-22, because the class cannot override the `final` `displayMessage()` method in the parent class.



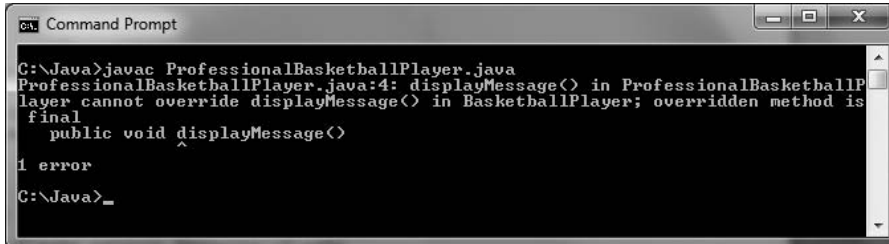
```
public class BasketballPlayer
{
    private int jerseyNumber;
    public final void displayMessage()
    {
        System.out.println("Michael Jordan is the " +
            "greatest basketball player - and that is final");
    }
}
```

Figure 10-20 The BasketballPlayer class

```
public class ProfessionalBasketballPlayer extends BasketballPlayer
{
    double salary;
    public void displayMessage()
    {
        System.out.println("I have nothing to say");
    }
}
```

**Don't Do It**  
A child class method cannot override a final parent class method.

Figure 10-21 The ProfessionalBasketballPlayer class that attempts to override a final method



```
Command Prompt
C:\Java>javac ProfessionalBasketballPlayer.java
ProfessionalBasketballPlayer.java:4: displayMessage() in ProfessionalBasketballP
layer cannot override displayMessage() in BasketballPlayer; overridden method is
final
    public void displayMessage()
           ^
1 error
C:\Java>_
```

Figure 10-22 Error message when compiling the ProfessionalBasketballPlayer class in Figure 10-21



If you make the `displayMessage()` method `final` in the `ProfessionalBasketballPlayer` class in Figure 10-21, you receive the same compiler error message as shown in Figure 10-22. If you make the `displayMessage()` method `static` in the `ProfessionalBasketballPlayer` class, the class does not compile, but you do receive an additional error message.

In Chapter 2, you learned that you can use the keyword `final` when you want to create a constant, as in `final double TAXRATE = 0.065;`. You can also use the `final` modifier with methods when you don't want the method to be overridden—that is, when you want every child class to use the original parent class version of a method.

448

In Java, all instance method calls are **virtual method calls** by default—that is, the method used is determined when the program runs because the type of the object used might not be known until the method executes. For example, with the following method you can pass in a `BasketballPlayer` object, or any object that is a child of `BasketballPlayer`, so the “actual” type of the argument `bbplayer`, and which version of `displayMessage()` to use, is not known until the method executes.

```
public void display(BasketballPlayer bbplayer)
{
    bbplayer.displayMessage();
}
```

In other words, the version of the method used is not determined when the program is compiled; it is determined when the method call is made. Determining the correct method takes a small amount of time. An advantage to making a method `final` is that the compiler knows there will be only one version of the method—the parent class version. Therefore, the compiler *does* know which method version will be used—the only version—and the program is more efficient.

Because a `final` method's definition can never change—that is, can never be overridden with a modified version—the compiler can optimize a program's performance by removing the calls to `final` methods and replacing them with the expanded code of their definitions at each method call location. This process is called **inlining** the code. When a program executes, you are never aware that inlining is taking place; the compiler chooses to use this procedure to save the overhead of calling a method, and the program runs faster. The compiler chooses to inline a `final` method only if it is a small method that contains just one or two lines of code.

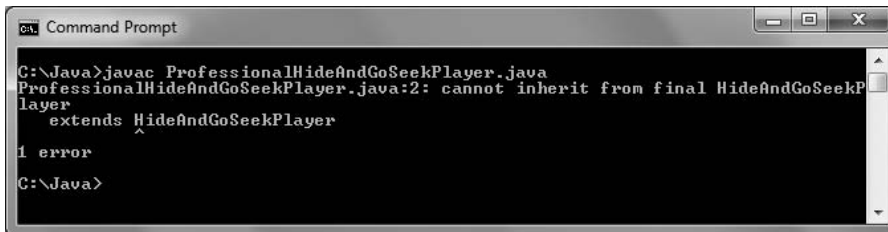
## A Subclass Cannot Override Methods in a `final` Superclass

You can declare a class to be `final`. When you do, all of its methods are `final`, regardless of which access specifier precedes the method name. A `final` class cannot be a parent. Figure 10-23 shows two classes: a `HideAndGoSeekPlayer` class that is a `final` class because of the word `final` in the class header, and a `ProfessionalHideAndGoSeekPlayer` class that attempts to extend the `final` class, adding a salary field. Figure 10-24 shows the error message generated when you try to compile the `ProfessionalHideAndGoSeekPlayer` class.

```
public final class HideAndGoSeekPlayer
{
    private int count;
    public void displayRules()
    {
        System.out.println("You have to count to " + count +
            " before you start looking for hiders");
    }
}
public final class ProfessionalHideAndGoSeekPlayer
    extends HideAndGoSeekPlayer
{
    private double salary;
}
```

**Don't Do It**  
You cannot extend a final class.

**Figure 10-23** The HideAndGoSeekPlayer and ProfessionalHideAndGoSeekPlayer classes



```
ca Command Prompt
C:\Java>javac ProfessionalHideAndGoSeekPlayer.java
ProfessionalHideAndGoSeekPlayer.java:2: cannot inherit from final HideAndGoSeekP
layer
    extends HideAndGoSeekPlayer
    ^
1 error
C:\Java>
```

**Figure 10-24** Error message when compiling the ProfessionalHideAndGoSeekPlayer class in Figure 10-23



Java's `Math` class, which you learned about in Chapter 4, is an example of a `final` class.



A subclass cannot override a method in a `final` class. Conversely, a subclass is *required* to override methods that are declared `abstract` in the superclass (or the subclass itself must be `abstract`). You will learn about `abstract` classes and methods in the next chapter.

## TWO TRUTHS & A LIE

### Methods You Cannot Override

1. A subclass cannot override methods that are declared `static` in the superclass.
2. A subclass cannot override methods that are declared `final` in the superclass.
3. A subclass cannot override methods that are declared `private` in the superclass.

The false statement is #3. A subclass can override private methods as well as public or protected ones.

## You Do It

In this section, you create a working example of inheritance. To see the effects of inheritance, you create this example in four stages:

- First, you create a `Party` class that holds just one data field and two methods.
- After you create the general `Party` class, you write an application to demonstrate its use.
- Then, you create a more specific `DinnerParty` subclass that inherits the attributes of the `Party` class.
- Finally, you modify the demonstration application to add an example using the `DinnerParty` class.

## Creating a Superclass and an Application to Use It

### To create the general `Party` class:

1. Open a new file in your text editor, and enter the following first few lines for a simple `Party` class. The class hosts one integer data field—the number of guests expected at the party:

```
import javax.swing.*;
public class Party
{
    private int guests;
```

2. Add the following method that displays the number of guests:

```
public void displayGuests()
{
    JOptionPane.showMessageDialog(null, "Guests: " + guests);
}
```

3. Add a second method that prompts the user for the number of guests, temporarily stores the response in the `guestsString` field, and then uses the `parseInt()` method to convert the number to an integer to be stored in the class `guests` field:

```
public void inputGuests()
{
    String guestsString = new String(" ");
    guestsString = JOptionPane.showInputDialog(null,
        "Enter the number of guests at your party ");
    guests = Integer.parseInt(guestsString);
}
```

4. Add the closing curly brace for the class, then save the file as **Party.java**. Compile the class, and, if necessary, correct any errors and compile again.

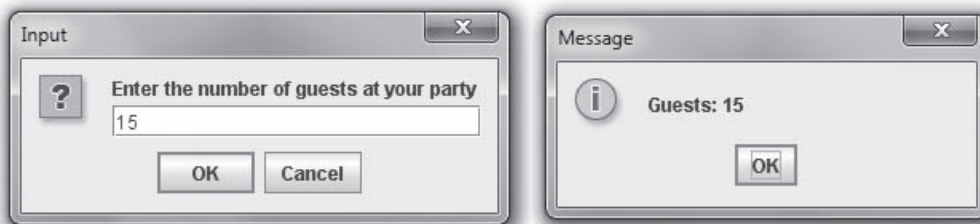
Now that you have created a class, you can use it in an application. A very simple application creates a `Party` object, calls the method to set a value for the data field, and displays the results.

### To write a simple application that uses the `Party` class:

1. Open a new file in your text editor.
2. Write a `UseParty` application that has one method—a `main()` method. Enter the following `main()` method, which declares a `Party` object, supplies it with a value, and then displays the value:

```
public class UseParty
{
    public static void main(String[] args)
    {
        Party aParty = new Party();
        aParty.inputGuests();
        aParty.displayGuests();
    }
}
```

3. Save the file as **UseParty.java**, then compile and run the application. When the program prompts you, enter an integer. Figure 10-25 shows a typical execution. Click **OK** to dismiss the dialog box.



**Figure 10-25** Execution of the `UseParty` application

## Creating a Subclass and an Application to Use It

Next, you create a class named `DinnerParty`. A `DinnerParty` “is a” type of `Party` at which dinner is served, so `DinnerParty` is a child class of `Party`.

### To create a `DinnerParty` class that extends `Party`:

452

1. Open a new file in your text editor, and type the first few lines for the `DinnerParty` class:

```
import javax.swing.*;
public class DinnerParty extends Party
{
```

2. A `DinnerParty` contains a number of guests, but you do not have to define the variable here. The variable is already defined in `Party`, which is the superclass of this class. You only need to add any variables that are particular to a `DinnerParty`. Enter the following code to add an integer to hold the dinner menu choices, which are 1 or 2 for beef or chicken, respectively:

```
private int dinnerChoice;
```

3. Then add constants that represent the dinner choices:

```
final int BEEF_CHOICE = 1;
final int CHICKEN_CHOICE = 2;
```

4. The `Party` class already contains methods to input and display the number of guests, so `DinnerParty` only needs methods to input and display the `dinnerChoice` variable. To keep this example simple, you do not validate the input character to ensure that it is 1 or 2; you can add this improvement to the method later. The `displayDinnerChoice()` method assumes that if the choice is not beef, it must be chicken. Type the `displayDinnerChoice()` method as follows:

```
public void displayDinnerChoice()
{
    if(dinnerChoice == BEEF_CHOICE)
        JOptionPane.showMessageDialog(null,
            "Dinner choice is beef");
    else
        JOptionPane.showMessageDialog(null,
            "Dinner choice is chicken");
}
```

5. Enter the following `inputDinnerChoice()` method, which prompts the user for the choice of entrees at the dinner party. Then add a closing curly brace for the class:

```

public void inputDinnerChoice()
{
    String choice;
    choice = JOptionPane.showInputDialog(null,
        "Enter dinner choice\n" + BEEF_CHOICE + " for beef, " +
        CHICKEN_CHOICE + " for chicken");
    dinnerChoice = Integer.parseInt(choice);
}
}

```

6. Save the file as **DinnerParty.java**, and then compile it.

Now, you can modify the `UseParty` application so that it creates a `DinnerParty` as well as a plain `Party`.

### To modify the `UseParty` application:

1. Open the **UseParty.java** file in your text editor. Change the class name to **UseDinnerParty**.
2. The application uses dialog boxes, so add an `import` line as follows:

```
import javax.swing.*;
```

3. After the statement that constructs the `Party` object, type the following statement so that when you run the application, you identify the creation of the `Party` object:

```
JOptionPane.showMessageDialog(null, "Creating a party");
```

4. After the line that displays the party guest value (just before the closing brace of the program), add the following two new statements. One constructs a `DinnerParty` object, and the other displays a message so that when you run the application you understand you are creating a `DinnerParty`:

```
DinnerParty aDinnerParty = new DinnerParty();
JOptionPane.showMessageDialog(null,
    "Creating a party with dinner");
```

5. Add the following method calls to set the number of guests and dinner choice for the `DinnerParty` object. Even though the `DinnerParty` class does not contain an `inputGuests()` method, its parent class does, so `aDinnerParty` can use the parent class `inputGuests()` method.

```
aDinnerParty.inputGuests();
aDinnerParty.inputDinnerChoice();
```

6. Enter the following code to call the methods that display the entered data:

```
aDinnerParty.displayGuests();
aDinnerParty.displayDinnerChoice();
```

7. Save the file as **UseDinnerParty.java**. Compile the class and run it using values of your choice. Figure 10-26 shows a typical execution. The `DinnerParty` object successfully uses the data field and methods of its superclass, as well as its own data field and methods.

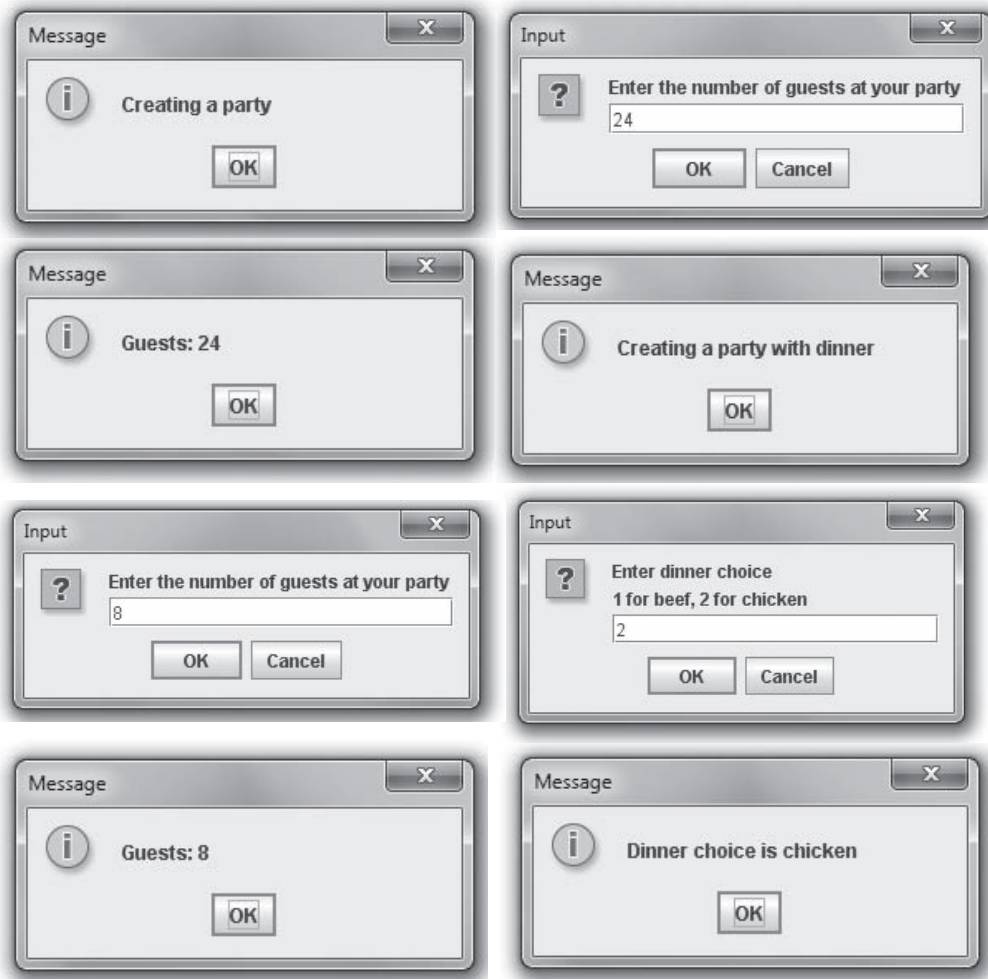


Figure 10-26 Execution of the UseDinnerParty application

## Understanding the Role of Constructors in Inheritance

Next, you add a constructor to the Party class. When you instantiate a subclass object, the superclass constructor executes before the subclass constructor executes.

### To demonstrate that instantiating a subclass object calls the superclass constructor:

1. Open the **Party.java** file in your text editor and save it as **PartyWithConstructor.java**. Be certain to change the class name to **PartyWithConstructor**.
2. Following the statement that declares the **guests** data field, type a constructor that does nothing other than display a message indicating it is working:



```
public PartyWithConstructor()
{
    System.out.println("Creating a Party");
}
```

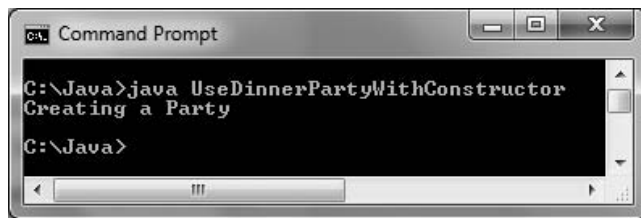
3. Save the file and compile it.
4. In your text editor, open the **DinnerParty.java** file, and change the class header so that both the class name and the parent class name read as follows:

```
public class DinnerPartyWithConstructor extends PartyWithConstructor
```

5. Save the file as **DinnerPartyWithConstructor.java**, and then compile it.
6. In your text editor, open a new file so you can write an application to demonstrate the use of the base class constructor with an extended class object. This application only creates one child class object:

```
public class UseDinnerPartyWithConstructor
{
    public static void main(String[] args)
    {
        DinnerPartyWithConstructor aDinnerParty =
            new DinnerPartyWithConstructor();
    }
}
```

7. Save the application as **UseDinnerPartyWithConstructor.java**, then compile and run it. The output is shown in Figure 10-27. Even though the application only creates one subclass object (and no superclass objects) and the subclass contains no constructor of its own, the superclass constructor executes.



**Figure 10-27** Output of the UseDinnerPartyWithConstructor application

## Inheritance When the Superclass Requires Constructor Arguments

Next, you modify the `PartyWithConstructor` class so that its constructor requires an argument. Then, you will observe that a subclass without a constructor cannot compile.

456

### To demonstrate how inheritance works when a superclass constructor requires an argument:

1. Open the `PartyWithConstructor.java` file in your text editor, and then change the class name to `PartyWithConstructor2`.
2. Replace the existing constructor with a new version that requires an argument, which it uses to set the number of guests who will attend a party:

```
public PartyWithConstructor2(int numGuests)
{
    guests = numGuests;
}
```

3. Save the file as `PartyWithConstructor2.java`, and then compile it.

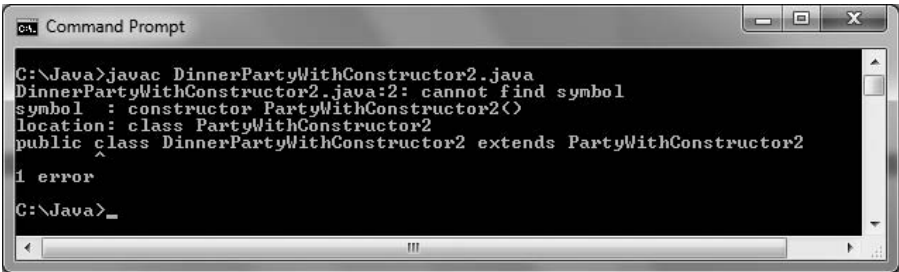
Next, you modify the `DinnerPartyWithConstructor` class so it inherits from `PartyWithConstructor2`.

### To create the child class:

1. Open the `DinnerPartyWithConstructor.java` file in your text editor.
2. Change the class header as follows so that the name of the class is `DinnerPartyWithConstructor2`, and inherits from `PartyWithConstructor2`:

```
public class DinnerPartyWithConstructor2 extends
    PartyWithConstructor2
```

3. Save the file as `DinnerPartyWithConstructor2.java`, and then compile it. An error message appears, as shown in Figure 10-28. When you attempt to compile the subclass, no parameterless constructor can be found in the superclass, so the compile fails.



```
Command Prompt
C:\Java>javac DinnerPartyWithConstructor2.java
DinnerPartyWithConstructor2.java:2: cannot find symbol
symbol  : constructor PartyWithConstructor2()
location: class PartyWithConstructor2
public class DinnerPartyWithConstructor2 extends PartyWithConstructor2
1 error
C:\Java>
```

**Figure 10-28** Error message generated when compiling the `DinnerPartyWithConstructor2` class

### To correct the error:

1. Open the **DinnerPartyWithConstructor2.java** file in your text editor, if it is not still open.
2. Following the variable and constant declarations, insert a constructor for the class as follows:

```
public DinnerPartyWithConstructor2(int numGuests)
{
    super(numGuests);
}
```

3. Save the file and compile it. This time, the compile is successful because the subclass calls its parent's constructor, passing along an integer value. Note that the **DinnerPartyWithConstructor2** subclass constructor is not required to receive an integer argument, although in this example it does. For example, it would be acceptable to create a subclass constructor that required no arguments but passed a constant (for example, 0) to its parent. Similarly, the subclass constructor could require several arguments and pass one of them to its parent. The requirement is not that the subclass constructor must have the same number or types of parameters as its parent; the only requirement is that the subclass constructor calls `super()` and passes to the parent what it needs to execute.

Now, you can create an application to demonstrate creating parent and child class objects when the parent constructor needs an argument.

### To create the application:

1. Open a new file in your text editor, and then enter the following first few lines of an application that demonstrates creating superclass and subclass objects using the classes you just created:

```
public class UsePartiesWithConstructors
{
    public static void main(String[] args)
    {
```

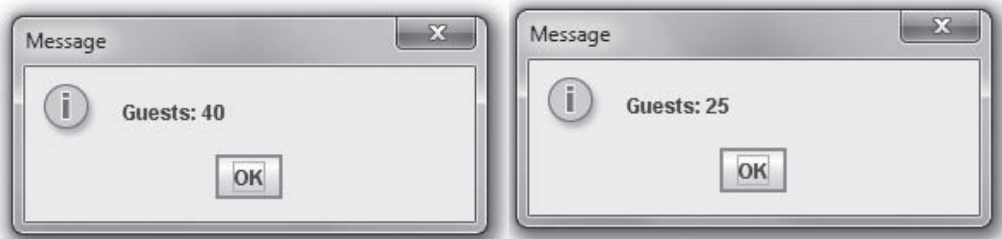
2. Enter the following code to create two objects: a **PartyWithConstructor2** object with 40 guests and a **DinnerPartyWithConstructor2** object with 25 guests.

```
PartyWithConstructor2 aParty = new PartyWithConstructor2(40);
DinnerPartyWithConstructor2 aDinnerParty = new
    DinnerPartyWithConstructor2(25);
```

3. Add the following statements to display guest values for each object, and add closing curly braces for the method and the class:

```
        aParty.displayGuests();
        aDinnerParty.displayGuests();
    }
}
```

4. Save the file as **UsePartiesWithConstructors.java**, and then compile and execute the application. The output appears in Figure 10-29. First, the party guests are displayed, followed by the dinner party guests.



**Figure 10-29** Output of the UsePartiesWithConstructors application

## Don't Do It

- Don't capitalize the *o* in the `instanceof` operator. Although the second word in an identifier frequently is capitalized in Java, `instanceof` is an exception.
- Don't try to directly access private superclass members from a subclass.
- Don't forget to call a superclass constructor from within a subclass constructor if the superclass does not contain a default constructor.

## Key Terms

**Inheritance** is a mechanism that enables one class to inherit, or assume, both the behavior and the attributes of another class.

The **Unified Modeling Language (UML)** is a graphical language used by programmers and analysts to describe classes and object-oriented processes.

A **class diagram** is a visual tool that provides you with an overview of a class. It consists of a rectangle divided into three sections—the top section contains the name of the class, the middle section contains the names and data types of the attributes, and the bottom section contains the methods.

A **base class** is a class that is used as a basis for inheritance.

A **derived class** is a class that inherits from a base class.

**Composition** is the relationship in which one class contains one or more members of another class that would not continue to exist without the object that contains them.

**Aggregation** is a type of composition in which a class contains one or more members of another class that would continue to exist without the object that contains them.

**Superclass** and **subclass** are synonyms for base class and derived class.

**Parent class** and **child class** are synonyms for base class and derived class.

The keyword **extends** is used to achieve inheritance in Java.

The **instanceof operator** determines whether an object that is the operand on the left is a member or descendant of the class that is the operand on the right.

To **upcast** an object is to change it to an object of a class higher in the object's inheritance hierarchy.

**Polymorphism** is the technique of using the same method name to indicate different implementations.

To **override a method** in a parent class is to create a method in a child class that has the same name and parameter list as a method in its parent class.

**Subtype polymorphism** is the ability of one method name to work appropriately for different subclasses of a parent class.

The keyword **super** always refers to the superclass of the class in which you use it.

**Information hiding** is the concept of keeping data private.

The keyword **protected** provides you with an intermediate level of security between `public` and `private` access. Protected members are those that can be used by a class and its descendants.

**Fragile** classes are those that are prone to errors.

**Virtual method calls** are those in which the method used is determined when the program runs, because the type of the object used might not be known until the method executes. In Java, all instance method calls are virtual calls by default.

**Inlining** the code is an automatic process that optimizes performance. Because a `final` method's definition can never be overridden, the compiler can optimize a program's performance by removing the calls to `final` methods and replacing them with the expanded code of their definitions at each method call location.

## Chapter Summary

- In Java, inheritance is a mechanism that enables one class to inherit both the behavior and the attributes of another class. Using inheritance saves time because the original fields and methods already exist, have been tested, and are familiar to users. A class that is used as a basis for inheritance is a base class. A class you create that inherits from a base class is called a derived class. You can use the terms *superclass* and *subclass* as synonyms for base class and derived class; you can also use the terms *parent class* and *child class*.

- You use the keyword `extends` to achieve inheritance in Java. A parent class object does not have access to its child's data and methods, but when you create a subclass by extending an existing class, the new subclass contains data and methods that were defined in the original superclass.
- Sometimes, superclass data fields and methods are not entirely appropriate for the subclass objects. Polymorphism is the act of using the same method name to indicate different implementations. You use polymorphism when you override a superclass method in a subclass by creating a method with the same name and parameter list.
- When you create any subclass object, the superclass constructor must execute first, and *then* the subclass constructor executes. When a superclass contains only constructors that require arguments, you must include at least one constructor for each subclass you create. Your subclass constructors can contain any number of statements, but the first statement within each constructor must call the superclass constructor. When a superclass requires parameters upon instantiation, even if you have no other reason to create a subclass constructor, you must write the subclass constructor so it can call its superclass's constructor. The format of the statement that calls a superclass constructor is `super(list of arguments);`.
- If you want to use a superclass method within a subclass, you can use the keyword `super` to access the parent class method.
- When a class serves as a superclass to other classes you create, the subclasses inherit all the data and methods of the superclass. The methods in a subclass can use all of the data fields and methods that belong to its parent, but `private` members of the parent class are not accessible with a child class's methods. Using the keyword `protected` provides you with an intermediate level of security between `public` and `private` access. If you create a `protected` data field or method, it can be used within its own class or in any classes extended from that class, but it cannot be used by "outside" classes. A subclass cannot override methods that are declared `static` in the superclass. A subclass can *hide* a `static` method in the superclass by declaring a `static` method in the subclass with the same signature as the `static` method in the superclass. A subclass cannot override methods that are declared `final` in the superclass or methods declared within a `final` class.

## Review Questions

1. A way to discover which of two classes is the base class and which is the subclass is to \_\_\_\_\_.
  - a. look at the class size
  - b. try saying the two class names together
  - c. use polymorphism
  - d. Both a and b are correct.

2. Employing inheritance reduces errors because \_\_\_\_\_.
  - a. the new classes have access to fewer data fields
  - b. the new classes have access to fewer methods
  - c. you can copy methods that you already created
  - d. many of the methods you need have already been used and tested
  
3. A base class can also be called a \_\_\_\_\_.
  - a. child class
  - b. subclass
  - c. derived class
  - d. superclass
  
4. Which of the following choices is the best example of a parent class/child class relationship?
  - a. Rose/Flower
  - b. Present/Gift
  - c. Dog/Poodle
  - d. Sparrow/Bird
  
5. The Java keyword that creates inheritance is \_\_\_\_\_.
  - a. `static`
  - b. `enlarge`
  - c. `extends`
  - d. `inherits`
  
6. A class named `Building` has a `public`, nonstatic method named `getFloors()`. If `School` is a child class of `Building`, and `modelHigh` is an object of type `School`, which of the following statements is valid?
  - a. `Building.getFloors();`
  - b. `School.getFloors();`
  - c. `modelHigh.getFloors();`
  - d. All of the previous statements are valid.
  
7. Which of the following statements is true?
  - a. A child class inherits from a parent class.
  - b. A parent class inherits from a child class.
  - c. Both of the preceding statements are true.
  - d. Neither a nor b is true.
  
8. When a subclass method has the same name and argument types as a superclass method, the subclass method \_\_\_\_\_ the superclass method.
  - a. overrides
  - b. overuses
  - c. overloads
  - d. overcompensates
  
9. When you instantiate an object that is a member of a subclass, the \_\_\_\_\_ constructor executes first.
  - a. subclass
  - b. child class
  - c. extended class
  - d. parent class

10. The keyword `super` always refers to the \_\_\_\_\_ of the class in which you use it.
  - a. child class
  - b. derived class
  - c. subclass
  - d. parent class
11. If the only constructor in a superclass requires arguments, its subclass \_\_\_\_\_.
  - a. must contain a constructor
  - b. must not contain a constructor
  - c. must contain a constructor that requires arguments
  - d. must not contain a constructor that requires arguments
12. If a superclass constructor requires arguments, any constructor of its subclasses must call the superclass constructor \_\_\_\_\_.
  - a. as the first statement
  - b. as the last statement
  - c. at some time
  - d. multiple times if multiple arguments are involved
13. A child class `Motorcycle` extends a parent class `Vehicle`. Each class constructor requires one `String` argument. The `Motorcycle` class constructor can call the `Vehicle` class constructor with the statement \_\_\_\_\_.
  - a. `Vehicle("Honda");`
  - b. `Motorcycle("Harley");`
  - c. `super("Suzuki");`
  - d. none of the above
14. In Java, the concept of keeping data private is known as \_\_\_\_\_.
  - a. polymorphism
  - b. information hiding
  - c. data deception
  - d. concealing fields
15. If you create a data field or method that is \_\_\_\_\_, it can be used within its own class or in any classes extended from that class.
  - a. `public`
  - b. `protected`
  - c. `private`
  - d. both a and b
16. Within a subclass, you cannot override \_\_\_\_\_ methods.
  - a. `public`
  - b. `private`
  - c. `static`
  - d. constructor
17. You call a `static` method using \_\_\_\_\_.
  - a. the name of its class, a dot, and the method name
  - b. the name of the class's superclass, a dot, and the method name
  - c. the name of an object in the same class, a dot, and the method name
  - d. either a or b



18. You use a \_\_\_\_\_ method access specifier when you create methods for which you want to prevent overriding in extended classes.
- a. `public`
  - b. `protected`
  - c. `final`
  - d. `subclass`
19. A compiler can decide to \_\_\_\_\_ a `final` method—that is, determine the code of the method call when the program is compiled.
- a. `duplicate`
  - b. `inline`
  - c. `redline`
  - d. `beeline`
20. When a parent class contains a `static` method, child classes \_\_\_\_\_ override it.
- a. frequently
  - b. seldom
  - c. must
  - d. cannot

## Exercises

1. Create a class named `Book` that contains data fields for the title and number of pages. Include get and set methods for these fields. Next, create a subclass named `Textbook`, which contains an additional field that holds a grade level for the `Textbook` and additional methods to get and set the grade level field. Write an application that demonstrates using objects of each class. Save the files as **`Book.java`**, **`Textbook.java`**, and **`DemoBook.java`**.
2. Create a class named `Square` that contains data fields for `height`, `width`, and `surfaceArea`, and a method named `computeSurfaceArea()`. Create a child class named `Cube`. `Cube` contains an additional data field named `depth`, and a `computeSurfaceArea()` method that overrides the parent method. Write an application that instantiates a `Square` object and a `Cube` object and displays the surface areas of the objects. Save the files as **`Cube.java`**, **`Square.java`**, and **`DemoSquare.java`**.
3. Create a class named `Order` that performs order processing of a single item. The class has five fields: customer name, customer number, quantity ordered, unit price, and total price. Include set and get methods for each field except the total price field. The set methods prompt the user for values for each field. This class also needs a method to compute the total price (quantity times unit price) and a method to display the field values. Create a subclass named `ShippedOrder` that overrides `computePrice()` by adding a shipping and handling charge of \$4.00. Write an application named `UseOrder` that instantiates an object of each of these classes. Prompt the user for data for the `Order` object, and display the results; then prompt the user for data for the `ShippedOrder` object, and display the results. Save the files as **`Order.java`**, **`ShippedOrder.java`**, and **`UseOrder.java`**.
4. a. Create a class named `Year` that contains a data field that holds the number of days in a year. Include a get method that displays the number of days and a constructor that sets the number of days to 365. Create a subclass named `LeapYear`. `LeapYear`'s constructor overrides `Year`'s constructor and sets the number of days

- to 366. Write an application named `UseYear` that instantiates one object of each class and displays their data. Save the files as **`Year.java`**, **`LeapYear.java`**, and **`UseYear.java`**.
- b. Add a method named `daysElapsed()` to the `Year` class you created in Exercise 4a. The `daysElapsed()` method accepts two arguments representing a month and a day; it returns an integer indicating the number of days that have elapsed since January 1 of that year. For example, on March 3 in nonleap years, 61 days have elapsed (31 in January, 28 in February, and 2 in March). Create a `daysElapsed()` method for the `LeapYear` class that overrides the method in the `Year` class. For example, on March 3 in a `LeapYear`, 62 days have elapsed (31 in January, 29 in February, and 2 in March). Write an application named `UseYear2` that prompts the user for a month and day, and calculates the days elapsed in a `Year` and in a `LeapYear`. Save the files as **`Year2.java`**, **`LeapYear2.java`**, and **`UseYear2.java`**.
5. Create a class named `HotelRoom` that includes an integer field for the room number and a `double` field for the nightly rental rate. Include get methods for these fields and a constructor that requires an integer argument representing the room number. The constructor sets the room rate based on the room number; rooms numbered 299 and below are \$69.95 per night, and others are \$89.95 per night. Create an extended class named `Suite` whose constructor requires a room number and adds a \$40 surcharge to the regular hotel room rate, which again is based on the room number. Write an application named `UseHotelRoom` that creates an object of each class, and demonstrate that all the methods work correctly. Save the files as **`HotelRoom.java`**, **`Suite.java`**, and **`UseHotelRoom.java`**.
6. Create a class named `Package` with data fields for weight in ounces, shipping method, and shipping cost. The shipping method is a character: 'A' for air, 'T' for truck, or 'M' for mail. The `Package` class contains a constructor that requires arguments for weight and shipping method. The constructor calls a `calculateCost()` method that determines the shipping cost, based on the following table:

Weight (oz.)	Air (\$)	Truck (\$)	Mail (\$)
1 to 8	2.00	1.50	.50
9 to 16	3.00	2.35	1.50
17 and over	4.50	3.25	2.15

The `Package` class also contains a `display()` method that displays the values in all four fields. Create a subclass named `InsuredPackage` that adds an insurance cost to the shipping cost, based on the following table:

Shipping Cost Before Insurance (\$)	Additional Cost (\$)
0 to 1.00	2.45
1.01 to 3.00	3.95
3.01 and over	5.55

Write an application named `UsePackage` that instantiates at least three objects of each type (`Package` and `InsuredPackage`) using a variety of weights and shipping method codes. Display the results for each `Package` and `InsuredPackage`. Save the files as **`Package.java`**, **`InsuredPackage.java`**, and **`UsePackage.java`**.

7. Create a class named `CarRental` that contains fields that hold a renter's name, zip code, size of the car rented, daily rental fee, length of rental in days, and total rental fee. The class contains a constructor that requires all the rental data except the daily rate and total fee, which are calculated based on the size of the car: economy at \$29.99 per day, midsize at \$38.99 per day, or full size at \$43.50 per day. The class also includes a `display()` method that displays all the rental data. Create a subclass named `LuxuryCarRental`. This class sets the rental fee at \$79.99 per day and prompts the user to respond to the option of including a chauffeur at \$200 more per day. Override the parent class `display()` method to include chauffeur fee information. Write an application named `UseCarRental` that prompts the user for the data needed for a rental and creates an object of the correct type. Display the total rental fee. Save the files as **`CarRental.java`**, **`LuxuryCarRental.java`**, and **`UseCarRental.java`**.
8. Create a class named `CollegeCourse` that includes data fields that hold the department (for example, ENG), the course number (for example, 101), the credits (for example, 3), and the fee for the course (for example, \$360). All of the fields are required as arguments to the constructor, except for the fee, which is calculated at \$120 per credit hour. Include a `display()` method that displays the course data. Create a subclass named `LabCourse` that adds \$50 to the course fee. Override the parent class `display()` method to indicate that the course is a lab course and to display all the data. Write an application named `UseCourse` that prompts the user for course information. If the user enters a class in any of the following departments, create a `LabCourse`: BIO, CHM, CIS, or PHY. If the user enters any other department, create a `CollegeCourse` that does not include the lab fee. Then display the course data. Save the files as **`CollegeCourse.java`**, **`LabCourse.java`**, and **`UseCourse.java`**.
9. Create a class named `Vehicle` that acts as a superclass for vehicle types. The `Vehicle` class contains private variables for the number of wheels and the average number of miles per gallon. The `Vehicle` class also contains a constructor with

integer arguments for the number of wheels and average miles per gallon, and a `toString()` method that returns a `String` containing these values. Create two subclasses, `Car` and `MotorCycle`, that extend the `Vehicle` class. Each subclass contains a constructor that accepts the miles-per-gallon value as an argument and forces the number of wheels to the appropriate value—2 for a `MotorCycle` and 4 for a `Car`. Write a `UseVehicle` class to instantiate the two `Vehicle` objects and display the objects' values. Save the files as **Vehicle.java**, **Car.java**, **MotorCycle.java**, and **UseVehicle.java**.

10. Develop a set of classes for a college to use in various student service and personnel applications. Classes you need to design include the following:
  - ♦ **Person**—A `Person` contains a first name, last name, street address, zip code, and phone number. The class also includes a method that sets each data field, using a series of dialog boxes and a display method that displays all of a `Person`'s information on a single line at the command line on the screen.
  - ♦ **CollegeEmployee**—`CollegeEmployee` descends from `Person`. A `CollegeEmployee` also includes a Social Security number, an annual salary, and a department name, as well as methods that override the `Person` methods to accept and display all `CollegeEmployee` data.
  - ♦ **Faculty**—`Faculty` descends from `CollegeEmployee`. This class also includes a Boolean field that indicates whether the `Faculty` member is tenured, as well as methods that override the `CollegeEmployee` methods to accept and display this additional piece of information.
  - ♦ **Student**—`Student` descends from `Person`. In addition to the fields available in `Person`, a `Student` contains a major field of study and a grade point average as well as methods that override the `Person` methods to accept and display these additional facts.

Write an application named `CollegeList` that declares an array of four “regular” `CollegeEmployees`, three `Faculty`, and seven `Students`. Prompt the user to specify which type of person's data will be entered ('C', 'F', or 'S'), or allow the user to quit ('Q'). While the user chooses to continue (that is, does not quit), accept data entry for the appropriate type of `Person`. If the user attempts to enter data for more than four `CollegeEmployees`, three `Faculty`, or seven `Students`, display an error message. When the user quits, display a report on the screen listing each group of `Persons` under the appropriate heading “College Employees,” “Faculty,” or “Students.” If the user has not entered data for one or more types of `Persons` during a session, display an appropriate message under the appropriate heading.

Save the files as **Person.java**, **CollegeEmployee.java**, **Faculty.java**, **Student.java**, and **CollegeList.java**.



## Debugging Exercise

11. Each of the following files in the Chapter.10 folder of your downloadable student files has syntax and/or logic errors. In each case, determine the problem and fix the program. After you correct the errors, save each file using the same filename preceded with Fix. For example, DebugTen1.java will become FixDebugTen1.java.
  - a. DebugTen1.java
  - b. DebugTen2.java
  - c. DebugTen3.java
  - d. DebugTen4.java

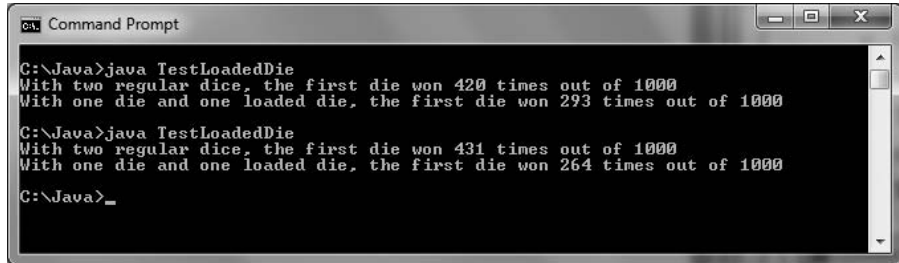
The folder also contains eight other Debug files in the Chapter.10 folder; these files are used by the DebugTen exercises.



## Game Zone

12.
  - a. Create an `Alien` class. Include at least three protected data members of your choice, such as the number of eyes the `Alien` has. Include a constructor that requires a value for each data field and a `toString()` method that returns a `String` containing a complete description of the `Alien`. Save the file as **Alien.java**.
  - b. Create two classes—`Martian` and `Jupiterian`—that descend from `Alien`. Supply each with a constructor that sets the `Alien` data fields with values you choose. For example, you can decide that a `Martian` has four eyes but a `Jupiterian` has only two. Save the files as **Martian.java** and **Jupiterian.java**.
  - c. Create an application that instantiates one `Martian` and one `Jupiterian`. Call the `toString()` method with each object and display the results. Save the application as **CreateAliens.java**.
13.
  - a. In Chapter 4, you created a `Die` class that you can use to instantiate objects that hold one of six randomly selected values. Modify this class so its value field is protected instead of `private`. This will allow a child class to access the value. Save the file as **Die.java**.
  - b. Create a `LoadedDie` class that can be used to give a player a slight advantage over the computer. A `LoadedDie` never rolls a 1; it only rolls values 2 through 6. Save the file as **LoadedDie.java**.

- c. Create a program that rolls two `Die` objects against each other 1,000 times and count the number of times the first `Die` has a higher value than the other `Die`. Then roll a `Die` object against a `LoadedDie` object 1,000 times, and count the number of times the `Die` wins. Display the results. Save the application as **TestLoadedDie.java**. Figure 10-30 shows two typical executions.



```
cmd: Command Prompt
C:\Java>java TestLoadedDie
With two regular dice, the first die won 420 times out of 1000
With one die and one loaded die, the first die won 293 times out of 1000

C:\Java>java TestLoadedDie
With two regular dice, the first die won 431 times out of 1000
With one die and one loaded die, the first die won 264 times out of 1000

C:\Java>_
```

**Figure 10-30** Two typical executions of the `TestLoadedDie` application

# Advanced Inheritance Concepts

In this chapter, you will:

- ⦿ Create and use abstract classes
- ⦿ Use dynamic method binding
- ⦿ Create arrays of subclass objects
- ⦿ Use the `Object` class and its methods
- ⦿ Use inheritance to achieve good software design
- ⦿ Create and use interfaces
- ⦿ Create and use packages

## Creating and Using Abstract Classes

Developing new classes is easier after you understand the concept of inheritance. When you use a class as a basis from which to create extended child classes, the child classes are more specific than their parent. When you create a child class, it inherits all the general attributes you need; thus, you must create only the new, more specific attributes. For example, a `SalariedEmployee` and an `HourlyEmployee` are more specific than an `Employee`. They can inherit general `Employee` attributes, such as an employee number, but they add specific attributes, such as pay-calculating methods.

Notice that a superclass contains the features that are shared by its subclasses. For example, the attributes of the `Dog` class are shared by every `Poodle` and `Spaniel`. The subclasses are more specific examples of the superclass type; they add more features to the shared, general features. Conversely, when you examine a subclass, you see that its parent is more general and less specific; for example, `Animal` is more general than `Dog`.



Recall from Chapter 10 that the terms *base class*, *superclass*, and *parent* are equivalent. Similarly, the terms *derived class*, *subclass*, and *child* are equivalent. Also recall that a child class contains all the members of its parent, whether those members are **public**, **protected**, or **private**. However, a child object cannot directly access a **private** member inherited from a parent.

A **concrete class** is one from which you can instantiate objects. Sometimes, a class is so general that you never intend to create any specific instances of the class. For example, you might never create an object that is “just” an `Employee`; each `Employee` is more specifically a `SalariedEmployee`, `HourlyEmployee`, or `ContractEmployee`. A class such as `Employee` that you create only to extend from is not a concrete class; it is an **abstract class**. In the last chapter, you learned that you can create **final** classes if you do not want other classes to be able to extend them. Classes that you declare to be abstract are the opposite; your only purpose in creating them is to enable other classes to extend them. If you attempt to instantiate an object from an abstract class, you receive an error message from the compiler that you have committed an `InstantiationError`. You use the keyword **abstract** when you declare an abstract class. (In other programming languages, such as C++, abstract classes are known as **virtual classes**.)



In the last chapter, you learned to create class diagrams. By convention, when you show abstract classes and methods in class diagrams, their names appear in italics.



In Chapter 4, you worked with the `GregorianCalendar` class. `GregorianCalendar` is a concrete class that extends the abstract class `Calendar`. In other words, there are no “plain” `Calendar` objects.

Programmers of an abstract class can include two method types:

- Nonabstract methods, like those you can create in any class, are implemented in the abstract class and are simply inherited by its children.
- **Abstract methods** have no body and must be implemented in child classes.



Abstract classes usually contain at least one abstract method. When you create an abstract method, you provide the keyword `abstract` and the rest of the method header, including the method type, name, and parameters. However, the declaration ends there: you do not provide curly braces or any statements within the method—just a semicolon at the end of the declaration. If you create an empty method within an abstract class, the method is an abstract method even if you do not explicitly use the keyword `abstract` when defining the method, but programmers often include the keyword for clarity. If you declare a class to be abstract, its methods can be abstract or not, but if you declare a method to be abstract, you must also declare its class to be abstract.

When you create a subclass that inherits an abstract method, you write a method with the same signature. You are required to code a subclass method to override every empty, abstract superclass method that is inherited. Either the child class method must itself be abstract, or you must provide a body, or implementation, for the inherited method.

Suppose you want to create classes to represent different animals, such as `Dog` and `Cow`. You can create a generic abstract class named `Animal` so you can provide generic data fields, such as the animal's name, only once. An `Animal` is generic, but all specific `Animals` make a sound; the actual sound differs from `Animal` to `Animal`. If you code an empty `speak()` method in the abstract `Animal` class, you require all future `Animal` subclasses to code a `speak()` method that is specific to the subclass. Figure 11-1 shows an abstract `Animal` class containing a data field for the name, `getName()` and `setName()` methods, and an abstract `speak()` method.

```
public abstract class Animal
{
    private String name;
    public abstract void speak();
    public String getName()
    {
        return name;
    }
    public void setName(String animalName)
    {
        name = animalName;
    }
}
```

**Figure 11-1** The abstract `Animal` class

The `Animal` class in Figure 11-1 is declared as `abstract`; the keyword is shaded. You cannot create a class in which you declare an `Animal` object with a statement such as `Animal myPet = new Animal("Murphy");`, because a class that attempts to instantiate an `Animal` object does not compile. `Animal` is an abstract class, so no `Animal` objects can exist.

You create an abstract class such as `Animal` only so you can extend it. For example, because a dog is an animal, you can create a `Dog` class as a child class of `Animal`. Figure 11-2 shows a `Dog` class that extends `Animal`.

```
public class Dog extends Animal
{
    public void speak()
    {
        System.out.println("Woof!");
    }
}
```

**Figure 11-2** The Dog class

The `speak()` method within the `Dog` class is required because you want to create `Dog` objects and the abstract, parent `Animal` class contains an abstract `speak()` method. You can code any statements you want within the `Dog speak()` method, but the `speak()` method must exist. If you do not want to create `Dog` objects but want the `Dog` class to be a parent to further subclasses, then the `Dog` class must also be abstract. In that case, you can write code for the `speak()` method within the subclasses of `Dog`.

If `Animal` is an abstract class, you cannot instantiate an `Animal` object; however, if `Dog` is a concrete class, instantiating a `Dog` object is perfectly legal. When you code the following, you create a `Dog` object:

```
Dog myPet = new Dog("Murphy");
```

Then, when you code `myPet.speak();`, the correct `Dog speak()` method executes.

The classes in Figures 11-3 and 11-4 also inherit from the `Animal` class and implement `speak()` methods. Figure 11-5 contains a `UseAnimals` application.

```
public class Cow extends Animal
{
    public void speak()
    {
        System.out.println("Moo!");
    }
}
```

**Figure 11-3** The Cow class

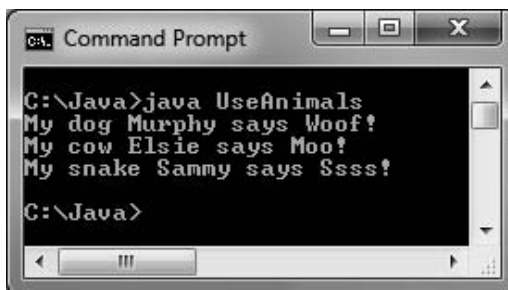
```
public class Snake extends Animal
{
    public void speak()
    {
        System.out.println("Ssss!");
    }
}
```

**Figure 11-4** The Snake class

```
public class UseAnimals
{
    public static void main(String[] args)
    {
        Dog myDog = new Dog();
        Cow myCow = new Cow();
        Snake mySnake = new Snake();
        myDog.setName("My dog Murphy");
        myCow.setName("My cow Elsie");
        mySnake.setName("My snake Sammy");
        System.out.print(myDog.getName() + " says ");
        myDog.speak();
        System.out.print(myCow.getName() + " says ");
        myCow.speak();
        System.out.print(mySnake.getName() + " says ");
        mySnake.speak();
    }
}
```

**Figure 11-5** The UseAnimals application

The output in Figure 11-6 shows that when you create Dog, Cow, and Snake objects, each is an Animal with access to the Animal class getName() and setName() methods, and each uses its own speak() method appropriately. In Figure 11-6, notice how the myDog.getName() and myDog.speak() method calls produce different output from when the same method names are used with myCow and mySnake.



```
CAL Command Prompt
C:\Java>java UseAnimals
My dog Murphy says Woof!
My cow Elsie says Moo!
My snake Sammy says Ssss!
C:\Java>
```

**Figure 11-6** Output of the UseAnimals application



Recall that using the same method name to indicate different implementations is *polymorphism*. Using polymorphism, one method name causes different and appropriate actions for diverse types of objects.



Watch the video *Abstract Classes*.

## TWO TRUTHS & A LIE

### Creating and Using Abstract Classes

1. An abstract class is one from which you cannot inherit, but from which you can create concrete objects.
2. Abstract classes usually have one or more empty abstract methods.
3. An abstract method has no body, curly braces, or statements.

The false statement is #1. An abstract class is one from which you cannot create any concrete objects, but from which you can inherit.

## Using Dynamic Method Binding

When you create a superclass and one or more subclasses, each object of each subclass “is a” superclass object. Every `SalariedEmployee` “is an” `Employee`; every `Dog` “is an” `Animal`. (The opposite is not true. Superclass objects are not members of any of their subclasses. An `Employee` is not a `SalariedEmployee`. An `Animal` is not a `Dog`.) Because every subclass object “is a” superclass member, you can convert subclass objects to superclass objects.

As you are aware, when a superclass is abstract, you cannot instantiate objects of the superclass; however, you can indirectly create a reference to a superclass abstract object. A reference is not an object, but it points to a memory address. When you create a reference, you do not use the keyword `new` to create a concrete object; instead, you create a variable name in which you can hold the memory address of a concrete object. So, although a reference to an abstract superclass object is not concrete, you can store a concrete subclass object reference there.



You learned how to create a reference in Chapter 4. When you code `SomeClass someObject;`, you are creating a reference. If you later code the following statement, including the keyword `new` and the constructor name, then you actually set aside memory for `someObject`:

```
someObject = new SomeClass();
```

For example, if you create an `Animal` class, as shown previously in Figure 11-1, and various subclasses, such as `Dog`, `Cow`, and `Snake`, as shown in Figures 11-2 through 11-4, you can create an application containing a generic `Animal` reference variable into which you can assign any of the concrete `Animal` child objects. Figure 11-7 shows an `AnimalReference` application, and Figure 11-8 shows its output. The variable `animalRef` is a type of `Animal`. No superclass `Animal` object is created (none can be); instead, `Dog` and `Cow` objects are created using the `new` keyword. When the `Cow` object is assigned to the `Animal` reference, the `animalRef.speak()` method call results in “Moo!”; when the `Dog` object is assigned to the `Animal` reference, the method call results in “Woof!”

```

public class AnimalReference
{
    public static void main(String[] args)
    {
        Animal animalRef;
        animalRef = new Cow();
        animalRef.speak();
        animalRef = new Dog();
        animalRef.speak();
    }
}

```

**Figure 11-7** The `AnimalReference` application



Recall from Chapter 2 that when you assign a variable or constant of one type to a variable of another type, the behavior is called *promotion* or *implicit conversion*. In Chapter 10, you also learned that such promotion is called *upcasting*.

The application in Figure 11-7 shows that using a reference polymorphically allows you to extend a base class and use extended objects when a base class type is expected. For example, you could pass a `Dog` or a `Cow` to a method that expects an `Animal`. This means that all methods written to accept a superclass argument can also be used with its children—a feature that saves child-class creators a lot of work.

```

C:\Java>java AnimalReference
Moo?
Woof?
C:\Java>

```

**Figure 11-8** Output of the `AnimalReference` application



Recall from Chapter 10 that you can use the `instanceof` keyword to determine whether an object is an instance of any class in its hierarchy. For example, both of the following expressions are true if `myPoodle` is a `Dog` object:

```

myPoodle instanceof Animal
myPoodle instanceof Dog

```

The application in Figure 11-7 demonstrates polymorphic behavior. The same statement, `animalRef.speak();`, repeats after `animalRef` is assigned each new animal type. Each call to the `speak()` method results in different output. Each reference “chooses” the correct `speak()` method, based on the type of animal referenced. This flexible behavior is most useful when you pass references to methods; you will learn more about this in the next section. In the last chapter, you learned that in Java all instance method calls are virtual method calls by default—the method that is used is determined when the program runs, because the type of the object used might not be known until the method executes. An application’s ability to select the correct subclass method is known as **dynamic method binding**. When the

application executes, the correct method is attached (or bound) to the application based on the current, changing (dynamic) context. Dynamic method binding is also called **late method binding**. The opposite of dynamic method binding is **static (fixed) method binding**. In Java, instance methods (those that receive a `this` reference) use dynamic binding; class methods use static method binding. Dynamic binding makes programs flexible; however, static binding operates more quickly.



In the example in this section, the objects using `speak()` happen to be related (Cow and Dog are both Animals). Be aware that polymorphic behavior can apply to nonrelated classes as well. For example, a `DebateStudent` and a `VentriloquistsDummy` might also `speak()`. When polymorphic behavior depends on method overloading, it is called **ad-hoc polymorphism**; when it depends on using a superclass as a method parameter, it is called **pure polymorphism** or **inclusion polymorphism**.

## Using a Superclass as a Method Parameter Type

Dynamic method binding is most useful when you want to create a method that has one or more parameters that might be one of several types. For example, the shaded header for the `talkingAnimal()` method in Figure 11-9 accepts any type of `Animal` argument. The method can be used in programs that contain `Dog` objects, `Cow` objects, or objects of any other class that descends from `Animal`. The application in Figure 11-9 passes first a `Dog` and then a `Cow` to the method. The output in Figure 11-10 shows that the method works correctly no matter which type of `Animal` descendant it receives.

```
public class TalkingAnimalDemo
{
    public static void main(String[] args)
    {
        Dog dog = new Dog();
        Cow cow = new Cow();
        dog.setName("Ginger");
        cow.setName("Molly");
        talkingAnimal(dog);
        talkingAnimal(cow);
    }
    public static void talkingAnimal(Animal animal)
    {
        System.out.println("Come one. Come all.");
        System.out.println
            ("See the amazing talking animal!");
        System.out.println(animal.getName() +
            " says");
        animal.speak();
        System.out.println("*****");
    }
}
```

**Figure 11-9** The `TalkingAnimalDemo` class

```

C:\Java>java TalkingAnimalDemo
Come one. Come all.
See the amazing talking animal!
Ginger says
Woof!
*****
Come one. Come all.
See the amazing talking animal!
Molly says
Moo!
*****
C:\Java>_

```

**Figure 11-10** Output of the TalkingAnimalDemo application

## TWO TRUTHS & A LIE

### Using Dynamic Method Binding

1. If Parent is a parent class and Child is its child, then you can assign a Child object to a Parent reference.
2. If Parent is a parent class and Child is its child, then you can assign a Parent object to a Child reference.
3. Dynamic method binding refers to a program's ability to select the correct subclass method for a superclass reference while a program is running.

The false statement is #2. If Parent is a parent class and Child is its child, then you cannot assign a Parent object to a Child reference; you can only assign a Child object to a Parent reference. However, you can assign a Parent object or a

## Creating Arrays of Subclass Objects

Recall that every array element must be the same data type, which can be a primitive, built-in type or a type based on a more complex class. When you create an array in Java, you are not constructing objects. Instead, you are creating space for references to objects. In other words, although it is convenient to refer to “an array of objects,” every array of objects is really an array of object references. When you create an array of superclass references, it can hold subclass references. This is true whether the superclass in question is abstract or concrete.

For example, even though Employee is an abstract class, and every Employee object is either a SalariedEmployee or an HourlyEmployee subclass object, it can be convenient to create an array of generic Employee references. Likewise, an Animal array might contain individual elements that

are `Dog`, `Cow`, or `Snake` objects. As long as every `Employee` subclass has access to a `calculatePay()` method, and every `Animal` subclass has access to a `speak()` method, you can manipulate an array of superclass objects and invoke the appropriate method for each subclass member.

The following statement creates an array of three `Animal` references:

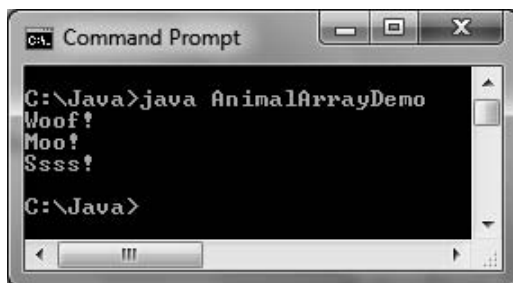
```
Animal[] animalRef = new Animal[3];
```

The statement reserves enough computer memory for three `Animal` objects named `animalRef[0]`, `animalRef[1]`, and `animalRef[2]`. The statement does not actually instantiate `Animals`; `Animal` is an abstract class and cannot be instantiated. The `Animal` array declaration simply reserves memory for three object references. If you instantiate objects from `Animal` subclasses, you can place references to those objects in the `Animal` array, as Figure 11-11 illustrates. Figure 11-12 shows the output of the `AnimalArrayDemo` application. The array of three references is used to access each appropriate `speak()` method.

478

```
public class AnimalArrayDemo
{
    public static void main(String[] args)
    {
        Animal[] animalRef = new Animal[3];
        animalRef[0] = new Dog();
        animalRef[1] = new Cow();
        animalRef[2] = new Snake();
        for(int x = 0; x < 3; ++x)
            animalRef[x].speak();
    }
}
```

Figure 11-11 The `AnimalArrayDemo` application



```
cmd. Command Prompt
C:\Java>java AnimalArrayDemo
Woof!
Moo!
Ssss!
C:\Java>
```

Figure 11-12 Output of the `AnimalArrayDemo` application

In the `AnimalArrayDemo` application in Figure 11-11, a reference to an instance of the `Dog` class is assigned to the first `Animal` reference, and then references to `Cow` and `Snake` objects are assigned to the second and third array elements. After the object references are in the array, you can manipulate them like any other array elements. The application in Figure 11-11 uses a `for` loop and a subscript to get each individual reference to `speak()`.



## TWO TRUTHS &amp; A LIE

## Creating Arrays of Subclass Objects

1. You can assign a superclass reference to an array of its subclass type.
2. The following statement creates an array of 10 `Table` references:  
`Table[] table = new Table[10];`
3. You can assign subclass objects to an array that is their superclass type.

479

The false statement is #1. You can assign a subclass reference to an array of its superclass type, but not the other way around.

## Using the Object Class and Its Methods

Every class in Java is actually a subclass, except one. When you define a class, if you do not explicitly extend another class, your class implicitly is an extension of the `Object` class. The **Object class** is defined in the `java.lang` package, which is imported automatically every time you write a program; in other words, the following two class declarations have identical outcomes:

```
public class Animal
{
}
public class Animal extends Object
{
}
```

When you declare a class that does not extend any other class, you always are extending the `Object` class. The `Object` class includes methods that descendant classes can use or override as you see fit. Table 11-1 describes the methods built into the `Object` class; every `Object` you create has access to these methods.

Method	Description
<code>Object clone()</code>	Creates and returns a copy of this object
<code>boolean equals(Object obj)</code>	Indicates whether some object is equal to the parameter object (this method is described in detail below)
<code>void finalize()</code>	Called by the garbage collector on an object when there are no more references to the object
<code>Class&lt;?&gt; getClass()</code>	Returns the class to which this object belongs at run time

**Table 11-1** Object class methods (continues)

*(continued)*

Method	Description
<code>int hashCode()</code>	Returns a hash code value for the object (this method is described briefly below)
<code>void notify()</code>	Wakes up a single thread that is waiting on this object's monitor
<code>void notifyAll()</code>	Wakes up all threads that are waiting on this object's monitor
<code>String toString()</code>	Returns a string representation of the object (this method is described in detail below)
<code>void wait(long timeout)</code>	Causes the current thread to wait until either another thread invokes the <code>notify()</code> method or the <code>notifyAll()</code> method for this object, or a specified amount of time has elapsed
<code>void wait(long timeout, int nanos)</code>	Causes the current thread to wait until another thread invokes the <code>notify()</code> or <code>notifyAll()</code> method for this object, or some other thread interrupts the current thread, or a certain amount of real time has elapsed

**Table 11-1** Object class methods

## Using the `toString()` Method

The `Object` class **`toString()` method** converts an `Object` into a `String` that contains information about the `Object`. Within a class, if you do not create a `toString()` method that overrides the version in the `Object` class, you can use the superclass version of the `toString()` method. For example, examine the `Dog` class originally shown in Figure 11-2 and repeated in Figure 11-13. Notice that it does not contain a `toString()` method and that it extends the `Animal` class.

```
public abstract class Animal
{
    private String name;
    public abstract void speak();
    public String getName()
    {
        return name;
    }
    public void setName(String animalName)
    {
        name = animalName;
    }
}
```

**Figure 11-13** The `Animal` and `Dog` classes and the `DisplayDog` application (*continues*)

*(continued)*

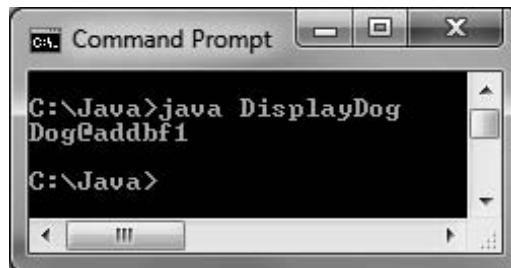
```

public class Dog extends Animal
{
    public void speak()
    {
        System.out.println("Woof!");
    }
}
public class DisplayDog
{
    public static void main(String[] args)
    {
        Dog myDog = new Dog();
        String dogString = myDog.toString();
        System.out.println(dogString);
    }
}

```

**Figure 11-13** The `Animal` and `Dog` classes and the `DisplayDog` application

Notice that neither the `Animal` class nor the `Dog` class in Figure 11-13 defines a `toString()` method. Yet, when you write the `DisplayDog` application in Figure 11-13, it uses a `toString()` method with a `Dog` object in the shaded statement. The class compiles correctly, converts the `Dog` object to a `String`, and produces the output shown in Figure 11-14 because `Dog` inherits `toString()` from `Object`.

**Figure 11-14** Output of the `DisplayDog` application

The output of the `DisplayDog` application in Figure 11-14 is not very useful. It consists of the class name of which the object is an instance (`Dog`), the at sign (`@`), and a hexadecimal (base 16) number that represents a unique identifier for every object in the current application. The hexadecimal number that is part of the `String` returned by the `toString()` method is an example of a **hash code**—a calculated number used to identify an object. Later in this chapter, you learn about the `equals()` method, which also uses a hash code.

Instead of using the automatic `toString()` method with your classes, it is usually more useful to write your own overloaded version that displays some or all of the data field values for the object with which you use it. A good `toString()` method can be very useful in debugging a program; if you do not understand why a class is behaving as it is, you can display the `toString()` value and examine its contents. For example, Figure 11-15 shows a `BankAccount` class that contains a mistake in the shaded line—the `BankAccount` balance value is set to the account number instead of the balance amount. Of course, if you made such a mistake within one of your own classes, there would be no shading or comment to help you find the mistake. In addition, a useful `BankAccount` class would be much larger, so the mistake would be more

difficult to locate. However, when you run programs containing `BankAccount` objects, you would notice that the balances of your `BankAccounts` were incorrect. To help you discover why, you could create a short application like the `TestBankAccount` class in Figure 11-16. This application uses the `BankAccount` class `toString()` method to display the relevant details of a `BankAccount` object. The output of the `TestBankAccount` application appears in Figure 11-17.

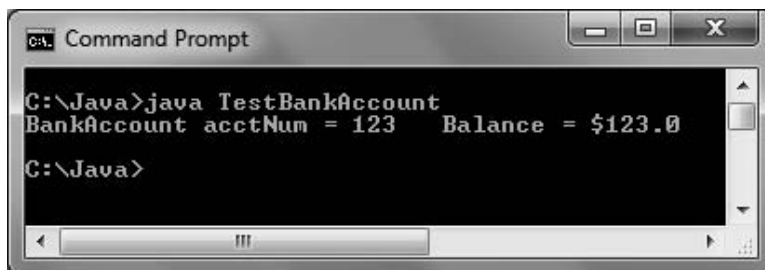
```
public class BankAccount
{
    private int acctNum;
    private double balance;
    public BankAccount(int num, double bal)
    {
        acctNum = num;
        balance = num;
    }
    public String toString()
    {
        String info = "BankAccount acctNum = " + acctNum +
            " Balance = $" + balance;
        return info;
    }
}
```

**Don't Do It**  
The `bal` parameter, not the `num` parameter, should be assigned to `balance`.

Figure 11-15 The `BankAccount` class

```
public class TestBankAccount
{
    public static void main(String[] args)
    {
        BankAccount myAccount = new BankAccount(123, 4567.89);
        System.out.println(myAccount.toString());
    }
}
```

Figure 11-16 The `TestBankAccount` application



```
Command Prompt
C:\Java>java TestBankAccount
BankAccount acctNum = 123 Balance = $123.0
C:\Java>
```

Figure 11-17 Output of the flawed `TestBankAccount` application

From the output in Figure 11-17, you can see that the account number and balance have the same value, and this knowledge might help you to pin down the location of the incorrect statement in the `BankAccount` class. Of course, you do not have to use a method named `toString()` to discover a `BankAccount`'s attributes. If the class had methods such as `getAcctNum()` and `getBalance()`, you could use them to create a similar application. The advantage of creating a `toString()` method for your classes is that `toString()` is Java's conventional name for a method that converts an object's relevant details into `String` format. Because `toString()` originates in the `Object` class, you can be assured that `toString()` compiles with any object whose details you want to see, even if the method has not been rewritten for the subclass in question. In addition, as you write your own applications and use classes written by others, you can hope that those programmers have overridden `toString()` to provide useful information. You don't have to search documentation to discover a useful method—instead you can rely on the likely usefulness of `toString()`.



In Chapter 7, you learned that you can use the `toString()` method to convert any object to a `String`. Now you understand why this works—the `String` class overloads the `Object` class `toString()` method.

## Using the `equals()` Method

The `Object` class also contains an **`equals()` method** that takes a single argument, which must be the same type as the type of the invoking object, as in the following example:

```
if(someObject.equals(someOtherObjectOfTheSameType))
    System.out.println("The objects are equal ");
```



Other classes, such as the `String` class, also have their own `equals()` methods that overload the `Object` class method. You first used the `equals()` method to compare `String` objects in Chapter 7. Two `String` objects are considered equal only if their `String` contents are identical.

The `Object` class `equals()` method returns a `boolean` value indicating whether the objects are equal. This `equals()` method considers two objects of the same class to be equal only if they have the same hash code; in other words, they are equal only if one is a reference to the other. For example, two `BankAccount` objects named `myAccount` and `yourAccount` are not automatically equal, even if they have the same account numbers and balances; they are equal only if they have the same memory address. If you want to consider two objects to be equal only when one is a reference to the other, you can use the built-in `Object` class `equals()` method. However, if you want to consider objects to be equal based on their contents, you must write your own `equals()` method for your classes.



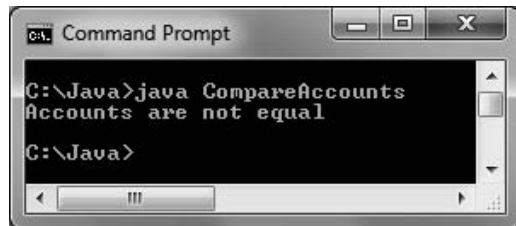
Java's `Object` class contains a `public` method named `hashCode()` that returns an integer representing the hash code. (Discovering this number is of little use to you. The default hash code is the internal JVM memory address of the object.) However, whenever you override the `equals()` method in a professional class, you generally want to override the `hashCode()` method as well, because equal objects should have equal hash codes, particularly if the objects will be used in hash-based methods. See the documentation at <http://java.sun.com> for more details.

The application shown in Figure 11-18 instantiates two `BankAccount` objects, using the `BankAccount` class in Figure 11-15. The `BankAccount` class does not include its own `equals()` method, so it does not override the `Object equals()` method. Thus, the application in Figure 11-18 produces the output in Figure 11-19. Even though the two `BankAccount` objects have the same account numbers and balances, the `BankAccounts` are not considered equal because they do not have the same memory address.

```
public class CompareAccounts
{
    public static void main(String[] args)
    {
        BankAccount acct1 = new BankAccount(1234, 500.00);
        BankAccount acct2 = new BankAccount(1234, 500.00);
        if(acct1.equals(acct2))
            System.out.println("Accounts are equal");
        else
            System.out.println("Accounts are not equal");
    }
}
```

**Figure 11-18** The `CompareAccounts` application

If your intention is that within applications, two `BankAccount` objects with the same account number and balance are equal, and you want to use the `equals()` method to make the comparison, you must write your own `equals()` method within the `BankAccount` class. For example, Figure 11-20 shows a new version of the `BankAccount` class containing a shaded `equals()` method. When you re-execute the `CompareAccounts` application in Figure 11-18, the result appears as in Figure 11-21.



```
Command Prompt
C:\Java>java CompareAccounts
Accounts are not equal
C:\Java>
```

**Figure 11-19** Output of the `CompareAccounts` application

```
public class BankAccount
{
    private int acctNum;
    private double balance;
    public BankAccount(int num, double bal)
    {
        acctNum = num;
        balance = bal;
    }
}
```

**Figure 11-20** The `BankAccount` class containing its own `equals()` method (*continues*)

*(continued)*

```

public String toString()
{
    String info = "BankAccount acctNum = " + acctNum +
        "    Balance = $" + balance;
    return info;
}
public boolean equals(BankAccount secondAcct)
{
    boolean result;
    if(acctNum == secondAcct.acctNum &&
        balance == secondAcct.balance)
        result = true;
    else
        result = false;
    return result;
}
}

```

**Figure 11-20** The BankAccount class containing its own equals() method

The two BankAccount objects described in the output in Figure 11-21 are equal because their account numbers and balances match. Because the equals() method in Figure 11-20 is part of the BankAccount class, and because equals() is a nonstatic method, the object that calls the method is held by the this reference within the method. That is, in the application in Figure 11-18, acct1 becomes the this reference in the equals() method, so the fields acctNum and balance refer to acct1 object values. In the CompareAccounts application, acct2 is the argument to the equals() method, so within the equals() method, acct2 becomes secondAcct, and secondAcct.acctNum and secondAcct.balance refer to acct2's values.

**Figure 11-21** Output of the CompareAccounts application after adding an overloaded equals() method to the BankAccount class

Your organization might consider two BankAccount objects equal if their account numbers match, disregarding their balances. If so, you simply change the if clause in the equals() method. Or, you might decide accounts are equal based on some other criteria. You can implement the equals() method in any way that suits your needs. When you want to compare the contents of two objects, you do not have to overload the Object class equals() method. Instead, you could write a method with a unique name, such as areTheyEqual() or areContentsSame(). However, as with the toString() method, users of your classes will appreciate that you use the expected, usual, and conventional identifiers for your methods.



If you change a class (such as changing `BankAccount` by adding a new method), not only must you recompile the class, you must also recompile any client applications (such as `CompareAccounts`) so the newly updated class can be relinked to the application and so the clients include the new features of the altered class. If you execute the `CompareAccounts` application but do not recompile `BankAccount`, the application continues to use the previously compiled version of the class.



Watch the video *The Object Class*.

## TWO TRUTHS & A LIE

### Using the Object Class and Its Methods

1. When you define a class, if you do not explicitly extend another class, your class is an extension of the `Object` class.
2. The `Object` class is defined in the `java.lang` package, which is imported automatically every time you write a program.
3. The `Object` class `toString()` and `equals()` methods are abstract.

The false statement is #3. The `toString()` and `equals()` methods are not abstract—you are not required to override them in a subclass.

## Using Inheritance to Achieve Good Software Design

When an automobile company designs a new car model, the company does not build every component of the new car from scratch. The company might design a new feature completely from scratch; for example, at some point someone designed the first air bag. However, many of a new car's features are simply modifications of existing features. The manufacturer might create a larger gas tank or more comfortable seats, but even these new features still possess many properties of their predecessors in the older models. Most features of new car models are not even modified; instead, existing components, such as air filters and windshield wipers, are included on the new model without any changes.

Similarly, you can create powerful computer programs more easily if many of their components are used either “as is” or with slight modifications. Inheritance does not give you the ability to write programs that you could not write otherwise. If Java did not allow you to extend classes, you *could* create every part of a program from scratch. Inheritance simply makes your job easier. Professional programmers constantly create new class libraries for use with Java programs. Having these classes available makes programming large systems more manageable.

You have already used many “as is” classes, such as `System` and `String`. In these cases, your programs were easier to write than if you had to write these classes yourself. Now that you have learned about inheritance, you have gained the ability to modify existing classes. When you create a useful, extendable superclass, you and other future programmers gain several advantages:



- Subclass creators save development time because much of the code needed for the class has already been written.
- Subclass creators save testing time because the superclass code has already been tested and probably used in a variety of situations. In other words, the superclass code is reliable.
- Programmers who create or use new subclasses already understand how the superclass works, so the time it takes to learn the new class features is reduced.
- When you create a new subclass in Java, neither the superclass source code nor the superclass bytecode is changed. The superclass maintains its integrity.

When you consider classes, you must think about the commonalities among them; then you can create superclasses from which to inherit. You might be rewarded professionally when you see your own superclasses extended by others in the future.

## TWO TRUTHS & A LIE

### Using Inheritance to Achieve Good Software Design

1. If object-oriented programs did not support inheritance, programs could still be written, but they would be harder to write.
2. When you create a useful, extendable superclass, you save development and testing time.
3. When you create a new subclass in Java, you must remember to revise and recompile the superclass code.

The false statement is #3. When you create a new subclass in Java, neither the superclass source code nor the superclass bytecode is changed.

## Creating and Using Interfaces

Some object-oriented programming languages, such as C++, allow a subclass to inherit from more than one parent class. For example, you might create an `InsuredItem` class that contains data fields pertaining to each possession for which you have insurance. Data fields might include the name of the item, its value, the insurance policy type, and so on. You might also create an `Automobile` class that contains data fields such as vehicle identification number, make, model, and year. When you create an `InsuredAutomobile` class for a car rental agency, you might want to include `InsuredItem` information and methods, as well as `Automobile` information and methods. It would be convenient to inherit from both the `InsuredItem` and `Automobile` classes. The capability to inherit from more than one class is called **multiple inheritance**.

Many programmers consider multiple inheritance to be a difficult concept, and when inexperienced programmers use it they encounter many problems. Programmers have to deal with the possibility that variables and methods in the parent classes might have identical names, which creates conflict when the child class uses one of the names. Also, you have already learned

that a child class constructor must call its parent class constructor. When there are two or more parents, this task becomes more complicated—to which class should `super()` refer when a child class has multiple parents? For all of these reasons, multiple inheritance is prohibited in Java.

488



In Java, a class can inherit from a superclass that has inherited from another superclass—this represents single inheritance with multiple generations. What Java does not allow is for a class to inherit directly from two or more parents.

Java, however, does provide an alternative to multiple inheritance—an interface. An **interface** looks much like a class, except that all of its methods (if any) are implicitly `public` and `abstract`, and all of its data items (if any) are implicitly `public`, `static`, and `final`. An interface is a description of what a class does, but not how it is done; it declares method headers, but not the instructions within those methods. When you create a class that uses an interface, you include the keyword `implements` and the interface name in the class header. This notation requires the class to include an implementation for every method named in the interface. Whereas using `extends` allows a subclass to use nonprivate, nonoverridden members of its parent's class, `implements` requires the subclass to implement its own version of each method.



In English, an interface is a device or a system that unrelated entities use to interact. Within Java, an interface provides a way for unrelated objects to interact with each other. An interface is analogous to a protocol, which is an agreed-on behavior. In some respects, an `Automobile` can behave like an `InsuredItem`, and so can a `House`, a `TelevisionSet`, and a `JewelryPiece`.

As an example, recall the `Animal` and `Dog` classes from earlier in this chapter. Figure 11-22 shows these classes, with `Dog` inheriting from `Animal`.

```
public abstract class Animal
{
    private String name;
    public abstract void speak();
    public String getName()
    {
        return name;
    }
    public void setName(String animalName)
    {
        name = animalName;
    }
}
public class Dog extends Animal
{
    public void speak()
    {
        System.out.println("Woof!");
    }
}
```

Figure 11-22 The `Animal` and `Dog` classes

You can create a `Worker` interface, as shown in Figure 11-23. For simplicity, this example gives the `Worker` interface a single method named `work()`. When any class implements `Worker`, it must either include a `work()` method or the new class must be declared abstract, and then its descendants must implement the method.

```
public interface Worker
{
    public void work();
}
```

**Figure 11-23** The `Worker` interface

The `WorkingDog` class in Figure 11-24 extends `Dog` and implements `Worker`. A `WorkingDog` contains a data field that a “regular” `Dog` does not—an integer that holds hours of training received. The `WorkingDog` class also contains get and set methods for this field. Because the `WorkingDog` class implements the `Worker` interface, it also must contain a `work()` method that calls the `Dog speak()` method, and then produces two more lines of output—a statement about working and the number of training hours.

```
public class WorkingDog extends Dog implements Worker
{
    private int hoursOfTraining;
    public void setHoursOfTraining(int hrs)
    {
        hoursOfTraining = hrs;
    }
    public int getHoursOfTraining()
    {
        return hoursOfTraining;
    }
    public void work()
    {
        speak();
        System.out.println("I am a dog who works");
        System.out.println("I have " + hoursOfTraining +
            " hours of professional training!");
    }
}
```

**Figure 11-24** The `WorkingDog` class



As you know from other classes you have seen, a class can extend another class without implementing any interfaces. A class can also implement an interface even though it does not extend any other class. When a class both extends and implements, like the `WorkingDog` class, by convention the `implements` clause follows the `extends` clause in the class header.

The `DemoWorkingDogs` application in Figure 11-25 instantiates two `WorkingDog` objects. Each object can use the following methods:

- The `setName()` and `getName()` methods that `WorkingDog` inherits from the `Animal` class
- The `speak()` method that `WorkingDog` inherits from the `Dog` class
- The `setHoursOfTraining()` and `getHoursOfTraining()` methods contained within the `WorkingDog` class
- The `work()` method that the `WorkingDog` class was required to contain when it used the phrase `implements Worker`; the `work()` method also calls the `speak()` method contained in the `Dog` class

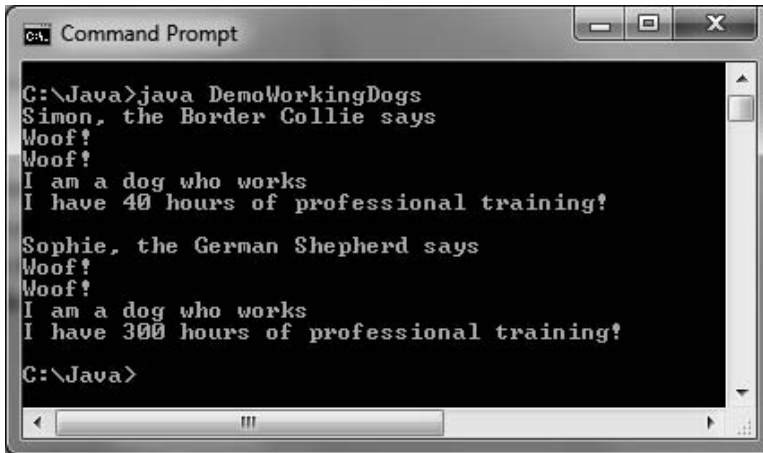
```
public class DemoWorkingDogs
{
    public static void main(String[] args)
    {
        WorkingDog aSheepHerder = new WorkingDog();
        WorkingDog aSeeingEyeDog = new WorkingDog();
        aSheepHerder.setName("Simon, the Border Collie");
        aSeeingEyeDog.setName("Sophie, the German Shepherd");
        aSheepHerder.setHoursOfTraining(40);
        aSeeingEyeDog.setHoursOfTraining(300);

        System.out.println(aSheepHerder.getName() + " says ");
        aSheepHerder.speak();
        aSheepHerder.work();
        System.out.println(); // outputs a blank line for readability

        System.out.println(aSeeingEyeDog.getName() + " says ");
        aSeeingEyeDog.speak();
        aSeeingEyeDog.work();
    }
}
```

**Figure 11-25** The `DemoWorkingDogs` application

Figure 11-26 shows the output when the `DemoWorkingDogs` application executes. Each animal is introduced, then it “speaks,” and then each animal “works,” which includes speaking a second time. Each `Animal` can execute the `speak()` method implemented in its own class, and each can execute the `work()` method contained in the implemented interface. Of course, the `WorkingDog` class was not required to implement the `Worker` interface; instead, it could have just contained a `work()` method that all `WorkingDog` objects could use. If `WorkingDog` was the only class that would ever use `work()`, such an approach would probably be the best course of action. However, if many classes will be `Workers`—that is, require a `work()` method—they all can implement `work()`. If you are already familiar with the `Worker` interface and its method, when you glance at a class definition for a `WorkingHorse`, `WorkingBird`, or `Employee` and see that it implements `Worker`, you do not have to guess at the name of the method that shows the work the class objects perform.



```

C:\Java>java DemoWorkingDogs
Simon, the Border Collie says
Woof!
Woof!
I am a dog who works
I have 40 hours of professional training!

Sophie, the German Shepherd says
Woof!
Woof!
I am a dog who works
I have 300 hours of professional training!

C:\Java>

```

**Figure 11-26** Output of the DemoWorkingDogs application



Notice that when a class implements an interface, it represents a situation similar to inheritance. Just as a `WorkingDog` “is a” `Dog` and “is an” `Animal`, so too it “is a” `Worker`.

You can compare abstract classes and interfaces as follows:

- Abstract classes and interfaces are similar in that you cannot instantiate concrete objects from either one.
- Abstract classes differ from interfaces because abstract classes can contain nonabstract methods, but all methods within an interface must be abstract.
- A class can inherit from only one abstract superclass, but it can implement any number of interfaces.

Beginning programmers sometimes find it difficult to decide when to create an abstract superclass and when to create an interface. Remember, you create an abstract class when you want to provide data or methods that subclasses can inherit, but at the same time these subclasses maintain the ability to override the inherited methods.

Suppose you create a `CardGame` class to use as a base class for different card games. It contains four methods named `shuffle()`, `deal()`, `displayRules()`, and `keepScore()`. The `shuffle()` method works the same way for every `CardGame`, so you write the statements for `shuffle()` within the superclass, and any `CardGame` objects you create later inherit `shuffle()`. The methods `deal()`, `displayRules()`, and `keepScore()` operate differently for every subclass (for example, for `TwoPlayerCardGames`, `FourPlayerCardGames`, `BettingCardGames`, and so on), so you force `CardGame` children to contain instructions for those methods by leaving them empty in the superclass. The `CardGame` class, therefore, should be an abstract superclass. When you write classes that extend the `CardGame` parent class, you inherit the `shuffle()` method, and write code within the `deal()`, `displayRules()`, and `keepScore()` methods for each specific child.

You create an interface when you know what actions you want to include, but you also want every user to separately define the behavior that must occur when the method executes. Suppose you create a `MusicalInstrument` class to use as a base for different musical instrument object classes such as `Piano`, `Violin`, and `Drum`. The parent `MusicalInstrument` class contains methods such as `playNote()` and `outputSound()` that apply to every instrument, but you want to implement these methods differently for each type of instrument. By making `MusicalInstrument` an interface, you require every nonabstract subclass to code all the methods.



An interface specifies only the messages to which an object can respond; an abstract class can include methods that contain the actual behavior the object performs when those messages are received.

You also create an interface when you want a class to implement behavior from more than one parent. For example, suppose that you want to create an interactive `NameThatInstrument` card game in which you play an instrument sound from the computer speaker, and ask players to identify the instrument they hear by clicking one of several cards that display instrument images. This game class could not extend from two classes, but it could extend from `CardGame` and implement `MusicalInstrument`.



When you create a class and use the `implements` clause to implement an interface, but fail to code one of the interface's methods, the compiler error generated indicates that you must declare your class to be `abstract`. If you want your class to be used only for extending, you can make it `abstract`. However, if your intention is to create a class from which you can instantiate objects, do not make it `abstract`. Instead, find out which methods from the interface you have failed to implement within your class and code those methods.



Java has many built-in interfaces with names such as `Serializable`, `Runnable`, `Externalizable`, and `Cloneable`. See the documentation at <http://java.sun.com> for more details.

## Creating Interfaces to Store Related Constants

Interfaces can contain data fields, but they must be `public`, `static`, and `final`. It makes sense that interface data must not be `private` because interface methods cannot contain method bodies; without public method bodies, you have no way to retrieve `private` data. It also makes sense that the data fields in an interface are `static` because you cannot create interface objects. Finally, it makes sense that interface data fields are `final` because, without methods containing bodies, you have no way, other than at declaration, to set the data fields' values, and you have no way to change them.

Your purpose in creating an interface containing constants is to provide a set of data that a number of classes can use without having to redeclare the values. For example, the interface class in Figure 11-27 provides a number of constants for a pizzeria. Any class written for the pizzeria can implement this interface and use the permanent values. Figure 11-28 shows an example of one application that uses each value, and Figure 11-29 shows the output. The application in Figure 11-28 only needs a declaration for the current special price; all the constants, such as the name of the pizzeria, are retrieved from the interface.

```
public interface PizzaConstants
{
    public static final int SMALL_DIAMETER = 12;
    public static final int LARGE_DIAMETER = 16;
    public static final double TAX_RATE = 0.07;
    public static final String COMPANY = "Antonio's Pizzeria";
}
```

Figure 11-27 The PizzaConstants interface

```
public class PizzaDemo implements PizzaConstants
{
    public static void main(String[] args)
    {
        double specialPrice = 11.25;
        System.out.println("Welcome to " + COMPANY);
        System.out.println("We are having a special offer:\na " +
            SMALL_DIAMETER + " inch pizza with four toppings\nor a " +
            LARGE_DIAMETER +
            " inch pizza with one topping\nfor only $" + specialPrice);
        System.out.println("With tax, that is only $" +
            (specialPrice + specialPrice * TAX_RATE));
    }
}
```

Figure 11-28 The PizzaDemo application

```
C:\Java>java PizzaDemo
Welcome to Antonio's Pizzeria
We are having a special offer:
a 12 inch pizza with four toppings
or a 16 inch pizza with one topping
for only $11.25
With tax, that is only $12.0375
C:\Java>_
```

Figure 11-29 Output of the PizzaDemo application



Watch the video *Interfaces*.

## TWO TRUTHS & A LIE

### Creating and Using Interfaces

1. Java's capability to inherit from more than one class is called multiple inheritance.
2. All of the methods in an interface are implicitly `public` and `abstract`, and all of its data items (if any) are implicitly `public`, `static`, and `final`.
3. When a class inherits from another, the child class can use the nonprivate, nonoverridden members of its parent's class, but when a class uses an interface, it must implement its own version of each method.

The false statement is #1. The ability to inherit from more than one class is called multiple inheritance, but Java does not have that ability.

## Creating and Using Packages

Throughout most of this book, you have imported packages into your programs. As you learned in Chapter 4, a package is a named collection of classes; for example, the `java.lang` package contains fundamental classes and is automatically imported into every program you write. You also have created classes into which you explicitly imported optional packages such as `java.util` and `javax.swing`. When you create classes, you can place them in packages so that you or other programmers can easily import your related classes into new programs. Placing classes in packages for other programmers increases the classes' reusability. When you create a number of classes that inherit from each other, as well as multiple interfaces that you want to implement with these classes, you often will find it convenient to place these related classes in a package.



Creating packages encourages others to reuse software because it makes it convenient to import many related classes at once. In Chapter 3, you learned that if you do not use one of the three access specifiers `public`, `private`, or `protected` for a class, then it has default access, which means that the unmodified class is accessible to any other class in the same package.

When you create professional classes for others to use, you most often do not want to provide the users with your source code in the files that have `.java` extensions. You expend significant effort developing workable code for your programs, and you do not want other programmers to be able to copy your programs, make minor changes, and market the new product themselves. Rather, you want to provide users with the compiled files that have `.class` extensions. These are the files the user needs to run the program you have developed. Likewise, when other programmers use the classes you have developed, they need only the completed compiled code to import into their programs. The `.class` files are the files you place in a package so other programmers can import them.



In the Java programming language, a package or class library is often delivered to users as a **Java ARchive (JAR) file**. JAR files compress the data they store, which reduces the size of archived class files. The JAR format is based on the popular Zip file format.



If you do not specify a package for a class, it is placed in an unnamed **default package**. A class that will be placed in a nondefault package for others to use must be `public`. If a class is not `public`, it can be used only by other classes within the same package. To place a class in a package, you include a package declaration at the beginning of the source code file that indicates the folder into which the compiled code will be placed. When a file contains a package declaration, it must be the first statement in the file (excluding comments). If there are import declarations, they follow the package declaration. Within the file, the package statement must appear outside the class definition. The package statement, import statements, and comments are the only statements that appear outside class definitions in Java program files.

For example, the following statement indicates that the compiled file should be placed in a folder named `com.course.animals`:

```
package com.course.animals;
```

That is, the compiled file should be stored in the `animals` subfolder inside the `course` subfolder inside the `com` subfolder (or `com\course\animals`). The pathname can contain as many levels as you want.

When you compile a file that you want to place in a package, you can copy or move the compiled `.class` file to the appropriate folder. Alternatively, you can use a compiler option with the `javac` command. The `-d` (for *directory*) option indicates that you want to place the generated `.class` file in a folder. For example, the following command indicates that the compiled `Animal.java` file should be placed in the directory indicated by the `import` statement within the `Animal.java` file:

```
javac -d . Animal.java
```

The dot (period) in the compiler command indicates that the path shown in the package statement in the file should be created within the current directory.

If the `Animal` class file contains the statement `package com.course.animals;`, the `Animal.class` file is placed in `C:\com\course\animals`. If any of these subfolders do not exist, Java creates them. Similarly, if you package the compiled files for `Dog.java`, `Cow.java`, and so on, future programs need only use the following statements to be able to use all the related classes:

```
import com.course.animals.Dog;  
import com.course.animals.Cow;
```

Because Java is used extensively on the Internet, it is important to give every package a unique name. Sun Microsystems, the creator of Java, has defined a package-naming convention in which you use your Internet domain name in reverse order. For example, if your domain name is `course.com`, you begin all of your package names with `com.course`. Subsequently, you organize your packages into reasonable subfolders.

Creating packages using Java's naming convention helps avoid naming conflicts—different programmers might create classes with the same name, but they are contained in different packages. Class naming conflicts are sometimes called **collisions**. Because of packages, you can create a class without worrying that its name already exists in Java or in packages distributed by another organization. For example, if your domain name is `course.com`, then you might want to create a class named `Scanner` and place it in a

package named `com.course.input`. The fully qualified name of your `Scanner` class is `com.course.input.Scanner`, and the fully qualified name of the built-in `Scanner` class is `java.util.Scanner`.

## TWO TRUTHS & A LIE

### Creating and Using Packages

1. Typically, you place `.class` files in a package so other programmers can import them into their programs.
2. A class that will be placed in a package for others to use must be protected so that others cannot read your source code.
3. Java's creators have defined a package-naming convention in which you use your Internet domain name in reverse order.

The false statement is #2. A class that will be placed in a package for others to use must be `public`. If a class is not `public`, it can be used only by other classes within the same package. To prevent others from viewing your source code, you place compiled `.class` files in distributed packages.

## You Do It

### Creating an Abstract Class

In this section, you will create an abstract `Vehicle` class. The class includes fields for the power source, the number of wheels, and the price. `Vehicle` is an abstract class; there will never be a “plain” `Vehicle` object. Later, you will create two subclasses, `Sailboat` and `Bicycle`; these more specific classes include price limits for the vehicle type, as well as different methods for displaying data.

#### To create an abstract `Vehicle` class:

1. Open a new file in your text editor, and enter the following first few lines to begin creating an abstract `Vehicle` class:

```
public abstract class Vehicle  
{
```

2. Declare the data fields that hold the power source, number of wheels, and price. Declare `price` as protected rather than `private`, because you want child classes to be able to access the field.

```
private String powerSource;  
private int wheels;  
protected int price;
```

- The `Vehicle` constructor accepts three parameters and calls three methods. The first method accepts the `powerSource` parameter, the second accepts the `wheels` parameter, and the third method prompts the user for a vehicle price.

```
public Vehicle(String powerSource, int wheels)
{
    setPowerSource(powerSource);
    setWheels(wheels);
    setPrice();
}
```

- Include the following three get methods that return the values for the data fields:

```
public String getPowerSource()
{
    return powerSource;
}
public int getWheels()
{
    return wheels;
}
public int getPrice()
{
    return price;
}
```

- Enter the following set methods, which assign values to the `powerSource` and `wheels` fields.

```
public void setPowerSource(String source)
{
    powerSource = source;
}
public void setWheels(int wls)
{
    wheels = wls;
}
```

- The `setPrice()` method is an abstract method. Each subclass you eventually create that represents different vehicle types will have a unique prompt for the price and a different maximum allowed price. Type the abstract method definition and the closing curly brace for the class:

```
public abstract void setPrice();
}
```

- Save the file as **Vehicle.java**. At the command prompt, compile the file using the **javac** command.

## Extending an Abstract Class

You just created an abstract class, but you cannot instantiate any objects from this class. Rather, you must extend this class to be able to create any `Vehicle`-related objects. Next, you will create a `Sailboat` class that extends the `Vehicle` class. This new class is concrete; that is, you can create actual `Sailboat` class objects.

**To create the Sailboat class:**

1. Open a new file in your text editor, and then type the following, including a header for a Sailboat class that extends the Vehicle class:

```
import javax.swing.*;
public class Sailboat extends Vehicle
{
```

2. Add the declaration of a length field that is specific to a Sailboat by typing the following code:

```
private int length;
```

3. The Sailboat constructor must call its parent's constructor and send two arguments to provide values for the powerSource and wheels values. It also calls the setLength() method that prompts the user for and sets the length of the Sailboat objects:

```
public Sailboat()
{
    super("wind", 0);
    setLength();
}
```

4. Enter the following setLength() and getLength() methods, which respectively ask for and return the Sailboat's length:

```
public void setLength()
{
    String entry;
    entry = JOptionPane.showInputDialog
        (null, "Enter sailboat length in feet ");
    length = Integer.parseInt(entry);
}
public int getLength()
{
    return length;
}
```

5. The concrete Sailboat class must contain a setPrice() method because the method is abstract in the parent class. Assume that a Sailboat has a maximum price of \$100,000. Add the following setPrice() method that prompts the user for the price and forces it to the maximum value if the entered value is too high:

```
public void setPrice()
{
    String entry;
    final int MAX = 100000;
    entry = JOptionPane.showInputDialog
        (null, "Enter sailboat price ");
    price = Integer.parseInt(entry);
    if(price > MAX)
        price = MAX;
}
```

6. In Chapter 7, you first used the automatically included `Object` class `toString()` method that converts objects to `Strings`. Now, you can override that method for this class by writing your own version as follows. When you finish, add a closing curly brace for the class.

```
public String toString()
{
    return("The " + getLength() +
        " foot sailboat is powered by " +
        getPowerSource() + "; it has " + getWheels() +
        " wheels and costs $" + getPrice()); }
}
```

7. Save the file as `Sailboat.java`, and then compile the class.

## Extending an Abstract Class with a Second Subclass

The `Bicycle` class inherits from `Vehicle`, just as the `Sailboat` class does. Whereas the `Sailboat` class requires a data field to hold the length of the boat, the `Bicycle` class does not. Other differences lie in the content of the `setPrice()` and `toString()` methods.

### To create the `Bicycle` class file:

1. Open a new file in your text editor, and then type the following first lines of the `Bicycle` class:

```
import javax.swing.*;
public class Bicycle extends Vehicle
{
```

2. Enter the following `Bicycle` class constructor, which calls the parent constructor, sending it power source and wheel values:

```
public Bicycle()
{
    super("a person", 2);
}
```

3. Enter the following `setPrice()` method that forces a `Bicycle`'s price to be no greater than \$4,000:

```
public void setPrice()
{
    String entry;
    final int MAX = 4000;
    entry = JOptionPane.showInputDialog
        (null, "Enter bicycle price ");
    price = Integer.parseInt(entry);
    if(price > MAX)
        price = MAX;
}
```

4. Enter the following `toString()` method, and add the closing curly brace for the class:

```
public String toString()
{
    return("The bicycle is powered by " + getPowerSource() +
        "; it has " + getWheels() + " wheels and costs $" +
        getPrice()); }
}
```

5. Save the file as **Bicycle.java**, and then compile the class.

## Instantiating Objects from Subclasses

Next, you will create a program that instantiates concrete objects from each of the two child classes you just created.

### To create an application that demonstrates using the **Sailboat** and **Bicycle** classes:

1. Open a new file in your text editor, and then enter the start of the `DemoVehicles` class as follows:

```
import javax.swing.*;
public class DemoVehicles
{
    public static void main(String[] args)
    {
```

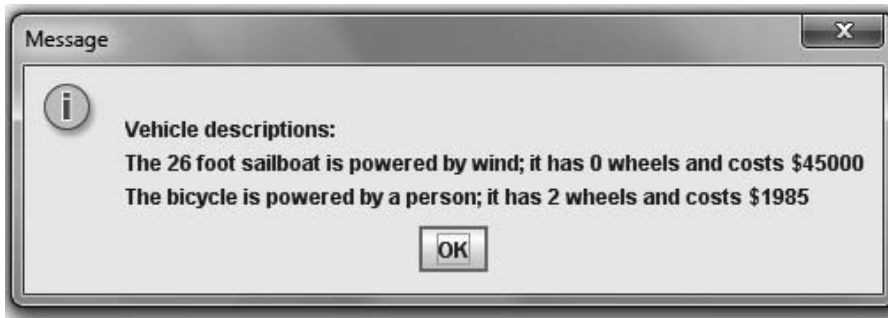
2. Enter the following statements that declare an object of each subclass type.

```
Sailboat aBoat = new Sailboat();
Bicycle aBike = new Bicycle();
```

3. Enter the following statement to display the contents of the two objects. Add the closing curly braces for the `main()` method and the class:

```
    JOptionPane.showMessageDialog(null,
        "\nVehicle descriptions:\n" +
        aBoat.toString() + "\n" + aBike.toString());
    }
}
```

4. Save the file as **DemoVehicles.java**, and then compile it. After you compile the class with no errors, run this application using the **java DemoVehicles** command. When the application prompts you, enter the length and price for a sailboat, and the price for a bicycle. Figure 11-30 shows output after typical user input.



**Figure 11-30** Typical output of the DemoVehicles application

## Using Object References

Next, you will write an application in which you create an array of `Vehicle` references. Within the application, you assign `Sailboat` objects and `Bicycle` objects to the same array. Then, because the different object types are stored in the same array, you can easily manipulate them by using a `for` loop.

### To write an application that uses a `Vehicle` array:

1. Open a new file in your text editor, and then enter the following first few lines of the `VehicleDatabase` program:

```
import javax.swing.*;
public class VehicleDatabase
{
    public static void main(String[] args)
    {
```

2. Create the following array of five `Vehicle` references and an integer subscript to use with the array:

```
Vehicle[] vehicles = new Vehicle[5];
int x;
```

3. Enter the following `for` loop that prompts you to select whether to enter a sailboat or a bicycle in the array. Based on user input, instantiate the appropriate object type.

```
for(x = 0; x < vehicles.length; ++x)
{
    String userEntry;
    int vehicleType;
    userEntry = JOptionPane.showInputDialog(null,
        "Please select the type of\n " +
        "vehicle you want to enter: \n1 - Sailboat\n" +
        " 2 - Bicycle");
    vehicleType = Integer.parseInt(userEntry);
    if(vehicleType == 1)
        vehicles[x] = new Sailboat();
    else
        vehicles[x] = new Bicycle();
}
```

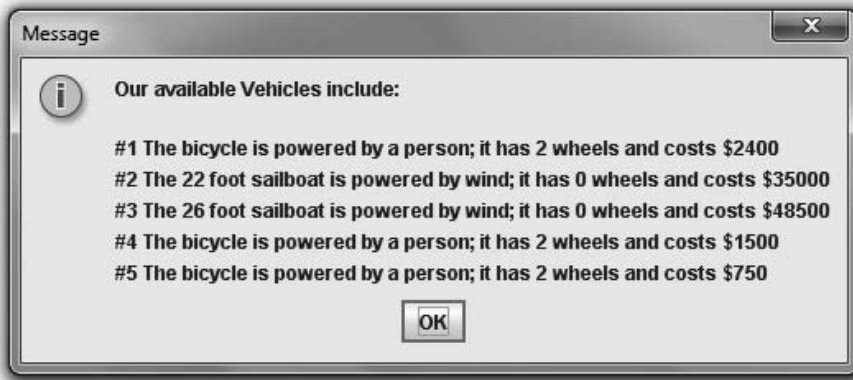
- After entering the information for each vehicle, display the array contents by typing the following code. First create a `StringBuffer` to hold the list of vehicles. Then, in a `for` loop, build an output `String` by repeatedly adding a newline character, a counter, and a vehicle from the array to the `StringBuffer` object. Display the constructed `StringBuffer` in a dialog box. Then type the closing curly braces for the `main()` method and the class:

```

StringBuffer outString = new StringBuffer();
for(x = 0; x < vehicles.length; ++x)
{
    outString.append("\n#" + (x + 1) + " ");
    outString.append(vehicles[x].toString());
}
OptionPane.showMessageDialog(null,
    "Our available Vehicles include:\n" +
    outString);
}
}
}

```

- Save the file as **VehicleDatabase.java**, and then compile it. Run the application, entering five objects of your choice. Figure 11-31 shows typical output after the user has entered data.



**Figure 11-31** Output of the VehicleDatabase application

## Using an Interface

In this section you will create an `Insured` interface for use with classes that represent objects that can be insured. For example, you might use this interface with classes such as `Jewelry` or `House`. You will extend `Vehicle` to create an `InsuredCar` class that implements the `Insured` interface, and then you will write a short program that instantiates an `InsuredCar` object.

### To create an `Insured` interface, the `InsuredCar` class, and a demonstration application:

- Open a new file in your text editor, and type the following `Insured` interface. A concrete class that implements `Insured` will be required to contain `setCoverage()` and `getCoverage()` methods.



```
public interface Insured
{
    public void setCoverage();
    public int getCoverage();
}
```

2. Save the file as **Insured.java** and compile it.
3. Open a new file in your text editor, and start the **InsuredCar** class that extends **Vehicle** and implements **Insured**:

```
import javax.swing.*;
public class InsuredCar extends Vehicle implements Insured
{
```

4. Add a variable to hold the amount covered by the insurance:
 

```
private int coverage;
```
5. Add a constructor that calls the **Vehicle** superclass constructor, passing arguments for the **InsuredCar**'s power source and number of wheels.

```
public InsuredCar()
{
    super("gas", 4);
    setCoverage();
}
```

6. Implement the **setPrice()** method required by the **Vehicle** class. The method accepts the car's price from the user and enforces a maximum value of \$60,000.

```
public void setPrice()
{
    String entry;
    final int MAX = 60000;
    entry = JOptionPane.showInputDialog
        (null, "Enter car price ");
    price = Integer.parseInt(entry);
    if(price > MAX)
        price = MAX;
}
```

7. Implement the **setCoverage()** and **getCoverage()** methods required by the **Insured** class. The **setCoverage()** method sets the coverage value for an insured car to 90 percent of the car's price:

```
public void setCoverage()
{
    coverage = (int)(price * 0.9);
}
public int getCoverage()
{
    return coverage;
}
```

8. Create a `toString()` method, followed by a closing brace for the class:

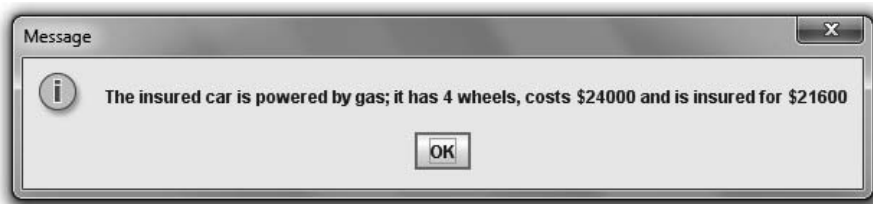
```
public String toString()
{
    return("The insured car is powered by " + getPowerSource() +
        "; it has " + getWheels() + " wheels, costs $" +
        getPrice() + " and is insured for $" + getCoverage());
}
```

9. Save the file as **InsuredCar.java** and compile it.

10. Create a demonstration program that instantiates an `InsuredCar` object and displays its values as follows:

```
import javax.swing.*;
public class InsuredCarDemo
{
    public static void main(String[] args)
    {
        InsuredCar myCar = new InsuredCar();
        JOptionPane.showMessageDialog(null,
            myCar.toString());
    }
}
```

11. Save the file as **InsuredCarDemo.java**. Compile and execute it. You will be prompted to enter the car's price. Figure 11-32 shows the output during a typical execution.



**Figure 11-32** Output of the `InsuredCarDemo` program

## Creating a Package

Next, you will place the `Vehicle` family of classes into a package. Assume you work for an organization that sponsors a Web site at *vehicleswesell.com*, so you will name the package `com.vehicleswesell`. First, you must create a folder named `VehiclePackage` in which to store your project. You can use any technique that is familiar to you. For example, in Windows, you can double-click Computer, navigate to the device or folder where you want to store the package, right-click, click New, click Folder, replace “New folder” with the new folder name (`VehiclePackage`), and press Enter. Alternatively, from the command prompt, you can navigate to the drive and folder where you want the new folder to reside by using the following commands:

- If the command prompt does not indicate the storage device you want, type the name of the drive and a colon to change the command prompt to a different device. For example, to change the command prompt to the F drive on your system, type `F:`.
- If the directory is not the one you want, type `cd\` to navigate to the root directory. The `cd` command stands for “change directory,” and the backslash indicates the root directory. Then type `cd` followed by the name of the subdirectory you want. You can repeat this command as many times as necessary to get to the correct subdirectory if it resides many levels down the directory hierarchy.

Next, you will place three classes into a package.

### To place classes into a package:

1. Open the **Vehicle.java** file in your text editor.
2. As the first line in the file, insert the following statement:  
**package com.vehicleswesell.vehicle;**
3. Save the file as **Vehicle.java** in the **VehiclePackage** folder.
4. At the command line, at the prompt for the VehiclePackage folder, compile the file using the following command:

```
javac -d . Vehicle.java
```

Be certain that you type a space between each element in the command, including surrounding the dot. Java creates a folder named `com\vehicleswesell\vehicle` within the directory from which you compiled the program, and the compiled **Vehicle.class** file is placed in this folder.



If you see a list of compile options when you try to compile the file, you did not type the spaces within the command correctly. Repeat Step 4 to compile again.

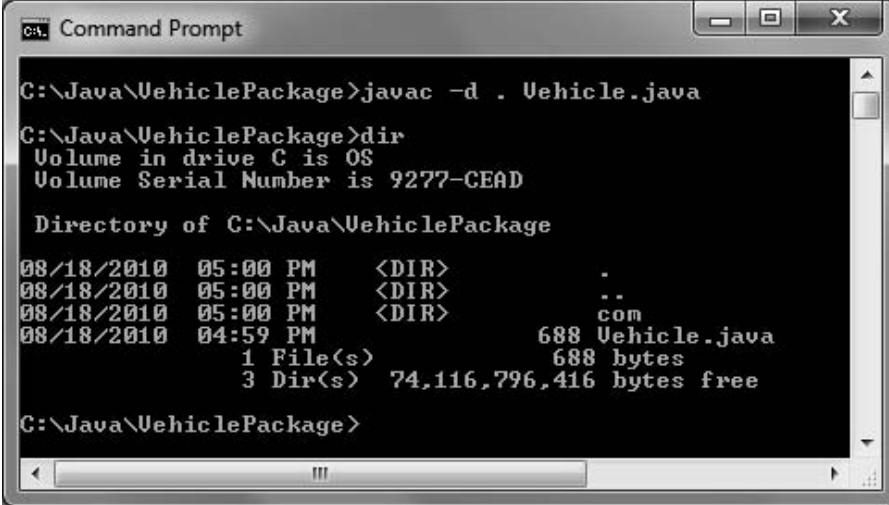


The development tool GRASP generates software visualizations to make programs easier to understand. A copy of this tool can be downloaded at <http://jgrasp.org>. If you are using jGRASP to compile your Java programs, you also can use it to set compiler options. To set a compiler option to `-d`, do the following:

- ♦ Open a jGRASP project workspace. Click the **Settings** menu, point to **Compiler Settings**, and then click **Workspace**. The Settings for workspace dialog box appears.
  - ♦ Under the **FLAGS** or **ARGS** section of the dialog box, click the dot inside the square next to the **Compile** option and enter the compiler option (`-d`). Then click the **Apply** button.
  - ♦ Click the **OK** button to close the dialog box, and then compile your program as usual.
5. Examine the folders on your storage device, using any operating system program with which you are familiar. For example, if you are compiling at the DOS command line, type **dir** at the command-line prompt to view the folders stored in the current directory. You can see that Java created a folder named `com`. (If you have too many files and folders stored, it might be difficult to locate the `com` folder. If so, type

**dir com\*.\*** to see all files and folders in the current folder that begin with “com”).

Figure 11-33 shows the command to compile the `Vehicle` class and the results of the `dir` command, including the `com` folder.



```
C:\Java\VehiclePackage>javac -d . Vehicle.java
C:\Java\VehiclePackage>dir
Volume in drive C is OS
Volume Serial Number is 9277-CEAD

Directory of C:\Java\VehiclePackage

08/18/2010  05:00 PM    <DIR>          .
08/18/2010  05:00 PM    <DIR>          ..
08/18/2010  05:00 PM    <DIR>          com
08/18/2010  04:59 PM                688 Vehicle.java
               1 File(s)                688 bytes
               3 Dir(s)  74,116,796,416 bytes free

C:\Java\VehiclePackage>
```

**Figure 11-33** Compiling the `Vehicle.java` file in a package and viewing the results

Alternatively, to view the created folders in a Windows operating system, you can double-click **Computer**, double-click the appropriate storage device, and locate the `com` folder. Within the `com` folder is a `vehicleswesell` folder, and within `vehicleswesell` is a `vehicle` folder. The **`Vehicle.class`** file is within the `vehicle` subfolder, and not in the same folder as the `.java` source file where it ordinarily would be placed.



If you cannot find the `com` folder on your storage device, you probably are not looking in the same folder where you compiled the class. Repeat Steps 4 and 5, but be certain that you first change to the command prompt for the directory where your source code file resides.

6. You could now delete the copy of the **`Vehicle.java`** file from the `VehiclePackage` folder (although you most likely want to retain a copy elsewhere). There is no further need for this source file in the folder you will distribute to users because the compiled `.class` file is stored in the `com\vehicleswesell\vehicle` folder. Don't delete the copy of your code from its original storage location; you might want to retain a copy of the code for modification later.
7. Open the **`Sailboat.java`** file in your text editor. For the first line in the file, insert the following statement:  
**`package com.vehicleswesell.vehicle;`**
8. Save the file in the same directory as you saved **`Vehicle.java`**. At the command line, compile the file using the following command:  
**`javac -d . Sailboat.java`**

Then you can delete the **Sailboat.java** source file from the `VehiclePackage` folder (not from its original location—you want to retain a copy of your original code).

9. Repeat Steps 7 and 8 to perform the same operations using the **Bicycle.java** file.
10. Open the **VehicleDatabase.java** file in your text editor. Insert the following statements at the top of the file:

```
import com.vehicleswesell.vehicle.Vehicle;  
import com.vehicleswesell.vehicle.Sailboat;  
import com.vehicleswesell.vehicle.Bicycle;
```

11. Save the file as **VehiclePackage\VehicleDatabase.java**. Compile the file, and then run the program. The program's output should be the same as it was before you added the import statements. Placing the `Vehicle`-related class files in a package is not required for the `VehicleDatabase` program to execute correctly; you ran it in exactly the same manner before you learned about creating packages.

Placing classes in packages gives you the ability to more easily isolate and distribute files.

## Don't Do It

- Don't write a body for an abstract method.
- Don't forget to end an abstract method header with a semicolon.
- Don't forget to override any abstract methods in any subclasses you derive.
- Don't mistakenly overload an abstract method instead of overriding it; the subclass method must have the same parameter list as the parent's abstract method.
- Don't try to instantiate an abstract class object.
- Don't forget to override all the methods in an interface that you implement.
- When you create your own packages, don't try to use the wildcard format to import multiple classes. This technique only works with built-in packages.

---

## Key Terms

**Concrete classes** are nonabstract classes from which objects can be instantiated.

An **abstract class** is one from which you cannot create any concrete objects, but from which you can inherit.

**Virtual classes** is the name given to abstract classes in other programming languages, such as C++.

An **abstract method** is declared with the keyword `abstract`. It is a method with no body—no curly braces and no method statements—just a return type, a method name, an optional

argument list, and a semicolon. You are required to code a subclass method to override the empty superclass method that is inherited.

**Dynamic method binding** is the ability of an application to select the correct subclass method when the program executes.

508

**Late method binding** is another term for dynamic method binding.

**Static** or **fixed method binding** is the opposite of dynamic method binding; it occurs when a subclass method is selected when the program compiles rather than while it is running.

**Ad-hoc polymorphism** occurs when a single method name can be used with a variety of data types because various implementations exist; it is another name for method overloading.

**Pure polymorphism** or **inclusion polymorphism** occurs when a single method implementation can be used with a variety of related objects because they are objects of subclasses of the parameter type.

The **Object class** is defined in the `java.lang` package, which is imported automatically every time you write a program; it includes methods that you can use or override. When you define a class, if you do not explicitly extend another class, your class is an extension of the `Object` class.

The `Object` class **`toString()` method** converts an `Object` into a `String` that contains information about the `Object`.

A **hash code** is a calculated number used to identify an object.

The `Object` class **`equals()` method** takes a single argument, which must be the same type as the type of the invoking object, and returns a `Boolean` value indicating whether two object references are equal.

**Multiple inheritance** is the capability to inherit from more than one class.

An **interface** looks much like a class, except that all of its methods must be abstract and all of its data (if any) must be `static final`; it declares method headers, but not the instructions within those methods.

A **Java ARchive (JAR) file** compresses the stored data.

A **default package** is the unnamed one in which a class is placed if you do not specify a package for the class.

**Collision** is a term that describes a class naming conflict.

## Chapter Summary

- A class that you create only to extend from, but not to instantiate from, is an abstract class. Usually, abstract classes contain abstract methods—methods with no method statements. You must code a subclass method to override any inherited abstract superclass method.
- When you create a superclass and one or more subclasses, each object of the subclass “is a” superclass object. Because every subclass object “is a” superclass member, you can

convert subclass objects to superclass objects. The ability of a program to select the correct subclass method is known as dynamic method binding.

- Dynamic method binding is most useful when you want to create a method that has one or more parameters that might be one of several types. You also can create an array of superclass object references but store subclass instances in it.
- Every class in Java is an extension of the `Object` class, whether or not you explicitly extend it. Every class inherits several methods from `Object`, including `toString()`, which converts an `Object` into a `String`, and `equals()`, which returns a `boolean` value indicating whether one object is a reference to another. You can override these methods to make them more useful for your classes.
- When you create a useful, extendable superclass, you save development time because much of the code needed for the class has already been written. In addition, you save testing time and, because the superclass code is reliable, you reduce the time it takes to learn the new class features. You also maintain superclass integrity.
- An interface is similar to a class, but all of its methods are implicitly `public` and `abstract`, and all of its data (if any) is implicitly `public`, `static`, and `final`. When you create a class that uses an interface, you include the keyword `implements` and the interface name in the class header. This notation serves to require class objects to include code for all the methods in the interface.
- Abstract classes and interfaces are similar in that you cannot instantiate concrete objects from either. Abstract classes differ from interfaces because abstract classes can contain nonabstract methods, but all methods within an interface must be abstract. A class can inherit from only one abstract superclass, but it can implement any number of interfaces.
- You can place classes in packages so you or other programmers can easily import related classes into new classes. The convention for naming packages uses Internet domain names in reverse order to ensure that your package names do not conflict with those of any other Internet users.

## Review Questions

1. Parent classes are \_\_\_\_\_ than their child classes.
  - a. less specific
  - b. more specific
  - c. easier to understand
  - d. more cryptic
2. Abstract classes differ from other classes in that you \_\_\_\_\_.
  - a. must not code any methods within them
  - b. must instantiate objects from them
  - c. cannot instantiate objects from them
  - d. cannot have data fields within them

3. Abstract classes can contain \_\_\_\_\_.
  - a. abstract methods
  - b. nonabstract methods
  - c. both of the above
  - d. none of the above
4. An abstract class `Product` has two subclasses, `Perishable` and `NonPerishable`. None of the constructors for these classes requires any arguments. Which of the following statements is legal?
  - a. `Product myProduct = new Product();`
  - b. `Perishable myProduct = new Product();`
  - c. `NonPerishable myProduct = new NonPerishable();`
  - d. none of the above
5. An abstract class `Employee` has two subclasses, `Permanent` and `Temporary`. The `Employee` class contains an abstract method named `setType()`. Before you can instantiate `Permanent` and `Temporary` objects, which of the following statements must be true?
  - a. You must code statements for the `setType()` method within the `Permanent` class.
  - b. You must code statements for the `setType()` method within both the `Permanent` and `Temporary` classes.
  - c. You must not code statements for the `setType()` method within either the `Permanent` or `Temporary` class.
  - d. You can code statements for the `setType()` method within the `Permanent` class or the `Temporary` class, but not both.
6. When you create a superclass and one or more subclasses, each object of the subclass \_\_\_\_\_ superclass object.
  - a. overrides the
  - b. "is a"
  - c. "is not a"
  - d. is a new
7. Which of the following statements is true?
  - a. Superclass objects are members of their subclass.
  - b. Superclasses can contain abstract methods.
  - c. You can create an abstract class object using the `new` operator.
  - d. An abstract class cannot contain an abstract method.
8. When you create a \_\_\_\_\_ in Java, you create a variable name in which you can hold the memory address of an object.
  - a. field
  - b. pointer
  - c. recommendation
  - d. reference



9. An application's ability to select the correct subclass method to execute is known as \_\_\_\_\_ method binding.
- a. polymorphic
  - b. dynamic
  - c. early
  - d. intelligent
10. Which statement creates an array of five references to an abstract class named `Currency`?
- a. `Currency[] = new Currency[5];`
  - b. `Currency[] currencyref = new Currency[5];`
  - c. `Currency[5] currencyref = new Currency[5];`
  - d. `Currency[5] = new Currency[5];`
11. You \_\_\_\_\_ override the `toString()` method in any class you create.
- a. cannot
  - b. can
  - c. must
  - d. must implement `StringListener` to
12. The `Object` class `equals()` method takes \_\_\_\_\_.
- a. no arguments
  - b. one argument
  - c. two arguments
  - d. as many arguments as you need
13. Assume the following statement appears in a working Java program:  
`if(thing.equals(anotherThing)) x = 1;`  
You know that \_\_\_\_\_.
- a. `thing` is an object of the `Object` class
  - b. `anotherThing` is the same type as `thing`
  - c. Both of the above are correct.
  - d. None of the above are correct.
14. The `Object` class `equals()` method considers two object references to be equal if they have the same \_\_\_\_\_.
- a. value in all data fields
  - b. value in any data field
  - c. data type
  - d. memory address
15. Java subclasses have the ability to inherit from \_\_\_\_\_ parent class(es).
- a. one
  - b. two
  - c. multiple
  - d. no
16. The alternative to multiple inheritance in Java is known as a(n) \_\_\_\_\_.
- a. superobject
  - b. abstract class
  - c. interface
  - d. none of the above

17. When you create a class that uses an interface, you include the keyword \_\_\_\_\_ and the interface's name in the class header.
- a. `interface`
  - b. `implements`
  - c. `accouterments`
  - d. `listener`
18. You can instantiate concrete objects from a(n) \_\_\_\_\_.
- a. abstract class
  - b. interface
  - c. either a or b
  - d. neither a nor b
19. In Java, a class can \_\_\_\_\_.
- a. inherit from one abstract super-class at most
  - b. implement one interface at most
  - c. both a and b
  - d. neither a nor b
20. When you want to provide some data or methods that subclasses can inherit, but you want the subclasses to override some specific methods, you should write a(n) \_\_\_\_\_.
- a. abstract class
  - b. interface
  - c. final superclass
  - d. concrete object

## Exercises

1. a. Create an abstract class named `Book`. Include a `String` field for the book's title and a `double` field for the book's price. Within the class, include a constructor that requires the book title, and add two get methods—one that returns the title and one that returns the price. Include an abstract method named `setPrice()`. Create two child classes of `Book`: `Fiction` and `NonFiction`. Each must include a `setPrice()` method that sets the price for all `Fiction` Books to \$24.99 and for all `NonFiction` Books to \$37.99. Write a constructor for each subclass, and include a call to `setPrice()` within each. Write an application demonstrating that you can create both a `Fiction` and a `NonFiction` Book, and display their fields. Save the files as **Book.java**, **Fiction.java**, **NonFiction.java**, and **UseBook.java**.
- b. Write an application named `BookArray` in which you create an array that holds 10 `Books`, some `Fiction` and some `NonFiction`. Using a for loop, display details about all 10 books. Save the file as **BookArray.java**.
2. a. Create an abstract class named `Account` for a bank. Include an integer field for the account number and a `double` field for the account balance. Also include a constructor that requires an account number and that sets the balance to 0.0. Include a set method for the balance. Also include two abstract get methods—one for each field. Create two child classes of `Account`: `Checking` and `Savings`. Within the `Checking` class, the get method displays the `String` "Checking Account Information", the account number, and the balance. Within the `Savings` class, add a field to hold the interest rate, and require the `Savings` constructor to accept an

- argument for the value of the interest rate. The `Savings` get method displays the `String` “Savings Account Information”, the account number, the balance, and the interest rate. Write an application that demonstrates you can instantiate and display both `Checking` and `Savings` objects. Save the files as **Account.java**, **Checking.java**, **Savings.java**, and **DemoAccounts.java**.
- b. Write an application named `AccountArray` in which you enter data for a mix of 10 `Checking` and `Savings` accounts. Use a `for` loop to display the data. Save the file as **AccountArray.java**.
3. Create an abstract `Auto` class with fields for the car make and price. Include `get` and `set` methods for these fields; the `setPrice()` method is abstract. Create two subclasses for individual automobile makers (for example, `Ford` or `Chevy`), and include appropriate `setPrice()` methods in each subclass (for example, \$20,000 or \$22,000). Finally, write an application that uses the `Auto` class and subclasses to display information about different cars. Save the files as **Auto.java**, **Ford.java**, **Chevy.java**, and **UseAuto.java**.
4. Create an abstract `Division` class with fields for a company’s division name and account number, and an abstract `display()` method. Use a constructor in the superclass that requires values for both fields. Create two subclasses named `InternationalDivision` and `DomesticDivision`. The `InternationalDivision` includes a field for the country in which the division is located and a field for the language spoken; its constructor requires both. The `DomesticDivision` includes a field for the state in which the division is located; a value for this field is required by the constructor. Write an application named `UseDivision` that creates `InternationalDivision` and `DomesticDivision` objects for two different companies and displays information about them. Save the files as **Division.java**, **InternationalDivision.java**, **DomesticDivision.java**, and **UseDivision.java**.
5. Write an application named `UseChildren` that creates and displays at least two `Child` objects—one `Male` and one `Female`. `Child` is an abstract class and `Male` and `Female` are subclasses. The `Child` class contains fields that hold the name, gender, and age of a child. The `Child` class constructor requires a name and a gender. The `Child` class also contains two abstract methods named `setAge()` and `display()`. The `Male` and `Female` subclass constructors require only a name; they pass the name and appropriate gender to the `Child`. The subclass constructors also prompt the user for an age using the `setAge()` method, and then display the `Child`’s data using the `display()` method. Save the files as **Child.java**, **Male.java**, **Female.java**, and **UseChildren.java**.
6. Create a class named `NewspaperSubscriber` with fields for a subscriber’s street address and the subscription rate. Include `get` and `set` methods for the subscriber’s street address, and include `get` and `set` methods for the subscription rate. The `set` method for the rate is abstract. Include an `equals()` method that indicates two `Subscribers` are equal if they have the same street address. Create child classes named `SevenDaySubscriber`, `WeekdaySubscriber`, and `WeekendSubscriber`. Each child class constructor sets the rate as follows: `SevenDaySubscribers` pay \$4.50

per week, `WeekdaySubscribers` pay \$3.50 per week, and `WeekendSubscribers` pay \$2.00 per week. Each child class should include a `toString()` method that returns the street address, rate, and service type. Write an application named `Subscribers` that prompts the user for the subscriber's street address and requested service, and then creates the appropriate object based on the service type. Do not let the user enter more than one subscription type for any given street address. Save the files as **`NewspaperSubscriber.java`**, **`WeekdaySubscriber.java`**, **`WeekendSubscriber.java`**, **`SevenDaySubscriber.java`**, and **`Subscribers.java`**.

7. a. Create an interface named `Turner`, with a single method named `turn()`. Create a class named `Leaf` that implements `turn()` to display "Changing colors". Create a class named `Page` that implements `turn()` to display "Going to the next page". Create a class named `Pancake` that implements `turn()` to display "Flipping". Write an application named `DemoTurners` that creates one object of each of these class types and demonstrates the `turn()` method for each class. Save the files as **`Turner.java`**, **`Leaf.java`**, **`Page.java`**, **`Pancake.java`**, and **`DemoTurners.java`**.  
b. Think of two more objects that use `turn()`, create classes for them, and then add objects to the `DemoTurners` application, renaming it **`DemoTurners2.java`**. Save the files, using the names of new objects that use `turn()`.
8. Write an application named `UseInsurance` that uses an abstract `Insurance` class and `Health` and `Life` subclasses to display different types of insurance policies and the cost per month. The `Insurance` class contains a `String` representing the type of insurance and a `double` that holds the monthly price. The `Insurance` class constructor requires a `String` argument indicating the type of insurance, but the `Life` and `Health` class constructors require no arguments. The `Insurance` class contains a `get` method for each field; it also contains two abstract methods named `setCost()` and `display()`. The `Life` class `setCost()` method sets the monthly fee to \$36, and the `Health` class sets the monthly fee to \$196. Write an application named `UseInsurance` that prompts the user for the type of insurance to be displayed, and then create the appropriate object. Save the files as **`Life.java`**, **`Health.java`**, **`Insurance.java`**, and **`UseInsurance.java`**.
9. Write an application named `UseLoan` that uses an abstract class named `PersonalLoan` and subclasses to display two different types of loans—home and car—and the cost per month for each. Each of the subclasses contains a constructor that sets the cost per month based on the loan type, after prompting the user for at least one data-entry item that is used in the cost-determining decision. (For example, with a car loan, you might ask the age of the car, or whether it is a sports car.) Include an abstract `toString()` method in the `PersonalLoan` class that constructs a `String` containing all the relevant data. Prompt the user for the type of loan, and then create and display the appropriate object. Save the files as **`PersonalLoan.java`**, **`CarLoan.java`**, **`HomeLoan.java`**, and **`UseLoan.java`**.
10. Create an abstract class called `GeometricFigure`. Each figure includes a height, a width, a figure type, and an area. Include an abstract method to determine the area of the figure. Create two subclasses called `Square` and `Triangle`. Create an application that demonstrates creating objects of both subclasses, and store them in an array. Save the files as **`GeometricFigure.java`**, **`Square.java`**, **`Triangle.java`**, and **`UseGeometric.java`**.

11. Modify Exercise 10, adding an interface called `SidedObject` that contains a method called `displaySides()`; this method displays the number of sides the object possesses. Modify the `GeometricFigure` subclasses to include the use of the interface to display the number of sides of the figure. Create an application that demonstrates the use of both subclasses. Save the files as **`GeometricFigure2.java`**, **`Square2.java`**, **`Triangle2.java`**, **`SidedObject.java`**, and **`UseGeometric2.java`**.
12. Create an interface called `Player`. The interface has an abstract method called `play()` that displays a message describing the meaning of “play” to the class. Create classes called `Child`, `Musician`, and `Actor` that all implement `Player`. Create an application that demonstrates the use of the classes. Save the files as **`Player.java`**, **`Child.java`**, **`Actor.java`**, **`Musician.java`**, and **`UsePlayer.java`**.
13. Create an abstract class called `Student`. The `Student` class includes a name and a Boolean value representing full-time status. Include an abstract method to determine the tuition, with full-time students paying a flat fee of \$2,000 and part-time students paying \$200 per credit hour. Create two subclasses called `FullTime` and `PartTime`. Create an application that demonstrates how to create objects of both subclasses. Save the files as **`Student.java`**, **`FullTime.java`**, **`PartTime.java`**, and **`UseStudent.java`**.
14. Create a `Building` class and two subclasses, `House` and `School`. The `Building` class contains fields for square footage and stories. The `House` class contains additional fields for number of bedrooms and baths. The `School` class contains additional fields for number of classrooms and grade level (for example, elementary or junior high). All the classes contain appropriate get and set methods. Place the `Building`, `House`, and `School` classes in a package named `com.course.buildings`. Create an application that declares objects of each type and uses the package. Save the necessary files as **`Building.java`**, **`House.java`**, **`School.java`**, and **`CreateBuildings.java`**.
15. Sanchez Construction Loan Co. makes loans of up to \$100,000 for construction projects. There are two categories of Loans—those to businesses and those to individual applicants.

Write an application that tracks all new construction loans. The application must also calculate the total amount owed at the due date (original loan amount + loan fee). The application should include the following classes:

- ♦ `Loan`—A public abstract class that implements the `LoanConstants` interface. A `Loan` includes a loan number, customer last name, amount of loan, interest rate, and term. The constructor requires data for each of the fields except interest rate. Do not allow loan amounts over \$100,000. Force any loan term that is not one of the three defined in the `LoanConstants` class to a short-term, one-year loan. Create a `toString()` method that displays all the loan data.
- ♦ `LoanConstants`—A public interface class. `LoanConstants` includes constant values for short-term (1 year), medium-term (3 years), and long-term (5 years) loans. It also contains constants for the company name and the maximum loan amount.

- **BusinessLoan**—A public class that extends **Loan**. The **BusinessLoan** constructor sets the interest rate to 1% over the current prime interest rate.
- **PersonalLoan**—A public class that extends **Loan**. The **PersonalLoan** constructor sets the interest rate to 2% over the current prime interest rate.
- **CreateLoans**—An application that creates an array of five **Loans**. Prompt the user for the current prime interest rate. Then, in a loop, prompt the user for a loan type and all relevant information for that loan. Store the created **Loan** objects in the array. When data entry is complete, display all the loans.

Save the files as **Loan.java**, **LoanConstants.java**, **BusinessLoan.java**, **PersonalLoan.java**, and **CreateLoans.java**.



## Debugging Exercise

16. Each of the following files in the Chapter.11 folder of your downloadable student files has syntax and/or logic errors. In each case, determine the problem and fix the program. After you correct the errors, save each file using the same filename preceded with **Fix**. For example, **DebugEleven1.java** will become **FixDebugEleven1.java**.
  - a. **DebugEleven1.java**
  - b. **DebugEleven2.java**
  - c. **DebugEleven3.java**
  - d. **DebugEleven4.java**

The folder also contains three other **Debug** files.



## Game Zone

17. In Chapter 10, you created an **Alien** class as well as two descendant classes, **Martian** and **Jupiterian**. Because you never create any “plain” **Alien** objects, alter the **Alien** class so it is abstract. Verify that the **Martian** and **Jupiterian** classes can still inherit from **Alien** and that the **CreateAliens** program still works correctly. Save the altered **Alien** file as **Alien.java**.
18. a. Create an abstract **CardGame** class similar to the one described in this chapter. The class contains a “deck” of 52 playing cards that uses a **Card** class that holds a suit and value for each **Card** object. It also contains an integer field that holds the number of cards dealt to a player in a particular game. The class contains a constructor that initializes the deck of cards with appropriate values (e.g., “King of Hearts”), and a **shuffle()** method that randomly arranges the positions of the **Cards** in the array. The class also contains two abstract methods: **displayDescription()**, which displays a brief description of the game in each of the child classes, and **deal()**, which deals the appropriate number of **Card** objects to one player of a game. Save the file as **CardGame.java**.

- b. Create two child classes that extend `CardGame`. You can choose any games you prefer. For example, you might create a `Poker` class or a `Bridge` class. Create a constructor for each child class that initializes the field that holds the number of cards dealt to the correct value. (For example, in standard poker, a player receives five cards, but in bridge, a player receives 13.) Create an appropriate `displayDescription()` and `deal()` method for each child class. Save each file using an appropriate name—for example, **`Poker.java`** or **`Bridge.java`**.
- c. Create an application that instantiates one object of each game type and demonstrates that the methods work correctly. Save the application as **`PlayCardGames.java`**.

*This page intentionally left blank*



# Exception Handling

In this chapter, you will:

- ① Learn about exceptions
- ① Try code and catch Exceptions
- ① Throw and catch multiple Exceptions
- ① Use the `finally` block
- ① Understand the advantages of exception handling
- ① Specify the Exceptions a method can throw
- ① Trace Exceptions through the call stack
- ① Create your own Exceptions
- ① Use an assertion

## Learning About Exceptions

An **exception** is an unexpected or error condition. The programs you write can generate many types of potential exceptions, such as when you do the following:

- You issue a command to read a file from a disk, but the file does not exist there.
- You attempt to write data to a disk, but the disk is full or unformatted.
- Your program asks for user input, but the user enters invalid data.
- The program attempts to divide a value by 0.
- The program tries to access an array with a subscript that is too large or too small.

These errors are called exceptions because, presumably, they are not usual occurrences; they are “exceptional.” **Exception handling** is the name for the object-oriented techniques to manage such errors. Unplanned exceptions that occur during a program’s execution are also called **runtime exceptions**.

Java has two basic classes of errors: `Error` and `Exception`. Both of these classes descend from the `Throwable` class, as shown in Figure 12-1. Like instantiations of all other classes in Java, exceptions originally descend from `Object`.



Java acknowledges more than 75 categories of `Exceptions` with unusual names such as `ActivationException`, `AlreadyBoundException`, `AWTException`, `CloneNotSupportedException`, `PropertyVetoException`, and `UnsupportedFlavorException`. See <http://java.sun.com> for more details about these and other `Exceptions`.

The **Error class** represents more serious errors from which your program usually cannot recover. Usually, you do not use or implement `Error` objects in your programs. A program cannot recover from `Error` conditions on its own.

The **Exception class** comprises less serious errors that represent unusual conditions that arise while a program is running and from which the program *can* recover. Some examples of `Exception` class errors include using an invalid array subscript or performing certain illegal arithmetic operations.

Java displays an `Exception` message when the program code could have prevented an error. For example, Figure 12-2 shows a class named `Division` that contains a single, small `main()` method. The method declares three integers, prompts the user for values for two of them, and calculates the value of the third integer by dividing the first two values.

```

java.lang.Object
|
+--java.lang.Throwable
|
+--java.lang.Exception
|
+--java.io.IOException
|
+--java.lang.RuntimeException
|
+--java.lang.ArithmeticException
|
+-- java.lang.IndexOutOfBoundsException
|
+--java.lang.ArrayIndexOutOfBoundsException
|
+-- java.util.NoSuchElementException
|
+--java.util.InputMismatchException
|
+--Others..
|
+--Others..
|
+--java.lang.Error
|
+-- java.lang.VirtualMachineError
|
+--java.lang.OutOfMemoryError
|
+--java.lang.InternalError
|
+--Others...

```

**Figure 12-1** The Exception and Error class inheritance hierarchy

```

import java.util.Scanner;
public class Division
{
    public static void main(String[] args)
    {
        Scanner input = new Scanner(System.in);
        int numerator, denominator, result;
        System.out.print("Enter numerator >> ");
        numerator = input.nextInt();
        System.out.print("Enter denominator >> ");
        denominator = input.nextInt();
    }
}

```

**Figure 12-2** The Division class (*continues*)

(continued)

```
        result = numerator / denominator;
        System.out.println(numerator + " / " + denominator +
            " = " + result);
    }
}
```

522

**Figure 12-2** The `Division` class

Figure 12-3 shows two typical executions of the `Division` program. In the first execution, the user enters two usable values and the program executes normally. In the second execution, the user enters 0 as the value for the denominator and an `Exception` message is displayed. (Java does not allow integer division by 0, but floating-point division by 0 is allowed—the result displays as `Infinity`.)



```
Command Prompt
C:\Java>java Division
Enter numerator >> 12
Enter denominator >> 4
12 / 4 = 3

C:\Java>java Division
Enter numerator >> 12
Enter denominator >> 0
Exception in thread "main" java.lang.ArithmeticException: / by zero
    at Division.main(Division.java:12)

C:\Java>_
```

**Figure 12-3** Two typical executions of the `Division` application

In Figure 12-3, the `Exception` is a `java.lang.ArithmeticException`. `ArithmeticException` is one of many subclasses of `Exception`. You also get some information about the error (“/ by zero”), the method that generated the error (`Division.main`), and the file and line number for the error (`Division.java`, line 12).

Figure 12-4 shows two more executions of the `Division` class. In each execution, the user has entered noninteger data for the denominator—first a string of characters, and second, a floating-point value. In each case, a different type of `Exception` occurs. You can see from either set of error messages that the `Exception` is an `InputMismatchException`. The last line of the messages indicates that the problem occurred in line 11 of the `Division` program, and the second-to-last error message shows that the problem occurred within the call to `nextInt()`. Because the user did not enter an integer, the `nextInt()` method failed. The second-to-last message also shows that the error occurred in line 2050 of the `nextInt()` method, but clearly you do not want to alter the `nextInt()` method that resides in the `Scanner` class—you either want to rerun the program and enter an integer, or alter the program so that these errors cannot occur in subsequent executions.

```

C:\Java>java Division
Enter numerator >> 12
Enter denominator >> three
Exception in thread "main" java.util.InputMismatchException
    at java.util.Scanner.throwFor(Scanner.java:840)
    at java.util.Scanner.next(Scanner.java:1461)
    at java.util.Scanner.nextInt(Scanner.java:2091)
    at java.util.Scanner.nextInt(Scanner.java:2050)
    at Division.main(Division.java:11)

C:\Java>java Division
Enter numerator >> 12
Enter denominator >> 3.0
Exception in thread "main" java.util.InputMismatchException
    at java.util.Scanner.throwFor(Scanner.java:840)
    at java.util.Scanner.next(Scanner.java:1461)
    at java.util.Scanner.nextInt(Scanner.java:2091)
    at java.util.Scanner.nextInt(Scanner.java:2050)
    at Division.main(Division.java:11)

C:\Java>

```

**Figure 12-4** Two executions of the `Division` application in which the user enters noninteger values

The list of error messages after each attempted execution in Figure 12-4 is called a **stack trace history list**, or more simply, a **stack trace**. (You might also hear the terms *stack backtrack* or *stack traceback*.) The list shows each method that was called as the program ran. You will learn more about tracing the stack later in this chapter.

Just because an `Exception` occurs, you don't necessarily have to deal with it. In the `Division` class, you can simply let the offending program terminate as it did in Figure 12-4. However, the program termination is abrupt and unforgiving. When a program divides two numbers (or performs a less trivial task such as balancing a checkbook), the user might be annoyed if the program ends abruptly. However, if the program is used for a mission critical task such as air-traffic control or to monitor a patient's vital statistics during surgery, an abrupt conclusion could be disastrous. (The term **mission critical** refers to any process that is crucial to an organization.) Object-oriented error-handling techniques provide more elegant and safer solutions for errors.

Of course, you can write programs without using exception-handling techniques—you have already written many such programs as you have worked through this book. Programmers had to deal with error conditions long before object-oriented methods were conceived. Probably the most common error-handling solution has been to use a decision to avoid an error. For example, you can change the `main()` method of the `Division` class to avoid dividing by 0 by adding the decision shown in the shaded portion of Figure 12-5.

```

import java.util.Scanner;
public class Division2
{
    public static void main(String[] args)
    {
        Scanner input = new Scanner(System.in);
        int numerator, denominator, result;

```

**Figure 12-5** A `Division2` application using a traditional error-handling technique (continues)

(continued)

```
System.out.print("Enter numerator >> ");
numerator = input.nextInt();
System.out.print("Enter denominator >> ");
denominator = input.nextInt();
if(denominator == 0)
    System.out.println("Cannot divide by 0");
else
{
    result = numerator / denominator;
    System.out.println(numerator + " / " + denominator +
        " = " + result);
}
}
```

**Figure 12-5** A Division2 application using a traditional error-handling technique

The application in Figure 12-5 displays a message to the user when 0 is entered for a denominator value, but it is not able to recover when noninteger data such as a string or floating-point value is entered. Object-oriented exception handling provides a more elegant solution for handling error conditions.

Programs that can handle exceptions appropriately are said to be more fault tolerant and robust. **Fault-tolerant** applications are designed so that they continue to operate, possibly at a reduced level, when some part of the system fails. **Robustness** represents the degree to which a system is resilient to stress, maintaining correct functioning.

Even if you choose never to use exception-handling techniques in your own programs, you must understand them because built-in Java methods will throw exceptions to your programs.

## TWO TRUTHS & A LIE

### Learning About Exceptions

1. Exception handling is the name for the object-oriented techniques used to manage runtime errors.
2. The `Error` class represents serious errors from which your program usually cannot recover; the `Exception` class comprises less serious errors that represent unusual conditions while a program is running and from which the program *can* recover.
3. When an `Exception` occurs, your program must handle it using object-oriented exception-handling techniques.

The false statement is #3. Just because an `Exception` occurs, you don't necessarily have to deal with it. You have already written many programs that do not handle exceptions that arise.

## Trying Code and Catching Exceptions

In object-oriented terminology, you “try” a procedure that might cause an error. A method that detects an error condition or `Exception` “throws an exception,” and the block of code that processes the error “catches the exception.”

When you create a segment of code in which something might go wrong, you place the code in a **try block**, which is a block of code you attempt to execute while acknowledging that an exception might occur. A try block consists of the following elements:

- The keyword `try`
- An opening curly brace
- Executable statements, including some that might cause exceptions
- A closing curly brace

You usually code at least one `catch` block immediately following a `try` block. A **catch block** is a segment of code that can handle an exception that might be thrown by the `try` block that precedes it. The exception might be one that is thrown automatically, or you might explicitly write a `throw` statement. A **throw statement** is one that sends an `Exception` out of a block or a method so it can be handled elsewhere. A thrown `Exception` can be caught by a `catch` block. Each `catch` block can “catch” one type of exception—that is, one object that is an object of type `Exception` or one of its child classes. You create a `catch` block by typing the following elements:

- The keyword `catch`
- An opening parenthesis
- An `Exception` type
- A name for an instance of the `Exception` type
- A closing parenthesis
- An opening curly brace
- The statements that take the action you want to use to handle the error condition
- A closing curly brace



If you do not include a `catch` block immediately after a `try` block, then you must code a `finally` block. You will learn about `finally` blocks later in this chapter.

Figure 12-6 shows the general format of a method that includes a shaded `try...catch` pair. A `catch` block looks a lot like a method named `catch()` that takes an argument that is some type of `Exception`. However, it is not a method; it has no return type, and you can't call it directly. Some programmers refer to a `catch` block as a *catch clause*.

```

returnType methodName(optional arguments)
{
    // optional statements prior to code that is tried
    try
    {
        // statement or statements that might generate an exception
    }
    catch(Exception someException)
    {
        // actions to take if exception occurs
    }
    // optional statements that occur after try,
    // whether catch block executes or not
}

```

**Figure 12-6** Format of try...catch pair

In Figure 12-6, `someException` represents an object of the `Exception` class or any of its subclasses. If an `Exception` occurs during the execution of the `try` block, the statements in the `catch` block execute. If no `Exception` occurs within the `try` block, the `catch` block does not execute. Either way, the statements following the `catch` block execute normally.

Figure 12-7 shows an application named `DivisionMistakeCaught` that improves on the `Division` class. The `main()` method in the class contains a `try` block with code that attempts division. When illegal integer division is attempted, an `ArithmeticException` is automatically created and the `catch` block executes. Figure 12-8 shows two typical executions, one with an `Exception` and one without.

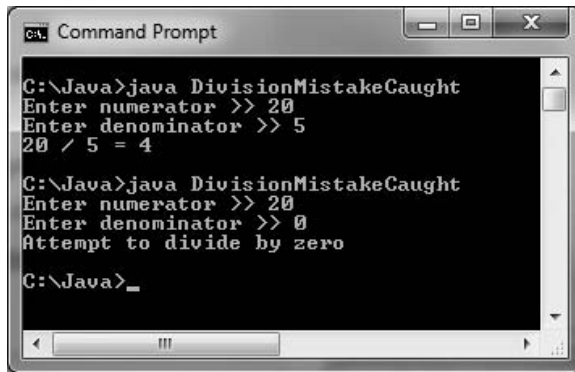
```

import java.util.Scanner;
public class DivisionMistakeCaught
{
    public static void main(String[] args)
    {
        Scanner input = new Scanner(System.in);
        int numerator, denominator, result;
        System.out.print("Enter numerator >> ");
        numerator = input.nextInt();
        System.out.print("Enter denominator >> ");
        denominator = input.nextInt();
        try
        {
            result = numerator / denominator;
            System.out.println(numerator + " / " + denominator +
                " = " + result);
        }
        catch(ArithmeticException mistake)
        {
            System.out.println("Attempt to divide by zero");
        }
    }
}

```

**Figure 12-7** The `DivisionMistakeCaught` application





```

C:\Java>java DivisionMistakeCaught
Enter numerator >> 20
Enter denominator >> 5
20 / 5 = 4

C:\Java>java DivisionMistakeCaught
Enter numerator >> 20
Enter denominator >> 0
Attempt to divide by zero

C:\Java>_

```

**Figure 12-8** Output of the `DivisionMistakeCaught` application



In the application in Figure 12-7, the `throw` and `catch` operations reside in the same method. Later in this chapter, you will learn that `throws` and their corresponding `catch` blocks frequently reside in separate methods.



If you want to send error messages to a different location from “normal” output, you can use `System.err` instead of `System.out`. For example, if an application writes a report to a specific disk file, you might want errors to write to a different location—perhaps to a different disk file or to the screen.

Although the `DivisionMistakeCaught` application displays the error message (“Attempt to divide by zero”), you cannot be sure that division by 0 was the source of the error. In reality, *any* `ArithmeticException` generated within the `try` block in the program would be caught by the `catch` block in the method. Instead of writing your own message, you can use the `getMessage()` method that `ArithmeticException` inherits from the `Throwable` class. To retrieve Java’s message about any `ThrowableException` named `someException`, you code `someException.getMessage()`.



As an example of another condition that could generate an `ArithmeticException`, if you create an object using Java’s `BigDecimal` class and then perform a division that results in a nonterminating decimal division such as  $1/3$ , but specify that an exact result is needed, an `ArithmeticException` is thrown. As another example, you could create your own class containing a method that creates a new instance of the `ArithmeticException` class and throws it under any conditions you specify.

For example, Figure 12-9 shows a `DivisionMistakeCaught2` class that uses the `getMessage()` method (see the shaded statement) to generate the message that “comes with” the caught `ArithmeticException` argument to the `catch` block. Figure 12-10 shows the output; the message is “/ by zero”.

```
import java.util.Scanner;
public class DivisionMistakeCaught2
{
    public static void main(String[] args)
    {
        Scanner input = new Scanner(System.in);
        int numerator, denominator, result;
        System.out.print("Enter numerator >> ");
        numerator = input.nextInt();
        System.out.print("Enter denominator >> ");
        denominator = input.nextInt();
        try
        {
            result = numerator / denominator;
            System.out.println(numerator + " / " + denominator +
                " = " + result);
        }
        catch(ArithmeticException mistake)
        {
            System.out.println(mistake.getMessage());
        }
    }
}
```

Figure 12-9 The DivisionMistakeCaught2 application

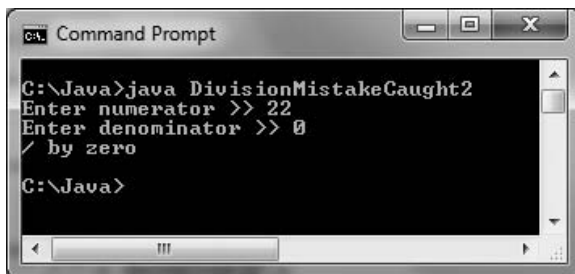


Figure 12-10 Output of the DivisionMistakeCaught2 application

It should be no surprise that the automatically generated error message in Figure 12-10 is “/ by zero”; you saw the same message in Figure 12-3 when the programmer provided no exception handling, the exception was automatically thrown, and its message was automatically supplied.

Of course, you might want to do more in a catch block than display an error message; after all, Java did that for you without requiring you to write the code to catch any Exceptions. You also might want to add code to correct the error; for example, such code could force the

arithmetic to divide by 1 rather than by 0. Figure 12-11 shows `try...catch` code in which the catch block computes the result by dividing by 1 instead of by the `denominator` value. After the catch block, the application could continue with a guarantee that `result` holds a valid value—either the division worked in the `try` block and the catch block did not execute, or the catch block remedied the error.

```
try
{
    result = numerator / denominator;
}
catch(ArithmeticException mistake)
{
    result = numerator / 1;
}
// program continues here; result is guaranteed to have a valid value
```

**Figure 12-11** A `try...catch` block in which the catch block corrects the error



In the code in Figure 12-11, you can achieve the same result in the `catch` block by coding `result = numerator;` instead of `result = numerator / 1;`. Explicitly dividing by 1 simply makes the code's intention clearer, but it does require a small amount of time to execute the instruction. As an alternative, you could make the program more efficient by omitting the division by 1 and adding clarity with a comment.



Watch the video *Exceptions*.

## TWO TRUTHS & A LIE

### Trying Code and Catching Exceptions

1. A `try` block is a block of code you attempt to execute while acknowledging that an exception might occur.
2. You usually code at least one `catch` block immediately following a `try` block to handle an exception that might be thrown by the `try` block.
3. A `throw` statement is one that sends an `Exception` to a `try` block so it can be handled.

The false statement is #3. A `throw` statement sends an `Exception` to a `catch` block.

## Throwing and Catching Multiple Exceptions

You can place as many statements as you need within a try block, and you can catch as many Exceptions as you want. If you try more than one statement, only the first error-generating statement throws an Exception. As soon as the Exception occurs, the logic transfers to the catch block, which leaves the rest of the statements in the try block unexecuted.

When a program contains multiple catch blocks, they are examined in sequence until a match is found for the type of Exception that occurred. Then, the matching catch block executes, and each remaining catch block is bypassed.

For example, consider the application in Figure 12-12. The main() method in the DivisionMistakeCaught3 class throws two types of Exceptions: an ArithmeticException and an InputMismatchException. The try block in the application surrounds all the statements in which the exceptions might occur.

```
import java.util.*;
public class DivisionMistakeCaught3
{
    public static void main(String[] args)
    {
        Scanner input = new Scanner(System.in);
        int numerator, denominator, result;
        try
        {
            System.out.print("Enter numerator >> ");
            numerator = input.nextInt();
            System.out.print("Enter denominator >> ");
            denominator = input.nextInt();
            result = numerator / denominator;
            System.out.println(numerator + " / " + denominator +
                " = " + result);
        }
        catch(ArithmeticException mistake)
        {
            System.out.println(mistake.getMessage());
        }
        catch(InputMismatchException mistake)
        {
            System.out.println("Wrong data type");
        }
    }
}
```

**Figure 12-12** The DivisionMistakeCaught3 class



The program in Figure 12-12 must import the `java.util.InputMismatchException` class to be able to use an `InputMismatchException` object. The `java.util` package is also needed for the `Scanner` class, so it's easiest to import the whole package.



If you use the `getMessage()` method with the `InputMismatchException` object, you see that the message is `null`, because `null` is the default message value for an `InputMismatchException` object.

In the `main()` method of the program in Figure 12-12, the `try` block executes. Several outcomes are possible:

- If the user enters two usable integers, `result` is calculated, normal output is displayed, and neither catch block executes.
- If the user enters an invalid (noninteger) value at either the first or second shaded statement, an `InputMismatchException` object is created and thrown. When the program encounters the first catch block (that catches an `ArithmeticException`), the block is bypassed because the `Exception` types do not match. When the program encounters the second catch block, the types match, and the “Wrong data type” message is displayed.
- If the user enters 0 for denominator, the division statement throws an `ArithmeticException`, and the `try` block is abandoned. When the program encounters the first catch block, the `Exception` types match, the value of the `getMessage()` method is displayed, and then the second catch block is bypassed.

Figure 12-13 shows the output of four typical program executions.

When you list multiple catch blocks following a `try` block, you must be careful that some catch blocks don’t become unreachable. Unreachable statements are program statements that can never execute under any circumstances. For example, if two successive catch blocks catch an `ArithmeticException` and an ordinary `Exception`, respectively, the `ArithmeticException` errors cause the first catch to execute and other `Exceptions` “fall through” to the more general `Exception` catch block. However, if you reverse the sequence of the catch blocks so that the one that catches general `Exception` objects is first, even

`ArithmeticExceptions` would be caught by the `Exception` catch. The `ArithmeticException` catch block therefore is unreachable because the `Exception` catch block is in its way, and the class does not compile. Think of arranging your catch blocks so that the “bigger basket” is always below a smaller

```

C:\Java>java DivisionMistakeCaught3
Enter numerator >> 35
Enter denominator >> 5
35 / 5 = 7

C:\Java>java DivisionMistakeCaught3
Enter numerator >> six
Wrong data type

C:\Java>java DivisionMistakeCaught3
Enter numerator >> 6
Enter denominator >> two
Wrong data type

C:\Java>java DivisionMistakeCaught3
Enter numerator >> 13
Enter denominator >> 0
/ by zero

C:\Java>_
    
```

**Figure 12-13** Four executions of the `DivisionMistakeCaught3` application

one. That is, each `Exception` should “fall through” as many catch blocks as necessary to reach the one that will hold it.



You first learned about unreachable statements in Chapter 3. For example, statements that follow a method's `return` statement are unreachable. Creating an unreachable `catch` block causes a compiler error that generates a message indicating that the exception “has already been caught.”

532

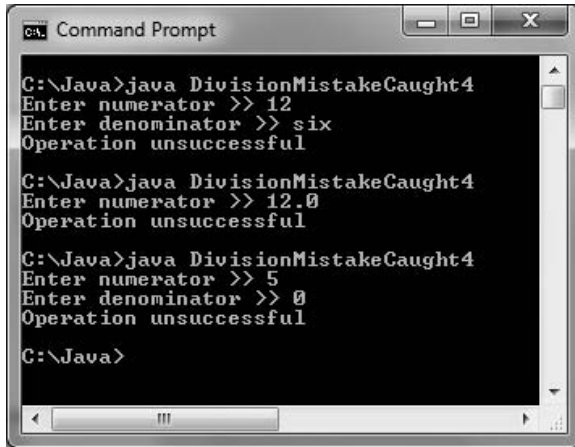
Sometimes, you want to execute the same code no matter which `Exception` type occurs. For example, within the `DivisionMistakeCaught3` application in Figure 12-12, each of the two catch blocks displays a unique message. Instead, you might want both catch blocks to display the same message. Because `ArithmeticExceptions` and `InputMismatchExceptions` are both subclasses of `Exception`, you can rewrite the program as shown in Figure 12-14, using a single generic catch block (shaded) that can catch any type of `Exception`.

```
import java.util.*;
public class DivisionMistakeCaught4
{
    public static void main(String[] args)
    {
        Scanner input = new Scanner(System.in);
        int numerator, denominator, result;
        try
        {
            System.out.print("Enter numerator >> ");
            numerator = input.nextInt();
            System.out.print("Enter denominator >> ");
            denominator = input.nextInt();
            result = numerator / denominator;
            System.out.println(numerator + " / " + denominator +
                " = " + result);
        }
        catch(Exception mistake)
        {
            System.out.println("Operation unsuccessful");
        }
    }
}
```

**Figure 12-14** The `DivisionMistakeCaught4` application

The catch block in Figure 12-14 accepts a more generic `Exception` argument type than that thrown by either of the potentially error-causing try statements, so the generic catch block can act as a “catch-all” block. When either an arithmetic error or incorrect input type error occurs, the thrown exception is “promoted” to an `Exception` error in the catch block. Figure 12-15 shows several executions of the `DivisionMistakeCaught4` application. Notice that no matter which type of mistake

occurs during execution, the general “Operation unsuccessful” message is displayed from the generic catch block.



```
C:\Java>java DivisionMistakeCaught4
Enter numerator >> 12
Enter denominator >> six
Operation unsuccessful

C:\Java>java DivisionMistakeCaught4
Enter numerator >> 12.0
Operation unsuccessful

C:\Java>java DivisionMistakeCaught4
Enter numerator >> 5
Enter denominator >> 0
Operation unsuccessful

C:\Java>
```

**Figure 12-15** Several executions of the `DivisionMistakeCaught4` application

As a new feature in Java 7, a catch block can also be written to catch multiple exception types. For example, the following catch block catches two `Exception` types. When either is caught, its local identifier is `e`.

```
catch(ArithmeticException, InputMismatchException e)
{
}
```

Although a method can throw any number of `Exception` types, many developers believe that it is poor style for a method to throw and catch more than three or four types. If it does, one of the following conditions might be true:

- Perhaps the method is trying to accomplish too many diverse tasks and should be broken up into smaller methods.
- Perhaps the `Exception` types thrown are too specific and should be generalized, as they are in the `DivisionMistakeCaught4` application in Figure 12-14.



Watch the video *Catching Multiple Exceptions*.

## TWO TRUTHS & A LIE

### Throwing and Catching Multiple Exceptions

1. When multiple `try` block statements throw `Exceptions`, multiple `catch` blocks might execute.
2. As soon as an `Exception` occurs, the `try` block that contains it is abandoned and the rest of its statements are unexecuted.
3. When a program contains multiple `catch` blocks, the first one that matches the thrown `Exception` type is the one that executes.

The false statement is #1. If you try more than one statement, only the first error-generating statement throws an `Exception`. Then the rest of the `try` block is abandoned.

## Using the `finally` Block

When you have actions you must perform at the end of a `try...catch` sequence, you can use a **`finally` block**. The code within a `finally` block executes regardless of whether the preceding `try` block identifies an `Exception`. Usually, you use a `finally` block to perform cleanup tasks that must happen whether or not any `Exceptions` occurred, and whether or not any `Exceptions` that occurred were caught. Figure 12-16 shows the format of a `try...catch` sequence that uses a `finally` block.

```
try
{
    // statements to try
}
catch(Exception e)
{
    // actions that occur if exception was thrown
}
finally
{
    // actions that occur whether catch block executed or not
}
```

**Figure 12-16** Format of `try...catch...finally` sequence

Compare Figure 12-16 to Figure 12-6 shown earlier in this chapter. When the `try` code works without error in Figure 12-6, control passes to the statements at the end of the method. Also, when the `try` code fails and throws an `Exception`, and the `Exception` is caught, the `catch` block executes and control again passes to the statements at the end of the method. At first



glance, it seems as though the statements at the end of the method always execute. However, the final set of statements might never execute for at least two reasons:

- An unplanned `Exception` might occur.
- The `try` or `catch` block might contain a `System.exit()`; statement.

Any `try` block might throw an `Exception` for which you did not provide a `catch` block. After all, `Exceptions` occur all the time without your handling them, as one did in the first `Division` application in Figure 12-2 earlier in this chapter. In the case of an unhandled `Exception`, program execution stops immediately, the `Exception` is sent to the operating system for handling, and the current method is abandoned. Likewise, if the `try` block contains an `exit()` statement, execution stops immediately.

When you include a `finally` block, you are assured that the `finally` statements will execute before the method is abandoned, even if the method concludes prematurely. For example, programmers often use a `finally` block when the program uses data files that must be closed. You will learn more about writing to and reading from data files in the next chapter. For now, however, consider the format shown in Figure 12-17, which represents part of the logic for a typical file-handling program:

```
try
{
    // Open the file
    // Read the file
    // Place the file data in an array
    // Calculate an average from the data
    // Display the average
}
catch(IOException e)
{
    // Issue an error message
    // System exit
}
finally
{
    // If the file is open, close it
}
```

**Figure 12-17** Pseudocode that tries reading a file and handles an `IOException`



If an application might throw several types of exceptions, you can try some code, catch the possible exception, try some more code, catch the possible exception, and so on. Usually, however, the superior approach is to try all the statements that might throw exceptions, then include all the needed `catch` blocks and an optional `finally` block. This is the approach shown in Figure 12-17, and it usually results in logic that is easier to follow.



You can avoid using a `finally` block, but you would need repetitious code. For example, instead of using the `finally` block in the pseudocode in Figure 12-17, you could insert the statement “if the file is open, close it” as both the last statement in the `try` block and the second-to-last statement in the `catch` block, just before `System exit`. However, writing code just once in a `finally` block is clearer and less prone to error.

The pseudocode in Figure 12-17 represents an application that opens a file; in Java, if a file does not exist when you open it, an input/output exception, or `IOException`, is thrown and a catch block can handle the error. However, because the application in Figure 12-17 uses an array, an uncaught `IndexOutOfBoundsException` might occur even though the file opened successfully. (Such an `Exception` occurs, as its name implies, when a subscript is not in the range of valid subscripts for an array.) The `IndexOutOfBoundsException` would not be caught by the existing catch block. Also, because the application calculates an average, it might divide by 0 and an `ArithmeticException` might occur; it also would not be caught. In any of these events, you might want to close the file before proceeding. By using the `finally` block, you ensure that the file is closed because the code in the `finally` block executes before control returns to the operating system. The code in the `finally` block executes no matter which of the following outcomes of the `try` block occurs:

- The `try` ends normally.
- The `catch` executes.
- An uncaught `Exception` causes the method to abandon prematurely. An uncaught `Exception` does not allow the `try` block to finish, nor does it cause the `catch` block to execute.



If a `try` block calls the `System.exit()` method and the `finally` block calls the same method, the `exit()` method in the `finally` block executes. The `try` block's `exit()` method call is abandoned.



C++ programmers are familiar with `try` and `catch` blocks, but C++ does not provide a `finally` block. C# and Visual Basic contain the keywords `try`, `catch`, and `finally`.

## TWO TRUTHS & A LIE

### Using the `finally` Block

1. The code within a `finally` block executes when a `try` block identifies an `Exception` that is not caught.
2. Usually, you use a `finally` block to perform cleanup tasks that must happen whether or not any `Exceptions` occurred, and whether or not any `Exceptions` that occurred were caught.
3. It's possible that the code that follows a `try...catch...finally` sequence might never execute—for example, if a `try` block throws an unhandled `Exception`.

The false statement is #1. The code within a `finally` block executes whether the preceding `try` block identifies an `Exception` or not, and whether an `Exception` is caught or not.

## Understanding the Advantages of Exception Handling

Before the inception of object-oriented programming languages, potential program errors were handled using somewhat confusing, error-prone methods. For example, a traditional, non-object-oriented, procedural program might perform three methods that depend on each other using code that provides error checking similar to the pseudocode in Figure 12-18.

```
call methodA()
if methodA() worked
{
    call methodB()
    if methodB() worked
    {
        call methodC()
        if methodC() worked
            everything's okay, so display finalResult
        else
            set errorCode to 'C'
    }
    else
        set errorCode to 'B'
}
else
    set errorCode to 'A'
```

**Figure 12-18** Pseudocode representing traditional error checking

The pseudocode in Figure 12-18 represents an application in which the logic must pass three tests before `finalResult` can be displayed. The program executes `methodA()`; it then calls `methodB()` only if `methodA()` is successful. Similarly, `methodC()` executes only when `methodA()` and `methodB()` are both successful. When any method fails, the program sets an appropriate `errorCode` to 'A', 'B', or 'C'. (Presumably, the `errorCode` is used later in the application.) The logic is difficult to follow, and the application's purpose and intended usual outcome—to display `finalResult`—is lost in the maze of `if` statements. Also, you can easily make coding mistakes within such a program because of the complicated nesting, indenting, and opening and closing of curly braces.

Compare the same program logic using Java's object-oriented, error-handling technique shown in Figure 12-19. Using the `try...catch` object-oriented technique provides the same results as the traditional method, but the statements of the program that do the "real" work (calling methods A, B, and C and displaying `finalResult`) are placed together, where their logic is easy to follow. The `try` steps should usually work without generating errors; after all, the errors are "exceptions." It is convenient to see these business-as-usual steps in one location. The unusual, exceptional events are grouped and moved out of the way of the primary action.

```
try
{
    call methodA() and maybe throw an exception
    call methodB() and maybe throw an exception
    call methodC() and maybe throw an exception
    everything's okay, so display finalResult
}
catch(methodA)'s error)
{
    set errorCode to "A"
}
catch(methodB)'s error)
{
    set errorCode to "B"
}
catch(methodC)'s error)
{
    set errorCode to "C"
}
```

**Figure 12-19** Pseudocode representing object-oriented exception handling

Besides clarity, an advantage to object-oriented exception handling is the flexibility it allows in the handling of error situations. When a method you write throws an `Exception`, the same method can catch the `Exception`, although it is not required to do so, and in most object-oriented programs it does not. Often, you don't want a method to handle its own `Exception`. In many cases, you want the method to check for errors, but you do not want to require a method to handle an error if it finds one. Another advantage to object-oriented exception handling is that you gain the ability to appropriately deal with `Exceptions` as you decide how to handle them. When you write a method, it can call another, catch a thrown `Exception`, and you can decide what you want to do. Just as a police officer has leeway to deal with a speeding driver differently depending on circumstances, programs can react to `Exceptions` specifically for their current purposes.

Methods are flexible partly because they are reusable—that is, a well-written method might be used by any number of applications. Each calling application might need to handle a thrown error differently, depending on its purpose. For example, an application that uses a method that divides values might need to terminate if division by 0 occurs. A different program simply might want the user to reenter the data to be used, and a third program might want to force division by 1. The method that contains the division statement can throw the error, but each calling program can assume responsibility for handling the error detected by the method in an appropriate way.

**TWO TRUTHS & A LIE****Understanding the Advantages of Exception Handling**

1. An advantage to using object-oriented error-handling techniques is that programs are clearer and more flexible.
2. An advantage to using object-oriented error-handling techniques is that when a method throws an exception, it will always be handled in the same, consistent way.
3. In many cases, you want a method to check for errors, but you do not want to require the method to handle an error if it finds one.

The false statement is #2. A well-written method might be used by any number of applications. An advantage of object-oriented exception-handling techniques is that each calling application can handle thrown errors differently, depending on its purpose.

539

**Specifying the Exceptions a Method Can Throw**

If a method throws an `Exception` that it will not catch but that will be caught by a different method, you must use the keyword `throws` followed by an `Exception` type in the method header. This practice is known as **exception specification**.

For example, Figure 12-20 shows a `PriceList` class used by a company to hold a list of prices for items it sells. For simplicity, there are only four prices and a single method that displays the price of a single item. The `displayPrice()` method accepts a parameter to use as the array subscript, but because the subscript could be out of bounds, the method contains a shaded `throws` clause, acknowledging it could throw an exception.

```
public class PriceList
{
    private static final double[] price = {15.99, 27.88, 34.56, 45.89};
    public static void displayPrice(int item) throws IndexOutOfBoundsException
    {
        System.out.println("The price is $" + price[item]);
    }
}
```

**Figure 12-20** The `PriceList` class

Figures 12-21 and 12-22 show two applications in which programmers have chosen to handle the exception differently. In the first class, `PriceListApplication1`, the programmer has chosen to handle the exception in the shaded `catch` block by displaying a price of \$0. In the second class, `PriceListApplication2`, the programmer has chosen to handle the exception by using the highest price in the array. Figure 12-23 shows several executions of each

program. Other programmers writing other applications that use the `PriceList` class could choose still different actions, but they all can use the flexible `displayPrice()` method because it doesn't limit the calling method's choice of recourse.

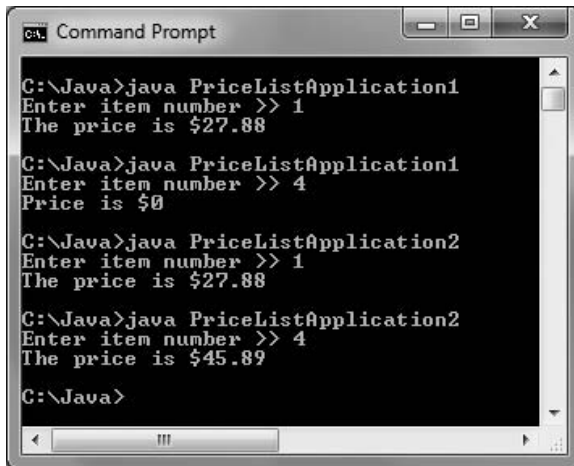
540

```
import java.util.*;
public class PriceListApplication1
{
    public static void main(String[] args)
    {
        int item;
        Scanner input = new Scanner(System.in);
        System.out.print("Enter item number >> ");
        item = input.nextInt();
        try
        {
            PriceList.displayPrice(item);
        }
        catch(IndexOutOfBoundsException e)
        {
            System.out.println("Price is $0");
        }
    }
}
```

Figure 12-21 The `PriceListApplication1` class

```
import java.util.*;
public class PriceListApplication2
{
    public static void main(String[] args)
    {
        int item;
        Scanner input = new Scanner(System.in);
        final int MAXITEM = 3;
        System.out.print("Enter item number >> ");
        item = input.nextInt();
        try
        {
            PriceList.displayPrice(item);
        }
        catch(IndexOutOfBoundsException e)
        {
            PriceList.displayPrice(MAXITEM);
        }
    }
}
```

Figure 12-22 The `PriceListApplication2` class



```
Command Prompt
C:\Java>java PriceListApplication1
Enter item number >> 1
The price is $27.88

C:\Java>java PriceListApplication1
Enter item number >> 4
Price is $0

C:\Java>java PriceListApplication2
Enter item number >> 1
The price is $27.88

C:\Java>java PriceListApplication2
Enter item number >> 4
The price is $45.89

C:\Java>
```

**Figure 12-23** Several executions of `PriceListApplication1` and `PriceListApplication2`

For most Java methods that you write, you do not use a `throws` clause. For example, you have not needed to use a `throws` clause in any of the many programs you have written while working through this book; however, in those methods, if you divided by 0 or went beyond an array's bounds, an `Exception` was thrown nevertheless. Most of the time, you let Java handle any `Exception` by shutting down the program. Imagine how unwieldy your programs would become if you were required to provide instructions for handling every possible error, including equipment failures and memory problems. Most exceptions never have to be explicitly thrown or caught, nor do you have to include a `throws` clause in the headers of methods that automatically throw these `Exceptions`. The only exceptions that must be caught or named in a `throws` clause are the type known as *checked* exceptions.

Java's exceptions can be categorized into two types:

- **Unchecked exceptions**—These exceptions inherit from the `Error` class or the `RuntimeException` class. Although you can handle these exceptions in your programs, you are not required to do so. For example, dividing by zero is a type of `RuntimeException`, and you are not required to handle this exception—you can simply let the program terminate.
- **Checked exceptions**—These exceptions are the type that programmers should anticipate and from which programs should be able to recover. All exceptions that you explicitly throw and that descend from the `Exception` class are checked exceptions.

Java programmers say that checked exceptions are subject to the **catch or specify requirement**, which means if you throw a checked exception from a method, you must do one of the following:

- Catch it within the method.
- Specify the exception in your method header's `throws` clause.

Code that uses a checked exception will not compile if the catch or specify rule is not followed.

If you write a method with a `throws` clause in the header, then any method that uses your method must do one of the following:

- Catch and handle the possible exception.
- Declare the exception in its `throws` clause. The called method can then rethrow the exception to yet another method that might either catch it or throw it yet again.

In other words, when an exception is a checked exception, client programmers are forced to deal with the possibility that an exception will be thrown.



Some programmers feel that using checked exceptions is an example of “syntactic salt.” **Syntactic sugar** is a term coined by Peter J. Landin to describe aspects of a computer language that make it “sweeter,” or easier, for programmers to use. For example, you learned in Chapter 1 that you do not have to write `import java.lang;` at the top of every Java program file because the package is automatically imported for you. The metaphor has been extended by the term **syntactic salt**, which is a language feature designed to make it harder to write bad code.

If you write a method that explicitly throws a checked `Exception` that is not caught within the method, Java requires that you use the `throws` clause in the header of the method. Using the `throws` clause does not mean that the method *will* throw an `Exception`—everything might go smoothly. Instead, it means the method *might* throw an `Exception`. You include the `throws` clause in the method header so applications that use your methods are notified of the potential for an `Exception`.



In Chapter 3, you learned that a method’s signature is the combination of the method name and the number, types, and order of arguments. Some programmers argue that any `throws` clause is also part of the signature, but most authorities disagree. You cannot create a class that contains multiple methods that differ only in their `return` types; such methods are not overloaded. The same is true for methods with the same signatures that differ only in their `throws` clauses; the compiler considers the methods to have an identical signature. Instead of saying that the `throws` clause is part of the method’s signature, you might prefer to say that it is part of the method’s interface.



A method that overrides another cannot throw an exception unless it throws the same type as its parent or a subclass of its parent’s thrown type. These rules do not apply to overloaded methods. Any exceptions may (or may not) be thrown from one version of an overloaded method without considering what exceptions are thrown by other versions of an overloaded method.

To be able to use a method to its full potential, you must know the method’s name and three additional pieces of information:

- The method’s `return` type
- The type and number of arguments the method requires
- The type and number of `Exceptions` the method throws

To use a method, you must know what types of arguments are required. You can call a method without knowing its `return` type, but if you do, you can’t benefit from any value that the method returns. (Also, if you use a method without knowing its `return` type, you probably don’t understand the purpose of the method.) Likewise, you can’t make sound



decisions about what to do in case of an error if you don't know what types of Exceptions a method might throw.

When a method might throw more than one Exception type, you can specify a list of potential Exceptions in the method header by separating them with commas. As an alternative, if all the exceptions descend from the same parent, you can specify the more general parent class. For example, if your method might throw either an `ArithmeticException` or an `ArrayIndexOutOfBoundsException`, you can just specify that your method throws a `RuntimeException`. One advantage to this technique is that when your method is modified to include more specific `RuntimeException`s in the future, the method header will not change. This saves time and money for users of your methods, who will not have to modify their own methods to accommodate new `RuntimeException` types.

An extreme alternative is simply to specify that your method throws a general Exception, so that all exceptions are included in one clause. Doing this simplifies the exception specification you write. However, using this technique disguises information about the specific types of exceptions that might occur, and such information usually has value to users of your methods.



Usually, you declare only checked exceptions. Remember that runtime exceptions can occur anywhere in a program, and they can be numerous. Programs would be less clear if you had to account for runtime exceptions in every method declaration. Therefore, the Java compiler does not require that you catch or specify runtime exceptions.



Watch the video *Specifying Exceptions*.

## TWO TRUTHS & A LIE

### Specifying the Exceptions a Method Can Throw

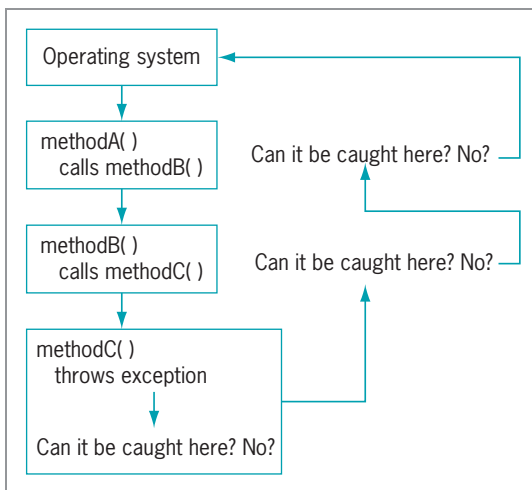
1. Exception specification is the practice of listing possible Exceptions in a `throws` clause in a method header.
2. Many exceptions never have to be explicitly thrown or caught, nor do you have to include a `throws` clause in the headers of methods that automatically throw these Exceptions.
3. If you write a method with a `throws` clause for a checked exception in the header, then any method that uses your method must catch and handle the possible exception.

The false statement is #3. If you write a method with a `throws` clause for a checked exception in the header, then any method that uses your method must catch and handle the possible exception or declare the exception in its `throws` clause so the exception can be rethrown.

## Tracing Exceptions Through the Call Stack

When one method calls another, the computer's operating system must keep track of where the method call came from, and program control must return to the calling method when the called method is completed. For example, if `methodA()` calls `methodB()`, the operating system has to “remember” to return to `methodA()` when `methodB()` ends. Likewise, if `methodB()` calls `methodC()`, the computer must “remember” while `methodC()` executes to return to `methodB()` and eventually to `methodA()`. The memory location known as the **call stack** is where the computer stores the list of method locations to which the system must return.

When a method throws an `Exception` and the method does not catch it, the `Exception` is thrown to the next method up the call stack, or in other words, to the method that called the offending method. Figure 12-24 shows how the call stack works. If `methodA()` calls `methodB()`, and `methodB()` calls `methodC()`, and `methodC()` throws an `Exception`, Java first looks for a `catch` block in `methodC()`. If none exists, Java looks for the same thing in `methodB()`. If `methodB()` does not have a `catch` block, Java looks to `methodA()`. If `methodA()` cannot catch the `Exception`, it is thrown to the Java Virtual Machine, which displays a message at the command prompt.



**Figure 12-24** Cycling through the call stack

For example, examine the application in Figure 12-25. The `main()` method of the application calls `methodA()`, which displays a message and calls `methodB()`. Within `methodB()`, another message is displayed and `methodC()` is called. In `methodC()`, yet another message is displayed. Then, a three-integer array is declared, and the program attempts to display the fourth element in the array. This program compiles correctly—no error is detected until `methodC()` attempts to access the out-of-range array element. In Figure 12-25, the comments indicate line numbers so you can more easily follow the sequence of generated error messages. You probably would not add such comments to a working application. Figure 12-26 shows the output when the application executes.

```

public class DemoStackTrace
{
    public static void main(String[] args)
    {
        methodA(); // line 5
    }
    public static void methodA()
    {
        System.out.println("In methodA()");
        methodB(); // line 10
    }
    public static void methodB()
    {
        System.out.println("In methodB()");
        methodC(); // line 15
    }
    public static void methodC()
    {
        System.out.println("In methodC()");
        int [] array = {0, 1, 2};
        System.out.println(array[3]); // line 21
    }
}

```

**Don't Do It**  
 You never would purposely use an out-of-range subscript in a professional program.

Figure 12-25 The DemoStackTrace class

```

C:\Java>java DemoStackTrace
In methodA()
In methodB()
In methodC()
Exception in thread "main" java.lang.ArrayIndexOutOfBoundsException: 3
    at DemoStackTrace.methodC(DemoStackTrace.java:21)
    at DemoStackTrace.methodB(DemoStackTrace.java:15)
    at DemoStackTrace.methodA(DemoStackTrace.java:10)
    at DemoStackTrace.main(DemoStackTrace.java:5)

C:\Java>

```

Figure 12-26 Error messages generated by the DemoStackTrace application

As you can see in Figure 12-26, three messages are displayed, indicating that `methodA()`, `methodB()`, and `methodC()` were called in order. However, when `methodC()` attempts to access the out-of-range element in the array, an `ArrayIndexOutOfBoundsException` is automatically thrown. The error message generated shows that the exception occurred at line 21 of the file in `methodC()`, which was called in line 15 of the file by `methodB()`, which was called in line 10 of the file by `methodA()`, which was called by the `main()` method in line 5 of the file. Using this list of error messages, you could track down the location where the error was generated. Of course, in a larger application that contains thousands of lines of code, the stack trace history list would be even more useful.

The technique of cycling through the methods in the stack has great advantages because it allows methods to handle Exceptions wherever the programmer has decided it is most appropriate—including allowing the operating system to handle the error. However, when a program uses several classes, the disadvantage is that the programmer finds it difficult to locate the original source of an Exception.

You have already used the Throwable method `getMessage()` to obtain information about an Exception. Another useful Exception method is the `printStackTrace()` method. When you catch an Exception, you can call `printStackTrace()` to display a list of methods in the call stack so you can determine the location of the Exception.

For example, Figure 12-27 shows a `DemoStackTrace2` application in which the `printStackTrace()` method produces a trace of the trail taken by a thrown exception. The differences in the executable statements from the `DemoStackTrace` application are shaded. The call to `methodB()` has been placed in a `try` block so that the exception can be caught. Instead of throwing the exception to the operating system, this application catches the exception, displays a stack trace history list, and continues to execute. The output of the list of methods in Figure 12-28 is similar to the one shown in Figure 12-26, but the application does not end abruptly.

```
public class DemoStackTrace2
{
    public static void main(String[] args)
    {
        methodA(); // line 5
    }
    public static void methodA()
    {
        System.out.println("In methodA()");
        try
        {
            methodB(); // line 12
        }
        catch(ArrayIndexOutOfBoundsException error)
        {
            System.out.println("In methodA() - The stack trace:");
            error.printStackTrace();
        }
        System.out.println("methodA() ends normally.");
        System.out.println("Application could continue " +
            "from this point.");
    }
    public static void methodB()
    {
        System.out.println("In methodB()");
        methodC(); // line 26
    }
}
```

Figure 12-27 The `DemoStackTrace2` class (continues)

(continued)

```

public static void methodC()
{
    System.out.println("In methodC()");
    int[] array = {0, 1, 2};
    System.out.println(array[3]); // line 32
}
}

```

Figure 12-27 The DemoStackTrace2 class

```

C:\Java>java DemoStackTrace2
In methodA()
In methodB()
In methodC()
In methodA() - The stack trace:
java.lang.ArrayIndexOutOfBoundsException: 3
    at DemoStackTrace2.methodC(DemoStackTrace2.java:32)
    at DemoStackTrace2.methodB(DemoStackTrace2.java:26)
    at DemoStackTrace2.methodA(DemoStackTrace2.java:12)
    at DemoStackTrace2.main(DemoStackTrace2.java:5)
methodA() ends normally.
Application could continue from this point.
C:\Java>

```

Figure 12-28 Output of the DemoStackTrace2 application

Usually, you do not want to place a `printStackTrace()` method call in a finished program. The typical application user has no interest in the cryptic messages that display. However, while you are developing an application, `printStackTrace()` can be a useful tool for diagnosing your class's problems.

## TWO TRUTHS & A LIE

### Tracing Exceptions Through the Call Stack

1. The memory location known as the call stack is where the computer stores the list of locations to which the system must return after each method call.
2. When a method throws an `Exception` and the method does not catch it, the `Exception` is thrown to the next method down the call stack, or in other words, to the next method that the offending method calls.
3. When you catch an `Exception`, you can call `printStackTrace()` to display a list of methods in the call stack so you can determine the location of the `Exception`; however, usually you do not want to place a `printStackTrace()` method call in a finished program.

The false statement is #2. When a method throws an `Exception` and the method does not catch it, the `Exception` is thrown to the next method up the call stack, or in other words, to the method that called the offending method.

## Creating Your Own Exceptions

Java provides over 40 categories of Exceptions that you can use in your programs. However, Java's creators could not predict every condition that might be an Exception in your applications. For example, you might want to declare an Exception when your bank balance is negative or when an outside party attempts to access your e-mail account. Most organizations have specific rules for exceptional data; for example, an employee number must not exceed three digits, or an hourly salary must not be less than the legal minimum wage. Of course, you can handle these potential error situations with `if` statements, but Java also allows you to create your own Exceptions.

To create your own throwable Exception, you must extend a subclass of `Throwable`. Recall from Figure 12-1 that `Throwable` has two subclasses, `Exception` and `Error`, which are used to distinguish between recoverable and nonrecoverable errors. Because you always want to create your own Exceptions for recoverable errors, you should extend your Exceptions from the `Exception` class. You can extend any existing `Exception` subclass, such as `ArithmeticException` or `NullPointerException`, but usually you want to inherit directly from `Exception`. When you create an `Exception` subclass, it's conventional to end its name with `Exception`.

The `Exception` class contains four constructors as follows:

- `Exception()`—Constructs a new exception with `null` as its detail message
- `Exception(String message)`—Constructs a new exception with the specified detail message
- `Exception(String message, Throwable cause)`—Constructs a new exception with the specified detail message and cause
- `Exception(Throwable cause)`—Constructs a new exception with the specified cause and a detail message of `cause.toString()`, which typically contains the class and the detail message of `cause`, or `null` if the cause argument is `null`

For example, Figure 12-29 shows a `HighBalanceException` class. Its constructor contains a single statement that passes a description of an error to the parent `Exception` constructor. This `String` would be retrieved if you called the `getMessage()` method with a `HighBalanceException` object.

```
public class HighBalanceException extends Exception
{
    public HighBalanceException()
    {
        super("Customer balance is high");
    }
}
```

**Figure 12-29** The `HighBalanceException` class

Figure 12-30 shows a `CustomerAccount` class that uses a `HighBalanceException`. The `CustomerAccount` constructor header indicates that it might throw a `HighBalanceException` (see the first shaded statement); if the balance used as an argument to the constructor exceeds a set limit, a new, unnamed instance of the `HighBalanceException` class is thrown (see the second shaded statement).

```
public class CustomerAccount
{
    private int acctNum;
    private double balance;
    public static double HIGH_CREDIT_LIMIT = 20000.00;
    public CustomerAccount(int num, double bal) throws HighBalanceException
    {
        acctNum = num;
        balance = bal;
        if(balance > HIGH_CREDIT_LIMIT)
            throw(new HighBalanceException());
    }
}
```

**Figure 12-30** The `CustomerAccount` class



In the `CustomerAccount` class in Figure 12-30, you could choose to instantiate a named `HighBalanceException` and throw it when the balance exceeds the credit limit. By waiting and instantiating an unnamed object only when it is needed, you improve program performance.



When a constructor throws an exception, no object is constructed; its intended reference variable value will be `null`.

Figure 12-31 shows an application that instantiates a `CustomerAccount`. In this application, a user is prompted for an account number and balance. After the values are entered, an attempt is made to construct a `CustomerAccount` in a try block (as shown in the first shaded section). If the attempt is successful—that is, if the `CustomerAccount` constructor does not throw an `Exception`—the `CustomerAccount` information is displayed in a dialog box. However, if the `CustomerAccount` constructor does throw a `HighBalanceException`, the catch block receives it (as shown in the second shaded section) and displays a message. A different application could take any number of different actions; for example, it could display the return value of the `getMessage()` method, construct a `CustomerAccount` object with a lower balance, or construct a different type of object—perhaps a child of `CustomerAccount` called `PreferredCustomerAccount` that allows a higher balance. Figure 12-32 shows typical output of the application in a case in which a customer's balance is too high.

```
import javax.swing.*;
public class UseCustomerAccount
{
    public static void main(String[] args)
    {
        int num;
        double balance;
        String input;
        input = JOptionPane.showInputDialog(null,
            "Enter account number");
        num = Integer.parseInt(input);
        input = JOptionPane.showInputDialog(null, "Enter balance due");
        balance = Double.parseDouble(input);
        try
        {
            CustomerAccount ca = new CustomerAccount(num, balance);
            JOptionPane.showMessageDialog(null, "Customer #" +
                num + " has a balance of $" + balance);
        }
        catch( HighBalanceException hbe)
        {
            JOptionPane.showMessageDialog(null, "Customer #" +
                num + " has a balance of $" + balance +
                " which is higher than the credit limit");
        }
    }
}
```

Figure 12-31 The UseCustomerAccount class



Figure 12-32 Typical output of UseCustomerAccount application

Instead of hard coding error messages into your exception classes, as shown in Figure 12-31, you might consider creating a catalog of possible messages to use. This approach provides several advantages:

- All the messages are stored in one location instead of being scattered throughout the program, making them easier to see and modify.
- The list of possible errors serves as a source of documentation, listing potential problems when running the application.



- Other applications might want to use the same catalog of messages.
- If your application will be used internationally, you can provide messages in multiple languages, and other programmers can use the version that is appropriate for their country.



You can throw any type of `Exception` at any time, not just `Exceptions` of your own creation. For example, within any program you can code `throw(new RuntimeException());`. Of course, you would want to do so only with good reason because Java handles `RuntimeExceptions` for you by stopping the program. Because you cannot anticipate every possible error, Java's automatic response is often the best course of action.

You should not create an excessive number of special `Exception` types for your classes, especially if the Java development environment already contains an `Exception` that will catch the error. Extra `Exception` types add complexity for other programmers who use your classes. However, when appropriate, specialized `Exception` classes provide an elegant way for you to handle error situations. They enable you to separate your error code from the usual, nonexceptional sequence of events; they allow errors to be passed up the stack and traced; and they allow clients of your classes to handle exceptional situations in the manner most suitable for their application.

## TWO TRUTHS & A LIE

### Creating Your Own Exceptions

1. You must create your own `Exception` classes for your programs to be considered truly object-oriented.
2. To create your own throwable `Exception`, you should extend your `Exceptions` from the `Exception` class.
3. The `Exception` class contains four constructors, including a default constructor and one that requires a `String` that contains the message that can be returned by the `getMessage()` method.

The false statement is #1. You are not required to throw exceptions in object-oriented programs. However, Java does provide many built-in categories of `Exceptions` that you can use, and you also can create your own `Exception` classes.

## Using Assertions

In Chapter 1, you learned that you might inadvertently create syntax or logical errors when you write a program. Syntax errors are mistakes using the Java language; they are compile-time errors that prevent a program from compiling and creating an executable file with a `.class` extension.

In Chapter 1, you also learned that a program might contain logical errors even though it is free of syntax errors. Some logical errors cause runtime errors, or errors that cause a program to terminate. In this chapter, you learned how to use `Exceptions` to handle many of these kinds of errors.

Some logical errors do not cause a program to terminate, but nevertheless produce incorrect results. For example, if a payroll program should determine gross pay by multiplying hours worked by hourly pay rate, but you inadvertently divide the numbers, no runtime error occurs and no `Exception` is thrown, but the output is wrong. An **assertion** is a Java language feature that can help you detect such logic errors and debug a program. You use an **assert statement** to create an assertion; when you use an assert statement, you state a condition that should be true, and Java throws an `AssertionError` when it is not.

The syntax of an assert statement is:

```
assert booleanExpression : optionalErrorMessage
```

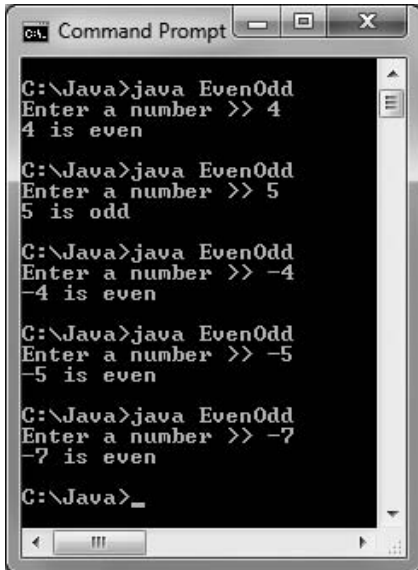
The Boolean expression in the assert statement should always be true if the program is working correctly. The `optionalErrorMessage` is displayed if the `booleanExpression` is false.

Figure 12-33 contains an application that prompts a user for a number and passes it to a method that determines whether a value is even. Within the `isEven()` method, the remainder is taken when the passed parameter is divided by 2. If the remainder after dividing by 2 is 1, `result` is set to `false`. For example, 1, 3, and 5 all are odd, and all result in a value of 1 when `% 2` is applied to them. If the remainder after dividing by 2 is not 1, `result` is set to `true`. For example, 2, 4, and 6 all are even, and all have a 0 remainder when `% 2` is applied to them.

```
import java.util.Scanner;
public class EvenOdd
{
    public static void main(String[] args)
    {
        Scanner input = new Scanner(System.in);
        int number;
        System.out.print("Enter a number >> ");
        number = input.nextInt();
        if(isEven(number))
            System.out.println(number + " is even");
        else
            System.out.println(number + " is odd");
    }
    public static boolean isEven(int number)
    {
        boolean result;
        if(number % 2 == 1)
            result = false;
        else
            result = true;
        return result;
    }
}
```

**Figure 12-33** The flawed EvenOdd program without an assertion

Figure 12-34 shows several executions of the application in Figure 12-33. The output seems correct until the last two executions. The values  $-5$  and  $-7$  are classified as even although they are odd. An assertion might help you to debug this application.



```
ca. Command Prompt
C:\Java>java EvenOdd
Enter a number >> 4
4 is even

C:\Java>java EvenOdd
Enter a number >> 5
5 is odd

C:\Java>java EvenOdd
Enter a number >> -4
-4 is even

C:\Java>java EvenOdd
Enter a number >> -5
-5 is even

C:\Java>java EvenOdd
Enter a number >> -7
-7 is even

C:\Java>_
```

**Figure 12-34** Typical executions of the EvenOdd application

Figure 12-35 contains a new version of the `isEven()` method to which the shaded assert statement has been added. The statement asserts that when the remainder of a number divided by 2 is not 1, it must be 0. If the expression is not true, a message is created using the values of both number and its remainder after dividing by 2.

```
public static boolean isEven(int number)
{
    boolean result;
    if(number % 2 == 1)
        result = false;
    else
    {
        result = true;
        assert number % 2 == 0 : number + "% 2 is " + number % 2;
    }
    return result;
}
```

**Figure 12-35** The flawed `isEven()` method with an assertion

If you add the assertion shown in Figure 12-35 and then compile and execute the program in the usual way, you get the same incorrect output as in Figure 12-34. To enable the assertion, you must use the `-ea` option when you execute the program; *ea* stands for *enable assertion*. Figure 12-36 shows the command prompt with an execution that uses the `-ea` option.



```
Command Prompt
C:\Java>java -ea EvenOdd
Enter a number >> -5
Exception in thread "main" java.lang.AssertionError: Number % 2 is -1
    at EvenOdd.isEven(EvenOdd.java:23)
    at EvenOdd.main(EvenOdd.java:10)
C:\Java>
```

**Figure 12-36** Executing an application using the enable assertion option

When the `EvenOdd` program executes and the user enters `-5`, the program displays the messages in Figure 12-36 instead of displaying incorrect output. You can see from the message that an `AssertionError` was thrown and that the value of `-5 % 2` is `-1`, not `1` as you had assumed. The remainder operator results in a negative value when one of its operands is negative, making the output in this program incorrect.

When the programmer sees that `-5 % 2` is `-1`, the reasonable course of action is to return to the source code and change the logic.

Several adjustments are possible:

- The programmer might decide to convert the parameter to the `isEven()` method to its absolute value before using the remainder operator, as in the following:  

```
number = Math.abs(number);
```
- Another option would be to change the `if` statement to test for even values by comparing `number % 2` to `0` first, as follows:

```
if(number % 2 == 0)
    result = true;
else
    result = false;
```

Then values of both `1` and `-1` would be classified as not even.

- Other options might include displaying an error message when negative values are encountered, reversing the `result` values of `true` and `false` when the parameter is negative, or throwing an exception.

An experienced programmer might have found the error in the original `EvenOdd` application without using an assertion. For example, the programmer might have previously used the remainder operator with a negative operand, remembered that the result might be negative, and changed the code accordingly. Alternatively, the programmer could have inserted statements to display values at strategic points in the program. However, after the mistake is found and fixed, any extra display statements should be removed when the final product is

ready for distribution to users. In contrast, any `assert` statements can be left in place, and if the user does not use the `-ea` option when running the program, the user will see no evidence that the `assert` statements exist. Placing `assert` statements in key program locations can reduce development and debugging time.

You do not want to use assertions to check for every type of error that could occur in a program. For example, if you want to ensure that a user enters numeric data, you should use exception-handling techniques that provide the means for your program to recover from the mistake. If you want to ensure that the data falls within a specific range, you should use a decision or a loop. Assertions are meant to be helpful in the development stage of a program, not when it is in production and in the hands of users.

## TWO TRUTHS & A LIE

### Using Assertions

1. All logical errors cause a program to terminate, and they should be handled by throwing and catching `Exceptions`.
2. The Boolean expression in an `assert` statement should always be `true` if the program is working correctly.
3. To enable an assertion, you must use the `-ea` option when you execute the program.

The false statement is #1. Many logical errors do not cause program termination—they simply produce incorrect results.

## You Do It

### Throwing and Catching Exceptions

In this section, you will create an application in which the user enters two values to be divided. The application catches a `NumberFormatException` if either of the entered values is not an integer, and it catches an `ArithmeticException` if you attempt to divide by 0.

#### To write an application that throws and catches `Exceptions`:

1. Open a new file in your text editor, and type the first few lines of an interactive application named `ExceptionDemo`.

```
import javax.swing.*.*;
public class ExceptionDemo
{
    public static void main(String[] args)
    {
```

2. Declare three integers—two to be input by the user and a third to hold the result after dividing the first two. The numerator and denominator variables must be assigned starting values because their values will be entered within a try block. The compiler understands that a try block might not complete; that is, it might throw an `Exception` before it is through. Therefore, when the application reaches the point where numerator and denominator are displayed, it might attempt to display invalid, or “garbage,” values. The compiler does not allow you to display variables if it is not certain that these variables were provided with legitimate values beforehand. Also declare an input `String` to hold the return value of the `JOptionPane.showInputDialog()` method.

```
int numerator = 0, denominator = 0, result;  
String inputString;
```

3. Add a try block that prompts the user for two values, converts each entered `String` to an integer, and divides the values, producing `result`.

```
try  
{  
    inputString = JOptionPane.showInputDialog(null,  
        "Enter a number to be divided");  
    numerator = Integer.parseInt(inputString);  
    inputString = JOptionPane.showInputDialog(null,  
        "Enter a number to divide into the first number");  
    denominator = Integer.parseInt(inputString);  
    result = numerator / denominator;  
}
```

4. Add a catch clause that catches an `ArithmeticException` if an attempt is made to divide by 0. If the catch block executes, it displays the `String` returned by the `getMessage()` method message and assigns 0 to `result`.

```
catch(ArithmeticException exception)  
{  
    JOptionPane.showMessageDialog(null, exception.getMessage());  
    result = 0;  
}
```

5. Add a second catch clause that catches a `NumberFormatException` if either user entry cannot be converted to an integer. If this clause executes, display an error message, set numerator and denominator to a default value of 999, and force `result` to 1.

```
catch(NumberFormatException exception)  
{  
    JOptionPane.showMessageDialog(null,  
        "This application accepts digits only!");  
    numerator = 999;  
    denominator = 999;  
    result = 1;  
}
```

6. Whether the `try` block succeeds or not, display the result (which might have been set to 0 or 1). Include closing curly braces for the `main()` method and for the class.

```

        JOptionPane.showMessageDialog(null, numerator + " / " +
            denominator + "\nResult is " + result);
    }
}

```

7. Save the file as **ExceptionDemo.java**, then compile and execute the application. Enter two nonzero integer values. For example, Figure 12-37 shows the output when the user enters 12 and 3 as the two input values. The application completes successfully. Click **OK** to end the application.



**Figure 12-37** Output of the `ExceptionDemo` application when the user enters 12 and 3

8. Execute the application again using 0 as the second input value. For example, when the user enters 12 and 0, the first output looks like the dialog box on the left in Figure 12-38. Click **OK**, and the next dialog box looks like the one on the right in Figure 12-38. The output shows that the `Exception` was caught successfully, setting the result to 0. Click **OK** to end the application.



**Figure 12-38** Output of the `ExceptionDemo` application when the user enters 12 and 0

9. Run the `ExceptionDemo` application again. When prompted for the first value, enter some text or a floating-point value instead of an integer. For example, when the user enters *a*, the output looks like Figure 12-39.



**Figure 12-39** Output of the `ExceptionDemo` application when the user enters *a* for the first value

## Creating a Class That Automatically Throws Exceptions

Next, you will create a class that contains two methods that throw `Exceptions` but don't catch them. The `PickMenu` class allows restaurant customers to choose from a dinner menu. Before you create `PickMenu`, you will create the `Menu` class, which lists dinner choices and allows a user to make a selection.

### To create the `Menu` class:

1. Open a new file in your text editor, and then enter the following import statement, class header, and opening curly brace for the `Menu` class:

```
import javax.swing.*;  
public class Menu  
{
```

2. Type the following `String` array for three entree choices. Also include a `String` to build the menu that you will display and an integer to hold the numeric equivalent of the selection.

```
private String[] entreeChoice = {"Rosemary Chicken",  
    "Beef Wellington", "Maine Lobster"};  
private String menu = "";  
private int choice;
```

3. Add the `displayMenu()` method, which lists each entree option with a corresponding number the customer can type to make a selection. Even though the allowable `entreeChoice` array subscripts are 0, 1, and 2, most users would expect to type 1, 2, or 3. So, you code `x + 1` rather than `x` as the number in the prompt. After the user enters a selection, convert it to an integer. Return the `String` that corresponds to the user's menu selection—the one with the subscript that is 1 less than the entered value. After the closing curly brace for the `displayMenu()` method, add the closing curly brace for the class.

```
public String displayMenu()  
{  
    for(int x = 0; x < entreeChoice.length; ++x)  
    {  
        menu = menu + "\n" + (x + 1) + " for " +  
            entreeChoice[x];  
    }  
    String input = JOptionPane.showInputDialog(null,  
        "Type your selection, then press Enter." + menu);  
    choice = Integer.parseInt(input);  
    return(entreeChoice[choice - 1]);  
}  
}
```



The curly braces are not necessary in the `for` loop of the `displayMenu()` method because the loop contains only one statement. However, in a later exercise, you will add another statement within this block.



4. Examine the code within the `displayMenu()` method. Consider the exceptions that might occur. The user might not type an integer, so the `parseInt()` method can fail, and even if the user does type an integer, it might not be in the range allowed to access the `entreeChoice` array. Therefore, the `displayMenu()` method, like most methods in which you rely on the user to enter data, might throw exceptions that you can anticipate. (Of course, any method might throw an unanticipated exception.)
5. Save the file as **Menu.java**, and compile the class using the **javac** command.

## Creating a Class That Passes on an Exception

Next, you will create the `PickMenu` class, which lets a customer choose from the available dinner entree options. The `PickMenu` class declares a `Menu` and a `String` named `guestChoice` that holds the name of the entree the customer selects.

To enable the `PickMenu` class to operate with different kinds of `Menus` in the future, you will pass a `Menu` to `PickMenu`'s constructor. This technique provides two advantages: First, when the menu options change, you can alter the contents of the `Menu.java` file without changing any of the code in programs that use `Menu`. Second, you can extend `Menu`, perhaps to `VegetarianMenu`, `LowSaltMenu`, or `KosherMenu`, and still use the existing `PickMenu` class. When you pass any `Menu` or `Menu` subclass into the `PickMenu` constructor, the correct customer options appear.

The `PickMenu` class is unlikely to directly generate any exceptions because it does not request user input. (Keep in mind that any class might generate an exception for such uncontrollable events as the system not having enough memory available.) However, `PickMenu` declares a `Menu` object; the `Menu` class, because it relies on user input, is likely to generate an `Exception`.

### To create the `PickMenu` class:

1. Open a new file in your text editor, and then add the following first few lines of the `PickMenu` class with its data fields (a `Menu` and a `String` that reflect the customer's choice):

```
import javax.swing.*;  
public class PickMenu  
{  
    private Menu briefMenu;  
    private String guestChoice = new String();
```

2. Enter the following `PickMenu` constructor, which receives an argument representing a `Menu`. The constructor assigns the `Menu` that is the argument to the local `Menu`, and then calls the `setGuestChoice()` method, which prompts the user to select from the available menu. The `PickMenu()` constructor might throw an `Exception` because it calls `setGuestChoice()`, which calls `displayMenu()`, a method that uses keyboard input and might throw an `Exception`.

```
public PickMenu(Menu theMenu)  
{  
    briefMenu = theMenu;  
    setGuestChoice();  
}
```

3. The following `setGuestChoice()` method displays the menu and reads keyboard data entry (so the method throws an `Exception`). It also displays instructions and then retrieves the user's selection.

```
public void setGuestChoice()
{
    JOptionPane.showMessageDialog(null,
        "Choose from the following menu:");
    guestChoice = briefMenu.displayMenu();
}
```

4. Add the following `getGuestChoice()` method that returns a guest's `String` selection from the `PickMenu` class. Also, add a closing curly brace for the class.

```
public String getGuestChoice()
{
    return(guestChoice);
}
```

5. Save the file as `PickMenu.java`, and compile it using the `javac` command.

## Creating an Application That Can Catch Exceptions

You have created a `Menu` class that simply holds a list of food items, displays itself, and allows the user to make a selection. You also created a `PickMenu` class with fields that hold a user's specific selection from a given menu and methods to get and set values for those fields. The `PickMenu` class might throw `Exceptions`, but it contains no methods that catch those `Exceptions`. Next, you will write an application that uses the `PickMenu` class. This application can catch `Exceptions` that `PickMenu` throws.

### To write the `PlanMenu` class:

1. Open a new file in your text editor, and start entering the following `PlanMenu` class, which has just one method—a `main()` method:

```
import javax.swing.*;
public class PlanMenu
{
    public static void main(String[] args)
    {
```

2. Construct the following `Menu` named `briefMenu`, and declare a `PickMenu` object that you name `entree`. You do not want to construct a `PickMenu` object yet because you want to be able to catch the `Exception` that the `PickMenu` constructor might throw. Therefore, you want to wait and construct the `PickMenu` object within a `try` block. For now, you just declare `entree` and assign it `null`. Also, you declare a `String` that holds the customer's menu selection.

```
Menu briefMenu = new Menu();
PickMenu entree = null;
String guestChoice = new String();
```

3. Write the following `try` block that constructs a `PickMenu` item. If the construction is successful, the next statement assigns a selection to the `entree` object. Because `entree`

is a `PickMenu` object, it has access to the `getGuestChoice()` method in the `PickMenu` class, and you can assign the method's returned value to the `guestChoice` String.

```
try
{
    PickMenu selection = new PickMenu(briefMenu);
    entree = selection;
    guestChoice = entree.getGuestChoice();
}
```

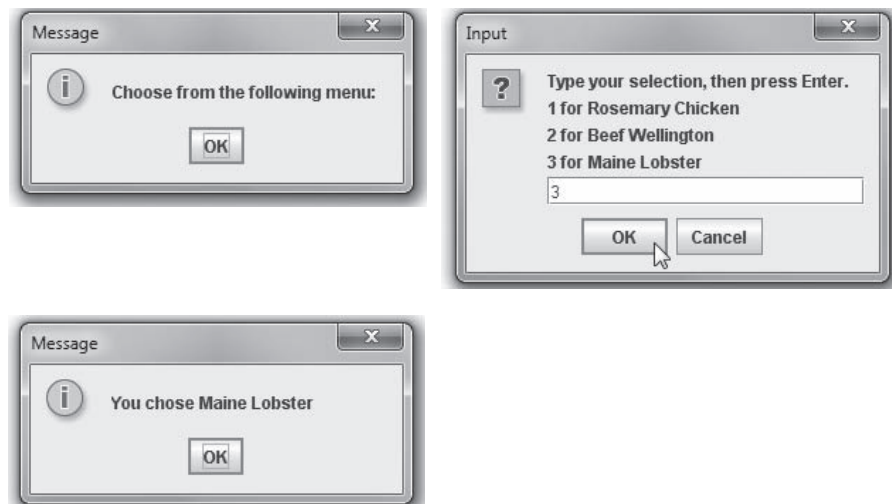
- The catch block must immediately follow the try block. When the try block fails, `guestChoice` will not have a valid value, so recover from the Exception by assigning a value to `guestChoice` within the following catch block:

```
catch(Exception error)
{
    guestChoice = "an invalid selection";
}
```

- After the catch block, the application continues. Use the following code to display the customer's choice at the end of the `PlanMenu` application, and then add closing curly braces for the `main()` method and the class:

```
    JOptionPane.showMessageDialog(null,
        "You chose " + guestChoice);
}
}
```

- Save the file as **PlanMenu.java**, and then compile and execute it. Read the instructions, click **OK**, choose an entree by typing its number from the menu, and click **OK** again. Confirm that the menu selection displayed is the one you chose, and click **OK** to dismiss the last dialog box. Figure 12-40 shows the first dialog box of instructions, the menu that appears, and the output when the user selects option 3.



**Figure 12-40** Typical execution of the `PlanMenu` application

7. The `PlanMenu` application works well when you enter a valid menu selection. One way that you can force an `Exception` is to enter an invalid menu selection at the prompt. Run the `PlanMenu` application again, and type `4`, `A`, or any invalid value at the prompt. Entering `4` produces an `ArrayIndexOutOfBoundsException`, and entering `A` produces a `NumberFormatException`. If the program lacked the `try...catch` pair, either entry would halt the program. However, because the `setGuestChoice()` method in the `PickMenu` class throws the `Exception` and the `PlanMenu` application catches it, `guestChoice` takes on the value “an invalid selection” and the application ends smoothly, as shown in Figure 12-41.



**Figure 12-41** Exceptional execution of the `PlanMenu` application

## Extending a Class That Throws Exceptions

An advantage to using object-oriented `Exception` handling techniques is that you gain the ability to handle error conditions differently within each program you write. Next, you will extend the `Menu` class to create a class named `VegetarianMenu`. Subsequently, when you write an application that uses `PickMenu` with a `VegetarianMenu` object, you can deal with any thrown `Exception` differently than when you wrote the `PlanMenu` application.

### To create the `VegetarianMenu` class:

1. Open the `Menu.java` file in your text editor, and change the access specifier for the `entreeChoice` array from `private` to `protected`. That way, when you extend the class, the derived class will have access to the array. Save the file and recompile it using the `javac` command.
2. Open a new file in your text editor, and then type the following class header for the `VegetarianMenu` class that extends `Menu`:

```
public class VegetarianMenu extends Menu
{
```

3. Provide new menu choices for the `VegetarianMenu` as follows:

```
String[] vegEntreeChoice = {"Spinach Lasagna",
    "Cheese Enchiladas", "Fruit Plate"};
```

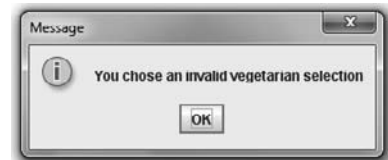
4. Add the following constructor that calls the superclass constructor and assigns each vegetarian selection to the `Menu` superclass `entreeChoice` array, and then add the closing curly brace for the class:

```
public VegetarianMenu()
{
    super();
    for(int x = 0; x < vegEntreeChoice.length; ++x)
        entreeChoice[x] = vegEntreeChoice[x];
}
}
```

5. Save the class as **VegetarianMenu.java**, and then compile it.
6. Now write an application that uses `VegetarianMenu`. You could write any program, but for demonstration purposes, you can simply modify `PlanMenu.java`. Open the **PlanMenu.java** file in your text editor, then immediately save it as **PlanVegetarianMenu.java**.
7. Change the class name in the header to **PlanVegetarianMenu**.
8. Change the first statement within the `main()` method as follows so it declares a `VegetarianMenu` instead of a `Menu`:  

```
VegetarianMenu briefMenu = new VegetarianMenu();
```
9. Change the `guestChoice` assignment statement in the catch block as follows so it is specific to the program that uses the `VegetarianMenu`:  

```
guestChoice = "an invalid vegetarian selection";
```
10. Save the file, compile it, and run the application. When you see the vegetarian menu, enter a valid selection and confirm that the program works correctly. Run the application again and enter an invalid selection. The error message shown in Figure 12-42 identifies your invalid entry as “an invalid vegetarian selection”. Remember that you did not change the `PickMenu` class. Your new `PlanVegetarianMenu` application uses the `PickMenu` class that you wrote and compiled before a `VegetarianMenu` ever existed. However, because `PickMenu` throws uncaught `Exceptions`, you can handle those `Exceptions` as you see fit in any new applications in which you catch them. Click **OK** to end the application.



**Figure 12-42** Output of the `PlanVegetarianMenu` application when the user makes an invalid selection

## You Do It

### Creating an Exception Class

Besides using the built-in `Exceptions` such as `NumberFormatException` and `IndexOutOfBoundsException`, you can create your own `Exception` classes. For example, suppose that although you have asked a user to type a number representing a menu selection, you realize that some users might mistakenly type the initial letter of an option, such as *R* for *Rosemary Chicken*. Although the user has made an error, you want to treat this type of error more leniently than other errors, such as typing a letter that has no discernable connection to the presented menu. In the next section, you will create a `MenuException` class that you can use with the `Menu` class to represent a specific type of error.

### To create the `MenuException` class:

1. Open a new file in your text editor, and enter the `MenuException` class. The class extends `Exception`. Its constructor requires a `String` argument, which is passed to the parent class to be used as a return value for the `getMessage()` method.

```
public class MenuException extends Exception
{
    public MenuException(String choice)
    {
        super(choice);
    }
}
```

2. Save the file as `MenuException.java` and compile it.

## Using an Exception You Created

Next, you will modify the `Menu`, `PickMenu`, and `PlanMenu` classes to demonstrate how to use a `MenuException` object.

### To modify the `Menu` class to throw a `MenuException` object:

1. Open the `Menu` class in your text editor, and immediately save the file as `Menu2.java`.
2. Change the class name to `Menu2`.
3. At the end of the list of class data fields, add an array of characters that can hold the first letter of each of the entrees in the menu.

```
protected char initial[] = new char[entreeChoice.length];
```

4. At the end of the method header for the `displayMenu()` class, add the following clause:

```
throws MenuException
```

You add this clause because you are going to add code that throws such an exception.

5. Within the `displayMenu()` method, just before the closing curly brace of the `for` loop that builds the menu `String`, add a statement that takes the first character of each `entreeChoice` and stores it in a corresponding element of the `initial` array. At the end of the `for` loop, the `initial` array holds the first character of each available entree.

```
initial[x] = entreeChoice[x].charAt(0);
```

6. After displaying the `JOptionPane` dialog box that displays the menu and receives the user's input, add a loop that compares the first letter of the user's choice to each of the initials of valid menu options. If a match is found, throw a new instance of the `MenuException` class that uses the corresponding entree as its `String` argument. In other words, when this thrown `Exception` is caught by another method, the assumed

entree is the `String` returned by the `getMessage()` method. By placing this test before the call to `parseInt()`, you cause entries of *R*, *B*, or *M* to throw a `MenuException` before they can cause a `NumberFormatException`.

```
for(int y = 0; y < entreeChoice.length; ++y)
    if(input.charAt(0) == initial[y])
        throw (new MenuException(entreeChoice[y]));
```

7. Compare your new class with Figure 12-43, in which all of the changes to the `Menu` class are shaded.

```
import javax.swing.*;
public class Menu2
{
    protected String[] entreeChoice = {"Rosemary Chicken",
        "Beef Wellington", "Maine Lobster"};
    private String menu = "";
    private int choice;
    protected char initial[] = new char[entreeChoice.length];
    public String displayMenu() throws MenuException
    {
        for(int x = 0; x < entreeChoice.length; ++x)
        {
            menu = menu + "\n" + (x + 1) + " for " +
                entreeChoice[x];
            initial[x] = entreeChoice[x].charAt(0);
        }
        String input = JOptionPane.showInputDialog(null,
            "Type your selection, then press Enter." + menu);
        for(int y = 0; y < entreeChoice.length; ++y)
            if(input.charAt(0) == initial[y])
                throw(new MenuException(entreeChoice[y]));
        choice = Integer.parseInt(input);
        return(entreeChoice[choice - 1]);
    }
}
```

**Figure 12-43** The `Menu2` class

8. Save the class and compile it.

### To modify the `PickMenu` class to throw a `MenuException` object:

1. Open the `PickMenu` file in your text editor, and immediately save it as `PickMenu2.java`.
2. Change the class name to `PickMenu2` and change the declaration of the `Menu` object to a `Menu2` object. Change the constructor name to `PickMenu2` and its argument to type `Menu2`. Also add a `throws` clause to the `PickMenu2` constructor header so that it throws a `MenuException`. This constructor does not throw an `Exception` directly, but

it calls the `setGuestChoice()` method, which calls the `displayMenu()` method, which throws a `MenuException`.

3. Add the following `throws` clause to the `setGuestChoice()` method header:

**throws MenuException**

4. Compare your modifications to the `PickMenu2` class in Figure 12-44, in which the changes from the `PickMenu` class are shaded. Save your file and compile it.

566

```
import javax.swing.*;
public class PickMenu2
{
    private Menu2 briefMenu;
    private String guestChoice = new String();
    public PickMenu2(Menu2 theMenu) throws MenuException
    {
        briefMenu = theMenu;
        setGuestChoice();
    }
    public void setGuestChoice() throws MenuException
    {
        String inputString = new String();
        JOptionPane.showMessageDialog(null,
            "Choose from the following menu:");
        guestChoice = briefMenu.displayMenu();
    }
    public String getGuestChoice()
    {
        return(guestChoice);
    }
}
```

Figure 12-44 The `PickMenu2` class

### To modify the `PlanMenu` class to handle a `MenuException` object:

1. Open the `PlanMenu.java` file in your text editor, and immediately save it as `PlanMenu2.java`.
2. Change the class name to `PlanMenu2`. Within the `main()` method, declare a `Menu2` object and a `PickMenu2` reference instead of the current `Menu` object and `PickMenu` reference.
3. Within the try block, change both references of `PickMenu` to `PickMenu2`.

Using Figure 12-45 as a reference, add a catch block after the try block and before the existing catch block. This catch block will catch any thrown `MenuExceptions` and display their messages. The message will be the name of a menu item, based on the initial the user entered. All other `Exceptions`, including `NumberFormatExceptions`



and `IndexOutOfBoundsException`, will fall through to the second catch block and be handled as before.

```
import javax.swing.*;
public class PlanMenu2
{
    public static void main(String[] args)
    {
        Menu2 briefMenu = new Menu2();
        PickMenu2 entree = null;
        String guestChoice = new String();
        try
        {
            PickMenu2 selection = new PickMenu2(briefMenu);
            entree = selection;
            guestChoice = entree.getGuestChoice();
        }
        catch(MenuException error)
        {
            guestChoice = error.getMessage();
        }
        catch(Exception error)
        {
            guestChoice = "an invalid selection";
        }
        JOptionPane.showMessageDialog(null,
            "You chose " + guestChoice);
    }
}
```

**Figure 12-45** The `PlanMenu2` class

4. Save the file, then compile and execute it several times. When you are asked to make a selection, try entering a valid number, an invalid number, an initial letter that is part of the menu, and a letter that is not one of the initial menu letters, and observe the results each time. Whether you enter a valid number or not, the application works as expected. Entering an invalid number still results in an error message. When you enter a letter or a string of letters, the application assumes your selection is valid if you enter the same initial letter, using the same case, as one of the menu options.

## Don't Do It

- Don't forget that all the statements in a `try` block might not execute. If an exception is thrown, no statements after that point in the `try` block will execute.
- Don't forget to place more specific catch blocks before more general ones.

- Don't forget to write a `throws` clause for a method that throws a checked exception but does not handle it.
- Don't forget to handle any checked exception thrown to your method either by writing a catch block or by listing it in your method's `throws` clause.

## Key Terms

An **exception** is an unexpected or error condition.

**Exception handling** is an object-oriented technique for managing errors.

**Runtime exceptions** are unplanned exceptions that occur during a program's execution. The term is also used more specifically to describe members of the `RuntimeException` class.

The **Error class** represents more serious errors than the `Exception` class—those from which your program usually cannot recover.

The **Exception class** comprises less serious errors than those from the `Error` class; the `Exception` class represents unusual conditions that arise while a program is running, and from which the program can recover.

A **stack trace history list**, or more simply a **stack trace**, displays all the methods that were called during program execution.

The term **mission critical** refers to any process that is crucial to an organization.

**Fault-tolerant** applications are designed so that they continue to operate, possibly at a reduced level, when some part of the system fails.

**Robustness** represents the degree to which a system is resilient to stress, maintaining correct functioning.

When you create a segment of code in which something might go wrong, you place the code in a **try block**, which is a block of code you attempt to execute while acknowledging that an exception might occur.

A **catch block** is a segment of code that can handle an exception that might be thrown by the try block that precedes it.

A **throw statement** is one that sends an `Exception` out of a block or a method so it can be handled elsewhere.

When you have actions you must perform at the end of a `try...catch` sequence, you can use a **finally block**.

**Exception specification** is the practice of using the keyword `throws` followed by an `Exception` type in the method header. If a method throws a checked `Exception` that it will not catch but that will be caught by a different method, you must use an exception specification.

**Unchecked exceptions** are those from which an executing program cannot reasonably be expected to recover.

**Checked exceptions** are those that a programmer should plan for and from which a program should be able to recover.

The **catch or specify requirement** is the Java rule that checked exceptions require catching or declaration.

**Syntactic sugar** is a term to describe aspects of a computer language that make it “sweeter,” or easier, for programmers to use.

**Syntactic salt** describes a language feature designed to make it harder to write bad code.

The memory location known as the **call stack** is where the computer stores the list of method locations to which the system must return.

An **assertion** is a Java language feature that can help you detect logic errors and debug a program.

You use an **assert statement** to create an assertion.

## Chapter Summary

- An exception is an unexpected or error condition. Exception handling is the name for the object-oriented techniques that manage such errors. In Java, the two basic classes of errors are `Error` and `Exception`; both descend from the `Throwable` class.
- In object-oriented terminology, you “try” a procedure that might cause an error. A method that detects an error condition or `Exception` “throws an exception,” and the block of code that processes the error “catches the exception.” A `try` block is a block of code you attempt to execute while acknowledging that an exception might occur. You must code at least one `catch` block immediately following a `try` block (or else you must code a `finally` block). A `catch` block is a segment of code that can handle an exception that might be thrown by the `try` block that precedes it.
- You can place as many statements as you need within a `try` block, and you can catch as many `Exceptions` as you want. If you try more than one statement, only the first error-generating statement throws an `Exception`. As soon as the `Exception` occurs, the logic transfers to the `catch` block, which leaves the rest of the statements in the `try` block unexecuted. When a program contains multiple `catch` blocks, they are examined in sequence until a match is found for the type of `Exception` that occurred. Then, the matching `catch` block executes and each remaining `catch` block is bypassed.
- When you have actions you must perform at the end of a `try...catch` sequence, you can use a `finally` block. The code within a `finally` block executes regardless of whether the preceding `try` block identifies an `Exception`. Usually, you use a `finally` block to perform cleanup tasks that must happen whether or not any `Exceptions` occurred, and whether or not any `Exceptions` that occurred were caught.

- Besides clarity, an advantage to object-oriented exception handling is the flexibility it allows in the handling of error situations. Each calling application might need to handle the same error differently, depending on its purpose.
- When you write a method that might throw a checked `Exception` that is not caught within the method, you must type the clause `throws <name>Exception` after the method header to indicate the type of `Exception` that might be thrown. Methods in which you explicitly throw a checked exception require a `catch` or a declaration.
- The memory location known as the call stack is where the computer stores the list of method locations to which the system must return. When you catch an `Exception`, you can call `printStackTrace()` to display a list of methods in the call stack so you can determine the location of the `Exception`.
- Java provides over 40 categories of `Exceptions` that you can use in your programs. However, Java's creators could not predict every condition that might be an `Exception` in your applications, so Java also allows you to create your own `Exceptions`. To create your own throwable `Exception`, you must extend a subclass of `Throwable`.
- An assertion is a Java language feature that can help you detect logic errors and debug a program. When you use an assertion, you state a condition that should be true, and Java throws an `AssertionError` when it is not.

## Review Questions

1. In object-oriented programming terminology, an unexpected or error condition is a(n) \_\_\_\_\_.
  - a. anomaly
  - b. aberration
  - c. deviation
  - d. exception
2. All Java `Exceptions` are \_\_\_\_\_.
  - a. `Errors`
  - b. `RuntimeExceptions`
  - c. `Throwables`
  - d. `Omissions`
3. Which of the following statements is true?
  - a. `Exceptions` are more serious than `Errors`.
  - b. `Errors` are more serious than `Exceptions`.
  - c. `Errors` and `Exceptions` are equally serious.
  - d. `Exceptions` and `Errors` are the same thing.
4. The method that ends the current application and returns control to the operating system is \_\_\_\_\_.
  - a. `System.end()`
  - b. `System.done()`
  - c. `System.exit()`
  - d. `System.abort()`

5. In object-oriented terminology, you \_\_\_\_\_ a procedure that might not complete correctly.
  - a. try
  - b. catch
  - c. handle
  - d. encapsulate
6. A method that detects an error condition or Exception \_\_\_\_\_ an Exception.
  - a. throws
  - b. catches
  - c. handles
  - d. encapsulates
7. A try block includes all of the following elements except \_\_\_\_\_.
  - a. the keyword try
  - b. the keyword catch
  - c. curly braces
  - d. statements that might cause Exceptions
8. The segment of code that handles or takes appropriate action following an exception is a \_\_\_\_\_ block.
  - a. try
  - b. catch
  - c. throws
  - d. handles
9. You \_\_\_\_\_ within a try block.
  - a. must place only a single statement
  - b. can place any number of statements
  - c. must place at least two statements
  - d. must place a catch block
10. If you include three statements in a try block and follow the block with three catch blocks, and the second statement in the try block throws an Exception, then \_\_\_\_\_.
  - a. the first catch block executes
  - b. the first two catch blocks execute
  - c. only the second catch block executes
  - d. the first matching catch block executes
11. When a try block does not generate an Exception and you have included multiple catch blocks, \_\_\_\_\_.
  - a. they all execute
  - b. only the first one executes
  - c. only the first matching one executes
  - d. no catch blocks execute

12. The catch block that begins `catch(Exception e)` can catch Exceptions of type \_\_\_\_\_.
  - a. `IOException`
  - b. `ArithmeticException`
  - c. both of the above
  - d. none of the above
13. The code within a `finally` block executes when the `try` block \_\_\_\_\_.
  - a. identifies one or more Exceptions
  - b. does not identify any Exceptions
  - c. either a or b
  - d. neither a nor b
14. An advantage to using a `try...catch` block is that exceptional events are \_\_\_\_\_.
  - a. eliminated
  - b. reduced
  - c. integrated with regular events
  - d. isolated from regular events
15. Which methods can throw an Exception?
  - a. methods with a `throws` clause
  - b. methods with a catch block
  - c. methods with both a `throws` clause and a catch block
  - d. any method
16. A method can \_\_\_\_\_.
  - a. check for errors but not handle them
  - b. handle errors but not check for them
  - c. either of the above
  - d. neither of the above
17. Which of the following is least important to know if you want to be able to use a method to its full potential?
  - a. the method's return type
  - b. the type of arguments the method requires
  - c. the number of statements within the method
  - d. the type of Exceptions the method throws
18. The memory location where the computer stores the list of method locations to which the system must return is known as the \_\_\_\_\_.
  - a. registry
  - b. call stack
  - c. chronicle
  - d. archive

19. You can get a list of the methods through which an `Exception` has traveled by using the \_\_\_\_\_ method.
- a. `getMessage()`
  - b. `callStack()`
  - c. `getPath()`
  - d. `printStackTrace()`
20. A(n) \_\_\_\_\_ is a statement used in testing programs that should be true; if it is not true, an `Exception` is thrown.
- a. assertion
  - b. throwable
  - c. verification
  - d. declaration

## Exercises

1. Write an application named `GoTooFar` in which you declare an array of five integers and store five values in the array. Write a `try` block in which you loop to display each successive element of the array, increasing a subscript by 1 on each pass through the loop. Create a `catch` block that catches the eventual `ArrayIndexOutOfBoundsException` and displays the message, "Now you've gone too far." Save the file as **`GoTooFar.java`**.
2. The `Integer.parseInt()` method requires a `String` argument, but fails if the `String` cannot be converted to an integer. Write an application in which you try to parse a `String` that does not represent an integer value. Catch the `NumberFormatException` that is thrown, and then display an appropriate error message. Save the file as **`TryToParseString.java`**.
3. Write an application that prompts the user to enter a number to use as an array size, and then attempt to declare an array using the entered size. If the array is created successfully, display an appropriate message. Java generates a `NegativeArraySizeException` if you attempt to create an array with a negative size, and Java creates a `NumberFormatException` if you attempt to create an array using a nonnumeric value for the size. Use a `catch` block that executes if the array size is nonnumeric or negative, displaying a message that indicates the array was not created. Save the file as **`NegativeArray.java`**.
4. Write an application that throws and catches an `ArithmeticException` when you attempt to take the square root of a negative value. Prompt the user for an input value and try the `Math.sqrt()` method on it. The application either displays the square root or catches the thrown `Exception` and displays an appropriate message. Save the file as **`SqrtException.java`**.
5. Create an `EmployeeException` class whose constructor receives a `String` that consists of an employee's ID and pay rate. Save the file as **`EmployeeException.java`**. Create an `Employee` class with two fields, `idNum` and `hourlyWage`. The `Employee` constructor requires values for both fields. Upon construction, throw an `EmployeeException` if the `hourlyWage` is less than \$6.00 or over \$50.00. Save the class as **`Employee.java`**. Write an application that establishes at least three `Employees` with `hourlyWages` that are above,

below, and within the allowed range. Display an appropriate message when an `Employee` is successfully created and when one is not. Save the file as **ThrowEmployee.java**.

6.
  - a. Create an `IceCreamConeException` class whose constructor receives a `String` that consists of an ice cream cone's flavor and an integer representing the number of scoops in the `IceCreamCone`. Pass this `String` to the `IceCreamConeException`'s parent so it can be used in a `getMessage()` call. Save the class as **IceCreamConeException.java**. Create an `IceCreamCone` class with two fields—`flavor` and `scoops`. The `IceCreamCone` constructor calls two data-entry methods—`setFlavor()` and `setScoops()`. The `setScoops()` method throws an `IceCreamConeException` when the scoop quantity exceeds three. Save the class as **IceCreamCone.java**. Write an application that establishes several `IceCreamCone` objects and handles the `Exceptions`. Save the file as **ThrowIceCream.java**.
  - b. Create an `IceCreamCone2` class in which you modify the `IceCreamCone` `setFlavor()` method to ensure that the user enters a valid flavor. Allow at least four flavors of your choice. If the user's entry does not match a valid flavor, throw an `IceCreamConeException`. Write an application that establishes several `IceCreamCone` objects and demonstrates the handling of the new `Exception`. Save the new class file as **IceCreamCone2.java** and save the new application file as **ThrowIceCream2.java**.
7. Write an application that displays a series of at least five student ID numbers (that you have stored in an array) and asks the user to enter a numeric test score for the student. Create a `ScoreException` class, and throw a `ScoreException` for the class if the user does not enter a valid score (less than or equal to 100). Catch the `ScoreException` and then display an appropriate message. In addition, store a `0` for the student's score. At the end of the application, display all the student IDs and scores. Save the files as **ScoreException.java** and **TestScore.java**.
8. Write an application that displays a series of at least 10 student ID numbers (that you have stored in an array) and asks the user to enter a test letter grade for the student. Create an `Exception` class named `GradeException` that contains a `static public` array of valid grade letters ('A', 'B', 'C', 'D', 'F', and 'I'), which you can use to determine whether a grade entered from the application is valid. In your application, throw a `GradeException` if the user does not enter a valid letter grade. Catch the `GradeException` and then display an appropriate message. In addition, store an 'I' (for Incomplete) for any student for whom an exception is caught. At the end of the application, display all the student IDs and grades. Save the files as **GradeException.java** and **TestGrade.java**.
9. Create a `DataEntryException` class whose `getMessage()` method returns information about invalid integer data. Write a program named `GetIDAndAge` that continually prompts the user for an ID number and an age until a terminal `0` is entered for both. Throw a `DataEntryException` if the ID is not in the range of valid ID numbers (0 through 999), or if the age is not in the range of valid ages (0 through 119). Catch any `DataEntryException` or `InputMismatchException` that is thrown, and



display an appropriate message. Save the files as **DataEntryException.java** and **GetIDAndAge.java**.

10. A company accepts user orders by part numbers interactively. Users might make the following errors as they enter data:
- ♦ The part number is not numeric.
  - ♦ The quantity is not numeric.
  - ♦ The part number is too low (less than 0).
  - ♦ The part number is too high (more than 999).
  - ♦ The quantity ordered is too low (less than 1).
  - ♦ The quantity ordered is too high (more than 5,000).

Create a class that stores an array of usable error messages; save the file as **DataMessages.java**. Create a **DataException** class; each object of this class will store one of the messages. Save the file as **DataException.java**. Create an application that prompts the user for a part number and quantity. Allow for the possibility of nonnumeric entries as well as out-of-range entries, and display the appropriate message when an error occurs. If no error occurs, display the message “Valid entry”. Save the program as **PartAndQuantityEntry.java**.

11. A company accepts user orders for its products interactively. Users might make the following errors as they enter data:
- ♦ The item number ordered is not numeric.
  - ♦ The quantity is not numeric.
  - ♦ The item number is too low (less than 0).
  - ♦ The item number is too high (more than 9999).
  - ♦ The quantity ordered is too low (less than 1).
  - ♦ The quantity ordered is too high (more than 12).
  - ♦ The item number is not a currently valid item.

Although the company might expand in the future, its current inventory consists of the items shown in Table 12-1.

Item Number	Price (\$)
111	0.89
222	1.47
333	2.43
444	5.99

**Table 12-1** Company inventory

Create a class that stores an array of usable error messages; save the file as **OrderMessages.java**. Create an `OrderException` class that stores one of the messages; save the file as **OrderException.java**. Create an application that contains prompts for an item number and quantity. Allow for the possibility of nonnumeric entries as well as out-of-range entries and entries that do not match any of the currently available item numbers. The program should display an appropriate message if an error has occurred. If no errors exist in the entered data, compute the user's total amount due (quantity times price each) and display it. Save the program as **PlaceAnOrder.java**.

12. a. Gadgets by Mail sells many interesting items through its catalogs. Write an application that prompts the user for order details, including item numbers and quantity of each item ordered, based on the available items shown in Table 12-2.

Item Number	Description	Price (\$)
101	Electric hand warmer	12.99
124	Battery-operated plant waterer	7.55
256	Gerbil trimmer	9.99
512	Talking bookmark	6.89

**Table 12-2** Items offered by Gadgets by Mail

The shipping and handling fee for an order is based on the total order price, as shown in Table 12-3.

Price of Order (\$)	Shipping and Handling (\$)
0–24.99	5.55
25.00–49.99	8.55
50.00 or more	11.55

**Table 12-3** Shipping and handling fees charged by Gadgets by Mail

Create the following classes:

- ♦ `Gadget`, which contains an item number, description, and price for a gadget; a constructor that sets all the fields; and get methods to retrieve the field values.
- ♦ `Order`, which contains an order number, customer name, and address (assume you need just a street address, not city, state, and zip code); a list of item numbers ordered (up to four); the total price of all items ordered; and a

shipping and handling fee for the order. Include a constructor to set the field values and get methods to retrieve the field values.

- ♦ **GadgetOrderTaker**, which is an interactive application that takes four customer orders. The class contains an array of the four **Gadget** objects offered (from Table 12-2). The application prompts each user for a name and street address and assigns a unique order number to each customer, starting with 101. The application asks each user to enter an item number and quantity wanted. When the user enters 999 for the item number, the order is complete, and the next customer can enter data. Each customer can order up to four item numbers. When a customer's order is complete (the customer has entered 999 for an item number, or has ordered four different items), calculate the shipping and handling charges. After four customers have placed **Orders**, display each **Order**'s data, including the order number, the name and address of the customer, and the list of items ordered, including the item number, description, and price of each **Order**, the total price for the order, and the shipping and handling charge. The **GadgetOrderTaker** class handles all thrown **Exceptions** by displaying an explanatory message and ending the application.
- ♦ **OrderException**, which is an **Exception** that is created and thrown under any of the following conditions:
  - ♦ A customer attempts to order more than four different items.
  - ♦ A customer orders more than 100 of any item.
  - ♦ A customer enters an invalid item number.
- ♦ Also, catch the **Exception** generated by either of these conditions:
  - ♦ A customer enters a nonnumeric character as the item number.
  - ♦ A customer enters a nonnumeric character as the quantity.

Save the files as **Gadget.java**, **Order.java**, **GadgetOrderTaker.java**, and **OrderException.java**.

- b. The **GadgetOrderTaker** class handles all thrown **Exceptions** by displaying an explanatory message and ending the application. Create a new application that handles all **Exceptions** by requiring the user to reenter the offending data. Save the file as **GadgetOrderTaker2.java**.



### Debugging Exercise

13. Each of the following files in the Chapter.12 folder of your downloadable student files has syntax and/or logic errors. In each case, determine the problem and fix the program. After you correct the errors, save each file using the same filename preceded with **Fix**. For example, **DebugTwelve1.java** will become **FixDebugTwelve1.java**.

You will also use a file named `DebugEmployeeIDException.java` with the `DebugTwelve4.java` file.

- a. `DebugTwelve1.java`
- b. `DebugTwelve2.java`
- c. `DebugTwelve3.java`
- d. `DebugTwelve4.java`



## Game Zone

14. In Chapter 1, you created a class called `RandomGuess`. In this game, the application generates a random number for a player to guess. In Chapter 5, you improved the application to display a message indicating whether the player's guess was correct, too high, or too low. In Chapter 6, you further improved the game by adding a loop that continually prompts the user to enter the correct value, if necessary. As written, the game should work as long as the player enters numeric guesses. However, if the player enters a letter or other nonnumeric character, the game throws an exception. Discover the type of `Exception` thrown, then improve the game by handling the exception so that the user is informed of the error and allowed to attempt correct data entry again. Save the file as **`RandomGuess4.java`**.
15. In Chapter 8, you created a `Quiz` class that contains an array of 10 multiple-choice questions to which the user was required to respond with an A, B, or C. At the time, you knew how to handle the user's response if an invalid character was entered. Rerun the program now to determine whether an exception is thrown if the user enters nothing—that is, the user just presses the Enter key without making an entry. If so, improve the program by catching the exception, displaying an appropriate error message, and presenting the same question to the user again. Save the file as **`QuizWithExceptionsCaught.java`**.

# File Input and Output

In this chapter, you will:

- ③ Learn about computer files
- ③ Use the `Path` class
- ③ Learn about file organization, streams, and buffers
- ③ Use Java's IO classes to write to and read from a file
- ③ Create and use sequential data files
- ③ Learn about random access files
- ③ Write records to a random access data file
- ③ Read records from a random access data file

## Understanding Computer Files

Data items can be stored on two broad types of storage devices in a computer system:

- **Volatile storage** is temporary; values that are volatile, such as those stored in variables, are lost when a computer loses power. **Random access memory (RAM)** is the temporary storage within a computer. When you write a Java program that stores a value in a variable, you are using RAM. Most computer professionals simply call nonvolatile storage *memory*.
- **Nonvolatile storage** is permanent storage; it is not lost when a computer loses power. When you write a Java program and save it to a disk, you are using permanent storage.



When discussing computer storage, *temporary* and *permanent* refer to volatility, not length of time. For example, a *temporary* variable might exist for several hours in a large program or one that the user forgets to close, but a *permanent* piece of data might be saved and then deleted within a few seconds. In recent years the distinction between memory and storage has blurred because many systems automatically save data to a nonvolatile device and retrieve it after a power interruption. Because you can erase data from files, some programmers prefer the term *persistent storage* to permanent storage. In other words, you can remove data from a file stored on a device such as a disk drive, so it is not technically permanent. However, the data remains in the file even when the computer loses power; so, unlike RAM, the data persists, or perseveres.

A **computer file** is a collection of data stored on a nonvolatile device. Files exist on **permanent storage devices**, such as hard disks, Zip disks, USB drives, reels or cassettes of magnetic tape, and compact discs.

You can categorize files by the way they store data:

- **Text files** contain data that can be read in a text editor because the data has been encoded using a scheme such as ASCII or Unicode. (See Appendix B for more information on Unicode.) Some text files are **data files** that contain facts and figures, such as a payroll file that contains employee numbers, names, and salaries; some files are **program files** or **application files** that store software instructions. You have created many such files throughout this book.
- **Binary files** contain data that has not been encoded as text. Their contents are in binary format, which means that you cannot understand them by viewing them in a text editor. Examples include images, music, and the compiled program files with a .class extension that you have created using this book.

Although their contents vary, files have many common characteristics—each file has a size that specifies the space it occupies on a section of disk or other storage device, and each file has a name and a specific time of creation.

Computer files are the electronic equivalent of paper files stored in file cabinets. When you store a permanent file, you can place it in the main or **root directory** of your storage device. If you compare computer storage to using a file cabinet drawer, saving to the root directory is equivalent to tossing a loose document into the drawer. However, for better organization, most office clerks place documents in folders, and most computer users organize their files into **folders** or **directories**. Users also can create folders within folders to form a hierarchy.

A complete list of the disk drive plus the hierarchy of directories in which a file resides is its **path**. For example, the following is the complete path for a Windows file named `Data.txt`, which is saved on the C drive in a folder named `Chapter.13` within a folder named `Java`:

```
C:\Java\Chapter.13\Data.txt
```

In the Windows operating system, the backslash ( `\` ) is the **path delimiter**—the character used to separate path components. In the Solaris (UNIX) operating system, a slash ( `/` ) is used as the delimiter.

When you work with stored files in an application, you typically perform the following tasks:

- Determining whether and where a path or file exists
- Opening a file
- Writing to a file
- Reading from a file
- Closing a file
- Deleting a file

Java provides built-in classes that contain methods to help you with these tasks.

## TWO TRUTHS & A LIE

### Understanding Computer Files

1. An advantage of modern computer systems is that both internal computer memory and disk storage are nonvolatile.
2. Data files contain facts and figures; program files store software instructions that might use data files.
3. A complete list of the disk drive plus the hierarchy of directories in which a file resides is the file's path.

The false statement is #1. Internal computer memory (RAM) is volatile storage; disk storage is nonvolatile.

## Using the Path Class

You use the **Path class** to create objects that contain information about files or directories, such as their locations, sizes, creation dates, and whether they even exist. You can include either of the following statements in a Java program to use the Path class:

```
import java.nio.file.Path;
import java.nio.file.*;
```

The *nio* in `java.nio` stands for *new input/output* because its classes are “new” in that they were developed long after the first Java versions. The `Path` class is brand new in Java 7; it replaces the functionality of the `File` class used in older Java versions. If you search the Web for Java file-handling programs, you will find many that use the older `File` class.

## Creating a Path

To create a `Path`, you first determine the default file system on the host computer by using a statement such as the following:

```
FileSystem fs = FileSystems.getDefault();
```

Notice that this statement creates a `FileSystem` object using the `getDefault()` method in the `FileSystems` class. The statement uses two different classes. The `FileSystem` class, without an ending *s*, is used to instantiate the object. `FileSystems`, with an ending *s*, is a class that contains **factory methods**, which assist in object creation.

After you create a `FileSystem` object, you can define a `Path` using the `getPath()` method with it:

```
Path path = fs.getPath("C:\\Java\\Chapter.13\\Data.txt");
```

Recall that the backslash is used as part of an escape sequence in Java. (For example, ‘\n’ represents a newline character.) So, to enter a backslash as a path delimiter within a string, you must type two backslashes to indicate a single backslash. An alternative is to use the `FileSystem` method `getSeparator()`. This method returns the correct separator for the current operating system. For example, you can create a `Path` that is identical to the previous one:

```
Path filePath = fs.getPath("C:" + fs.getSeparator() + "Java" +  
    fs.getSeparator() + "Chapter.13" + fs.getSeparator() +  
    "Data.txt");
```

Another way to create a `Path` is to use the `Paths` class (notice the name ends with *s*). The `Paths` class is a helper class that eliminates the need to create a `FileSystem` object. The `Paths` class `get()` method calls the `getPath()` method of the default file system without requiring you to instantiate a `FileSystem` object. You can create a `Path` object by using the following statement:

```
Path filePath = Paths.get("C:\\Java\\Chapter.13\\SampleFile.txt");
```

After the `Path` is created, you use its identifier (in this case, `filePath`) to refer to the file and perform operations on it. `C:\Java\Chapter.13\SampleFile.txt` is the full name of a stored file when the operating system refers to it, but the path is known as `filePath` within the application. The idea of a file having one name when referenced by the operating system and a different name within an application is similar to the way a student known as “Arthur” in school might be “Junior” at home. When an application declares a path and you want to use the application with a different file, you would change only the `String` passed to the instantiating method.

Every `Path` is either absolute or relative. An **absolute path** is a complete path; it does not need any other information to locate a file on a system. A **relative path** depends on other path



information. A full path such as `C:\Java\Chapter.13\SampleFile.txt` is an absolute path. A path such as `SampleFile.txt` is relative. When you work with a path that contains only a filename, the file is assumed to be in the same folder as the program using it. Similarly, when you refer to a relative path such as `Chapter.13\SampleFile.txt` (without the drive letter or the top-level Java folder), the `Chapter.13` folder is assumed to be a subfolder of the current directory, and the `SampleFile.txt` file is assumed to be within the folder.



For Microsoft Windows platforms, the prefix of an absolute path name that contains a disk-drive specifier consists of the drive letter followed by a colon. For UNIX platforms, the prefix of an absolute path name is always a forward slash.

## Retrieving Information about a Path

Table 13-1 summarizes several useful `Path` methods. As you have learned with other classes, the `toString()` method is overridden from the `Object` class; it returns a `String` representation of the `Path`. Basically, this is the list of path elements separated by copies of the default separator for the operating system. The `getName()` method returns the last element in a list of path names; frequently this is a filename, but it might be a folder name.

Method	Description
<code>String toString()</code>	Returns the <code>String</code> representation of the <code>Path</code> , eliminating double backslashes
<code>String getName()</code>	Returns the last item in the sequence of name elements
<code>int getNameCount()</code>	Returns the number of name elements in the <code>Path</code>
<code>String getName(int)</code>	Returns the name in the position of the <code>Path</code> specified by the integer parameter
<code>boolean exists()</code>	Returns <code>true</code> if the <code>Path</code> exists
<code>boolean notExists()</code>	Returns <code>true</code> if the <code>Path</code> does not exist
<code>void delete()</code>	Deletes a <code>Path</code> and throws an exception if the <code>Path</code> doesn't exist
<code>void deleteIfExists()</code>	Deletes a <code>Path</code> but throws no exception whether the <code>Path</code> exists or not

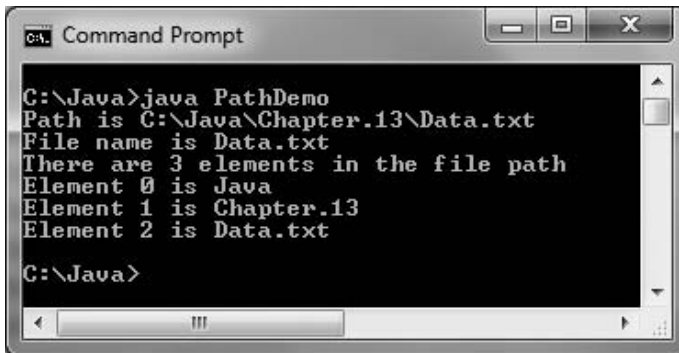
**Table 13-1** Selected `Path` class methods

A `Path`'s elements are accessed using an index. The top-level element in the directory structure is located at index 0; the lowest element in the structure is accessed by the `getName()` method, and has an index that is one less than the number of items on the list. You can use the `getNameCount()` method to retrieve the number of names in the list, and you can use the `getName(int)` method to retrieve the name in the position specified by the argument.

Figure 13-1 shows a demonstration program that creates a `Path` and uses some of the methods in Table 13-1. Figure 13-2 shows the output.

```
import java.nio.file.*;
public class PathDemo
{
    public static void main(String[] args)
    {
        Path filePath =
            Paths.get("C:\\Java\\Chapter.13\\Data.txt");
        int count = filePath.getNameCount();
        System.out.println("Path is " + filePath.toString());
        System.out.println("File name is " + filePath.getName());
        System.out.println("There are " + count +
            " elements in the file path");
        for(int x = 0; x < count; ++x)
            System.out.println("Element " + x + " is " +
                filePath.getName(x));
    }
}
```

Figure 13-1 The `PathDemo` class



```
cmd. Command Prompt
C:\Java>java PathDemo
Path is C:\Java\Chapter.13\Data.txt
File name is Data.txt
There are 3 elements in the file path
Element 0 is Java
Element 1 is Chapter.13
Element 2 is Data.txt
C:\Java>
```

Figure 13-2 Output of the `PathDemo` application

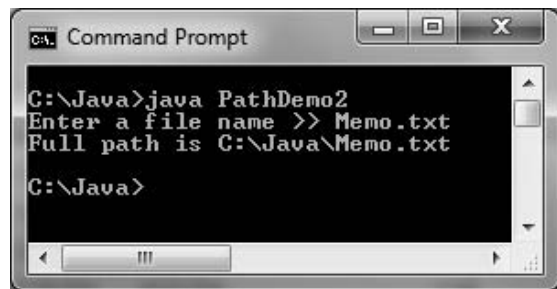
## Converting a Relative Path to an Absolute One

The `toAbsolutePath()` method converts a relative path to an absolute path. For example, Figure 13-3 shows a program that asks a user for a filename and converts it to an absolute path, if necessary.

```
import java.util.Scanner;
import java.nio.file.*;
public class PathDemo2
{
    public static void main(String[] args)
    {
        String name;
        Scanner keyboard = new Scanner(System.in);
        System.out.print("Enter a file name >> ");
        name = keyboard.nextLine();
        Path inputPath = Paths.get(name);
        Path fullPath = inputPath.toAbsolutePath();
        System.out.println("Full path is " + fullPath.toString());
    }
}
```

**Figure 13-3** The PathDemo2 class

When the PathDemo2 program executes, the entered filename might represent only a relative path. If the input represents an absolute Path, the program does not modify the input, but if the input represents a relative Path, the program then creates an absolute path by assigning the file to the current directory. Figure 13-4 shows a typical program execution.



```
C:\Java>java PathDemo2
Enter a file name >> Memo.txt
Full path is C:\Java\Memo.txt
C:\Java>
```

**Figure 13-4** Output of the PathDemo2 program

## Checking File Accessibility

To verify that a file exists and that the program can access it as needed, you can use the `checkAccess()` method. The following `import` statement allows you to access constants that can be used as arguments to the method:

```
import static java.nio.file.AccessMode.*;
```

You can use any of the following as arguments to the `checkAccess()` method:

- No argument—Checks that the file exists; you can substitute the `exists()` method for a `checkAccess()` call that uses no arguments
- `READ`—Checks that the file exists and that the program has permission to read the file
- `WRITE`—Checks that the file exists and that the program has permission to write to the file
- `EXECUTE`—Checks that the file exists and that the program has permission to execute the file



Java's **static import feature** takes effect when you place the keyword `static` between `import` and the name of the package being imported. This feature allows you to use `static` constants without their class name. For example, if you remove `static` from the `import` statement for `java.nio.file.AccessMode`, you must refer to the `READ` constant by its full name as `AccessMode.READ`; when you use `static`, you can refer to it just as `READ`.

You can use multiple arguments to `checkAccess()`, separated by commas. If the file cannot be accessed as indicated in the method call, an `IOException` is thrown. (Notice in Figure 13-5 that the `java.io.IOException` package must be imported because an `IOException` might be instantiated and thrown.) Figure 13-5 shows an application that declares a `Path` and checks whether the file can be read and executed. Figure 13-6 shows the output.

```
import java.nio.file.*;
import static java.nio.file.AccessMode.*;
import java.io.IOException;
public class PathDemo3
{
    public static void main(String[] args)
    {
        Path filePath =
            Paths.get("C:\\Java\\Chapter.13\\Data.txt");
        System.out.println("Path is " + filePath.toString());
        try
        {
            filePath.checkAccess(READ, EXECUTE);
            System.out.println("File can be read and executed");
        }
        catch (IOException e)
        {
            System.out.println
                ("File cannot be used for this application");
        }
    }
}
```

Figure 13-5 The PathDemo3 class

```
C:\Java>java PathDemo3
Path is C:\Java\Chapter.13\Data.txt
File can be read and executed
C:\Java>_
```

Figure 13-6 Output of the PathDemo3 application



A program might find a file usable, but then the file might become unusable before it is actually used in a later statement. This kind of program bug is called a **TOCTTOU bug** (pronounced *tock too*)—it happens when changes occur from Time Of Check To Time Of Use.

## Deleting a Path

The `Path` class `delete()` method deletes a file or throws an exception if the deletion fails. For example:

- If you try to delete a file that does not exist, a `NoSuchFileException` is thrown.
- A directory cannot be deleted unless it is empty. If you attempt to delete a directory that contains files, a `DirectoryNotEmptyException` is thrown.
- If you try to delete a file but you don't have permission, an `IOException` is thrown.

Figure 13-7 shows a program that displays an appropriate message in each of the preceding scenarios after attempting to delete a file.

```
import java.nio.file.*;
import java.io.IOException;
public class PathDemo4
{
    public static void main(String[] args)
    {
        Path filePath =
            Paths.get("C:\\Java\\Chapter.13\\Data.txt");
        try
        {
            filePath.delete();
            System.out.println("File or directory is deleted");
        }
        catch (NoSuchFileException e)
        {
            System.out.println("No such file or directory");
        }
        catch (DirectoryNotEmptyException e)
        {
            System.out.println("Directory is not empty");
        }
        catch (IOException e)
        {
            System.out.println("No permission to delete");
        }
    }
}
```

**Figure 13-7** The `PathDemo4` class

The `deleteIfExists()` method also can be used to delete a file, but if the file does not exist, no exception is thrown. If you want a file to be gone, you are satisfied whether you delete it or it already has been deleted, so you might have no need for exception handling.

## Determining File Attributes

588

You can use the `readBasicFileAttributes()` method of the `Attributes` class to retrieve useful information about a file. The method takes a `Path` argument and returns an instance of the `BasicFileAttributes` class. You might create an instance with a statement such as the following:

```
BasicFileAttributes attr =
    Attributes.readBasicFileAttributes(filePath);
```

After you have created a `BasicFileAttributes` object, you can use a number of methods for retrieving information about a file. For example, the `size()` method returns the size of a file in bytes. Methods such as `creationTime()` and `lastModifiedTime()` return important file times. Figure 13-8 contains a program that uses these methods.

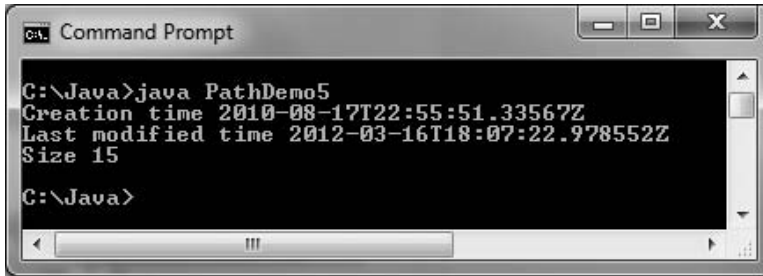
```
import java.nio.file.*;
import java.nio.file.attribute.*;
import java.nio.file.attribute.Attributes;
import java.io.IOException;
public class PathDemo5
{
    public static void main(String[] args)
    {
        Path filePath =
            Paths.get("C:\\Java\\Chapter.13\\Data.txt");
        try
        {
            BasicFileAttributes attr =
                Attributes.readBasicFileAttributes(filePath);
            System.out.println("Creation time " + attr.creationTime());
            System.out.println("Last modified time " +
                attr.lastModifiedTime());
            System.out.println("Size " + attr.size());
        }
        catch (IOException e)
        {
            System.out.println("IO Exception");
        }
    }
}
```

**Figure 13-8** The `PathDemo5` class

The time methods in the `PathDemo5` program each return a `FileTime` object that is converted to a `String` in the `println()` method calls. `FileTime` objects are represented in the following format:

yyyy-mm-ddThh:mm:ss

In a `FileTime` object, the four-digit year is followed by the two-digit month and two-digit day. Following a *T* for *Time*, the hour, minute, and seconds (including fractions of a second) are separated by colons. You can see from the output in Figure 13-9 that the file was created in August 2010 and last modified in March 2012.



```

C:\Java>java PathDemo5
Creation time 2010-08-17T22:55:51.33567Z
Last modified time 2012-03-16T18:07:22.978552Z
Size 15
C:\Java>

```

**Figure 13-9** Output of the PathDemo5 program

Frequently, you don't care about a file's exact `FileTime` value, but you are interested in comparing two files. You can use the `compareTo()` method to determine the time relationships between files. For example, Figure 13-10 shows how you might compare the creation times of two files. As shown in the shaded statement, the `compareTo()` method returns a value of less than 0 if the first `FileTime` comes before the argument's `FileTime`. The method returns a value of greater than 0 if the first `FileTime` is later than the argument's, and it returns 0 if the `FileTime` values are the same.

```

import java.nio.file.*;
import java.nio.file.attribute.*;
import java.nio.file.attribute.Attributes;
import java.io.IOException;
public class PathDemo6
{
    public static void main(String[] args)
    {
        Path file1 =
            Paths.get("C:\\Java\\Chapter.13\\Data.txt");
        Path file2 =
            Paths.get("C:\\Java\\Chapter.13\\Data2.txt");
        try
        {
            BasicFileAttributes attr1 =
                Attributes.readBasicFileAttributes(file1);
            BasicFileAttributes attr2 =
                Attributes.readBasicFileAttributes(file2);
            FileTime time1 = attr1.creationTime();
            FileTime time2 = attr2.creationTime();
            System.out.println("file1's creation time is: " + time1);
            System.out.println("file2's creation time is: " + time2);

```

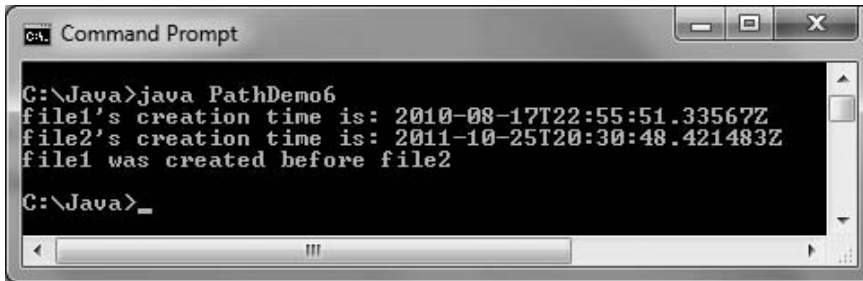
**Figure 13-10** The PathDemo6 class (continues)

(continued)

```
        if(time1.compareTo(time2) < 0)
            System.out.println("file1 was created before file2");
        else
            if(time1.compareTo(time2) > 0)
                System.out.println("file1 was created after file2");
            else
                System.out.println
                    ("file1 and file2 were created at the same time");
    }
    catch (IOException e)
    {
        System.out.println("IO Exception");
    }
}
```

**Figure 13-10** The PathDemo6 class

Figure 13-11 shows the output of the application in Figure 13-10. The file named `file1` was created in August 2010, and `file2` was created in October 2011, so the program correctly determines that `file1` was created first.



```
cmd Command Prompt
C:\Java>java PathDemo6
file1's creation time is: 2010-08-17T22:55:51.33567Z
file2's creation time is: 2011-10-25T20:30:48.421483Z
file1 was created before file2
C:\Java>_
```

**Figure 13-11** Output of the PathDemo6 program



Besides `BasicFileAttributes`, Java supports specialized classes for DOS file attributes used on DOS systems and POSIX file attributes used on systems such as UNIX. For example, DOS files might be *hidden* or *read only* and UNIX files might have a group owner. For more details on specialized file attributes, visit [java.sun.com](http://java.sun.com).



Watch the video *Paths and Attributes*.



## TWO TRUTHS & A LIE

### Using the Path Class

1. Java's Path class is used to create objects that contain information to specify the location of files or directories.
2. A relative path is a complete path; it does not need any other information to locate a file on a system.
3. You can use the `readBasicFileAttributes()` method of the `Attributes` class to retrieve information about a file, such as its size and when it was created.

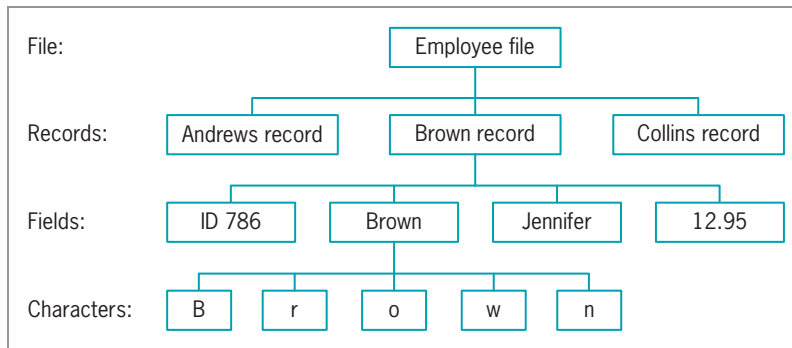
The false statement is #2. A relative path depends on other path information. An absolute path is a complete path; it does not need any other information to locate a file on a system.

591

## File Organization, Streams, and Buffers

Most businesses generate and use large quantities of data every day. You can store data in variables within a program, but such storage is temporary. When the application ends, the variables no longer exist and the data values are lost. Variables are stored in the computer's main or primary memory (RAM). When you need to retain data for any significant amount of time, you must save the data on a permanent, secondary storage device, such as a disk.

Businesses organize data in a hierarchy, as shown in Figure 13-12. The smallest useful piece of data to most users is the character. A **character** can be any letter, number, or special symbol (such as a punctuation mark) that comprises data. Characters are made up of bits (the zeros and ones that represent computer circuitry), but people who use data typically do not care whether the internal representation for an 'A' is 01000001 or 10111110. Rather, they are concerned with the meaning of 'A'—for example, it might represent a grade in a course, a person's initial, or a company code. In computer terminology, a character can be any group of bits, and it does not necessarily represent a letter or number; for example, some "characters" produce a sound or control the display. Also, characters are not necessarily created with a single keystroke; for example, escape sequences are used to create the '\n' character, which starts a new line, and '\\', which represents a single backslash. Sometimes, you can think of a character as a unit of information instead of data with a particular appearance. For example, the mathematical character pi ( $\pi$ ) and the Greek letter pi look the same, but have two different Unicode values.



**Figure 13-12** Data hierarchy

When businesses use data, they group characters into fields. A **field** is a group of characters that has some meaning. For example, the characters *T*, *o*, and *m* might represent your first name. Other data fields might represent items such as last name, Social Security number, zip code, and salary.

Fields are grouped together to form records. A **record** is a collection of fields that contain data about an entity. For example, a person's first and last names, Social Security number, zip code, and salary represent that person's record. When programming in Java, you have created many classes, such as an `Employee` class and a `Student` class. You can think of the data typically stored in each of these classes as a record. These classes contain individual variables that represent data fields. A business's data records usually represent a person, item, sales transaction, or some other concrete object or event.

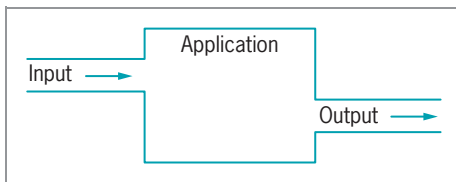
Records are grouped to create files. Data files consist of related records, such as a company's personnel file that contains one record for each company employee. Some files have only a few records; perhaps your professor maintains a file for your class with 25 records—one record for each student. Other files contain thousands or even millions of records. For example, a large insurance company maintains a file of policyholders, and a mail-order catalog company maintains a file of available items. A data file can be used as a **sequential access file** when each record is accessed one after another in the order in which it was stored. Most frequently, each record is stored in order based on the value in some field; for example, employees might be stored in Social Security number order, or inventory items might be stored in item number order. When records are not used in sequence, the file is used as a random access file. You will learn more about random access files later in this chapter.

When records are stored in a data file, their fields can be organized one to a line, or a character can be used to separate them. A file of **comma-separated values (CSV)** is one in which each value in a record is separated from the next with a comma; CSV is a widely used format for files used in all sorts of applications, including databases and spreadsheets. Later in this chapter, you will see examples of CSV files.

Before an application can use a data file, it must open the file. A Java application **opens a file** by creating an object and associating a stream of bytes with it. Similarly, when you finish using a file, the program should **close the file**—that is, make it no longer available to your

application. If you fail to close an input file—a file from which you are reading data—there usually are no serious consequences; the data still exists in the file. However, if you fail to close an output file—a file to which you are writing data—the data might become inaccessible. You should always close every file you open, and usually you should close the file as soon as you no longer need it. When you leave a file open for no reason, you use computer resources and your computer's performance suffers. Also, particularly within a network, another program might be waiting to use the file.

Whereas people view a file as a series of records, with each record containing data fields, Java does not automatically attribute such meaning to a file's contents. Instead, Java simply views a file as a series of bytes. When you perform an input operation in an application, you can picture bytes flowing into your program from an input device through a **stream**, which functions as a pipeline or channel. When you perform output, some bytes flow out of your application through another stream to an output device, as shown in Figure 13-13. A stream is an object, and like all objects, streams have data and methods. The methods allow you to perform actions such as opening, closing, reading, and writing.



**Figure 13-13** File streams

Most streams flow in only one direction; each stream is either an input or output stream. (Random access files use streams that flow in two directions. You will use a random access file later in this chapter.) You might open several streams at once within an application. For example, an application that reads a data disk and separates valid records from invalid ones might require three streams. The data arrives via an input stream, one output stream writes some records to a file of valid records, and another output stream writes other records to a file of invalid records.

Input and output operations are usually the slowest in any computer system because of limitations imposed by the hardware. For that reason, professional programs often employ buffers. A **buffer** is a memory location where bytes are held after they are logically output, but before they are sent to the output device. Using a buffer to accumulate input or output before issuing the actual IO command improves program performance. When you use an output buffer, you sometimes flush it before closing it. **Flushing** clears any bytes that have been sent to a buffer for output, but have not yet been output to a hardware device.



Watch the video *File Organization, Streams, and Buffers*.

## TWO TRUTHS & A LIE

### File Organization, Streams, and Buffers

1. A field is a group of characters that has some meaning; a record is a collection of fields.
2. A data file is used as a sequential access file when the first fields for each record are stored first in the file, the second fields for each record are stored next, and so on.
3. Java views files as a series of bytes that flow into and out of your applications through a stream.

The false statement is #2. A data file is used as a sequential access file when each record is stored in order based on the value in some field.

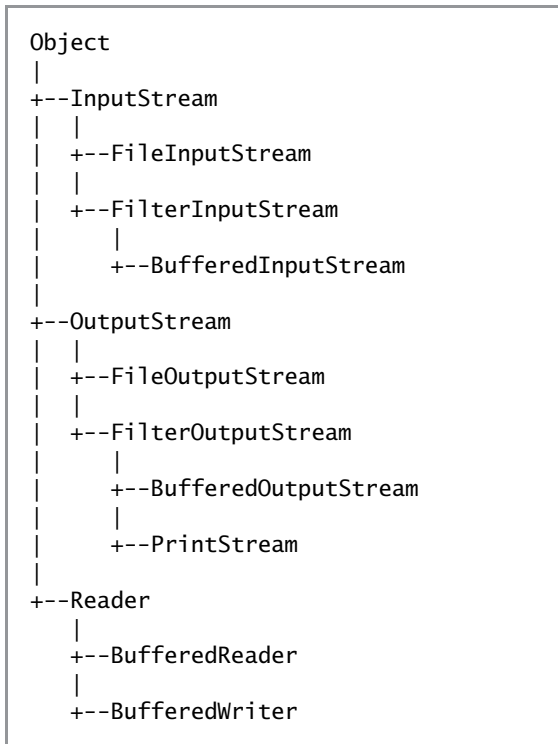
## Using Java's IO Classes

Figure 13-14 shows a partial hierarchical relationship of some of the classes Java uses for input and output (IO) operations; it shows that `InputStream`, `OutputStream`, and `Reader` are subclasses of the `Object` class. All three of these classes are abstract. As you learned in Chapter 11, abstract classes contain methods that must be overridden in their child classes. The figure also shows the major IO child classes that you will study in this chapter. The capabilities of these classes are summarized in Table 13-2.

As its name implies, the `OutputStream` class can be used to produce output. Table 13-3 shows some of the class's common methods. You can use `OutputStream` to write all or part of an array of bytes. When you finish using an `OutputStream`, you usually want to flush and close it.

Java's `System` class contains a `PrintStream` object named `System.out`; you have used this object extensively in the book, along with its `print()` and `println()` methods. Besides `System.out`, the `System` class defines a `PrintStream` object named `System.err`. The output from `System.err` and `System.out` can go to the same device; in fact, `System.err` and `System.out` are both directed by default to the command line on the monitor. The difference is that `System.err` is usually reserved for error messages, and `System.out` is reserved for valid output. You can direct either `System.err` or `System.out` to a new location, such as a disk file or printer. For example, you might want to keep a hard copy (printed) log of the error messages generated by a program, but direct the standard output to a disk file.

Although you usually have no need to do so, you can create your own `OutputStream` object and assign `System.out` to it. Figure 13-15 shows how this works. The application declares a `String` of letter grades allowed in a course. Then, the `getBytes()` method converts the `String` to an array of bytes. An `OutputStream` object is declared, and `System.out` is assigned to the `OutputStream` reference in a try block. The `write()` method accepts the byte array and sends it to the output device, and then the output stream is flushed and closed. Figure 13-16 shows the execution.



**Figure 13-14** Relationship of selected IO classes

Class	Description
<code>InputStream</code>	Abstract class that contains methods for performing input
<code>FileInputStream</code>	Child of <code>InputStream</code> that provides the capability to read from disk files
<code>BufferedInputStream</code>	Child of <code>FilterInputStream</code> , which is a child of <code>InputStream</code> ; <code>BufferedInputStream</code> handles input from a system's standard (or default) input device, usually the keyboard
<code>OutputStream</code>	Abstract class that contains methods for performing output
<code>FileOutputStream</code>	Child of <code>OutputStream</code> that allows you to write to disk files
<code>BufferedOutputStream</code>	Child of <code>FilterOutputStream</code> , which is a child of <code>OutputStream</code> ; <code>BufferedOutputStream</code> handles input from a system's standard (or default) output device, usually the monitor
<code>PrintStream</code>	Child of <code>FilterOutputStream</code> , which is a child of <code>OutputStream</code> ; <code>System.out</code> is a <code>PrintStream</code> object

**Table 13-2** Selected classes used for input and output (continues)

*(continued)*

Class	Description
Reader	Abstract class for reading character streams; the only methods that a subclass must implement are <code>read(char[], int, int)</code> and <code>close()</code>
BufferedReader	Reads text from a character-input stream, buffering characters to provide for efficient reading of characters, arrays, and lines
BufferedWriter	Writes text to a character-output stream, buffering characters to provide for the efficient writing of characters, arrays, and lines

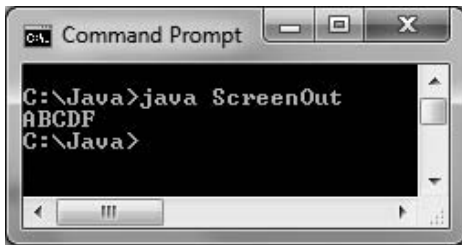
**Table 13-2** Selected classes used for input and output

OutputStream Method	Description
<code>void close()</code>	Closes the output stream and releases any system resources associated with the stream
<code>void flush()</code>	Flushes the output stream; if any bytes are buffered, they will be written
<code>void write(byte[] b)</code>	Writes all the bytes to the output stream from the specified byte array
<code>void write(byte[] b, int off, int len)</code>	Writes bytes to the output stream from the specified byte array starting at offset position <code>off</code> for a length of <code>len</code> characters

**Table 13-3** Selected OutputStream methods

```
import java.io.*;
public class ScreenOut
{
    public static void main(String[] args)
    {
        String s = "ABCDF";
        byte[] data = s.getBytes();
        OutputStream output = null;
        try
        {
            output = System.out;
            output.write(data);
            output.flush();
            output.close();
        }
        catch(Exception e)
        {
            System.out.println("Message: " + e);
        }
    }
}
```

**Figure 13-15** The ScreenOut class



**Figure 13-16** Output of the ScreenOut program

## Writing to a File

The output in Figure 13-16 is not very impressive. Before you knew about streams, you wrote applications that displayed a string on the monitor by using the automatically created `System.out` object, so the application in Figure 13-15 might seem to contain a lot of unnecessary work at first. However, other output devices can be assigned to `OutputStream` references, allowing your applications to save data to them.

Instead of assigning the standard output device to `OutputStream`, you can assign a file. To accomplish this, you can construct a `BufferedOutputStream` object and assign it to the `OutputStream`. If you want to change an application's output device, you don't have to modify the application other than to assign a new object to the `OutputStream`; the rest of the logic remains the same. Java lets you assign a file to a `Stream` object so that screen output and file output work in exactly the same manner.

You can create a writeable file by using the `Path` class `newOutputStream()` method. This method creates a file if it does not already exist, opens the file for writing, and returns an `OutputStream` that can be used to write bytes to the file. Table 13-4 shows the `StandardOpenOption` arguments you can use with the `newOutputStream()` method. If you do not specify any options and the file does not exist, a new file is created. If the file exists, it is truncated. In other words, specifying no option is the same as specifying both `CREATE` and `TRUNCATE_EXISTING`.

<b>StandardOpenOption</b>	<b>Description</b>
WRITE	Opens the file for writing
APPEND	Appends new data to the end of the file; use this option with WRITE or CREATE
TRUNCATE_EXISTING	Truncates the existing file to 0 bytes so the file contents are replaced; use this option with the WRITE option
CREATE_NEW	Creates a new file only if it does not exist; throws an exception if the file already exists
CREATE	Opens the file if it exists or creates a new file if it does not
DELETE_ON_CLOSE	Deletes the file when the stream is closed; used most often for temporary files that exist only for the duration of the program

**Table 13-4** Selected `StandardOpenOption` constants

Figure 13-17 shows an application that writes a `String` of bytes to a file. The only differences from the preceding `ScreenOut` class are shaded in the figure and summarized here:

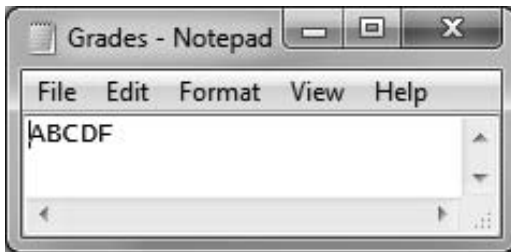
- Additional `import` statements are used.
- The class name is changed.
- A `Path` is declared for a `Grades.txt` file.
- Instead of assigning `System.out` to the `OutputStream` reference, a `BufferedOutputStream` object is assigned.

```
import java.nio.file.*;
import java.io.*;
import static java.nio.file.StandardOpenOption.*;
public class FileOut
{
    public static void main(String[] args)
    {
        Path file =
            Paths.get("C:\\Java\\Chapter.13\\Grades.txt");
        String s = "ABCDF";
        byte[] data = s.getBytes();
        OutputStream output = null;
        try
        {
            output = new
                BufferedOutputStream(file.newOutputStream(CREATE));
            output.write(data);
            output.flush();
            output.close();
        }
        catch (Exception e)
        {
            System.out.println("Message: " + e);
        }
    }
}
```

**Figure 13-17** The `FileOut` class

When the `FileOut` program executes, no output appears on the monitor, but a file is created. Figure 13-18 shows the file when it is opened in Notepad.





**Figure 13-18** Contents of the Grades.txt file created by the FileOut program

## Reading from a File

You use an `InputStream` like you use an `OutputStream`. If you want, you can create an `InputStream`, assign `System.in` to it, and use the class's `read()` method with the created object to retrieve keyboard input. Usually, however, it is more efficient to use the `Scanner` class for keyboard input and to use the `InputStream` class to input data that has been stored in a file.

To open a file for reading, you can use the `newInputStream()` method. This method returns a stream that can read bytes from a file. Figure 13-19 shows a `ReadFile` class that reads from the `Grades.txt` file created earlier. The `Path` is declared and an `InputStream` is declared using the `Path`. Then, in the first shaded statement of the figure, a stream is assigned to the `InputStream` reference.

```
import java.nio.file.*;
import java.io.*;
public class ReadFile
{
    public static void main(String[] args)
    {
        Path file = Paths.get("C:\\Java\\Chapter.13\\Grades.txt");
        InputStream input = null;
        try
        {
            input = file.newInputStream();
            BufferedReader reader = new
                BufferedReader(new InputStreamReader(input));
            String s = null;
            s = reader.readLine();
            System.out.println(s);
            input.close();
        }
        catch (IOException e)
        {
            System.out.println(e);
        }
    }
}
```

**Figure 13-19** The `ReadFile` class



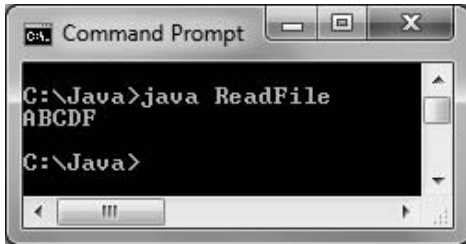
If you needed to read multiple lines from the file in the program in Figure 13-19, you could use a loop such as the following:

```
while ((s = reader.readLine() != null)
    System.out.println(s);
```

This loop continuously reads and displays lines from the file until the `readLine()` method returns `null`, indicating that no more data is available.

600

In the second shaded statement in the `ReadFile` class, a `BufferedReader` is declared. A `BufferedReader` reads a line of text from a character-input stream, buffering characters so that reading is more efficient. Figure 13-20 shows the `ReadFile` program's execution. The `readLine()` method gets the single line of text from the `Grades.txt` file, and then the line is displayed.



**Figure 13-20** Execution of the `ReadFile` program

When you use the `BufferedReader` class, you must import the `java.io` package into your program. Table 13-5 shows some useful `BufferedReader` methods.

<b>BufferedReader Method</b>	<b>Description</b>
<code>close()</code>	Closes the stream and any resources associated with it
<code>read()</code>	Reads a single character
<code>read(char[] buffer, int off, int len)</code>	Reads characters into a portion of an array from position <code>off</code> for <code>len</code> characters
<code>readLine()</code>	Reads a line of text
<code>skip(long n)</code>	Skips the specified number of characters

**Table 13-5** Selected `BufferedReader` methods

**TWO TRUTHS & A LIE****Using Java's IO Classes**

1. Java's `InputStream`, `OutputStream`, and `Reader` classes are used for handling input and output.
2. You can create your own `OutputStream` object, assign `System.out` to it, and use it for writing output to the screen, or you can use the `Path` class `newOutputStream()` method to create a file and open it for writing.
3. To open a file for reading, you can use the `newInputStream()` method to get a stream that can read bytes from a file.

601

The false statement is #3. To open a file for reading, you can use the `newInputStream()` method to get a stream that can read bytes from a file.

## Creating and Using Sequential Data Files

Frequently, you want to save more than a single `String` to a file. For example, you might have a data file of personnel records that include an ID number, name, and pay rate for each employee in your organization. Figure 13-21 shows a program that reads employee ID numbers, names, and pay rates from the keyboard and sends them to a comma-separated file.



In Figure 13-21, notice the extra `nextLine()` call after the employee's ID number is entered. Recall from Chapter 2 that this extra call is necessary to consume the newline character that remains in the input buffer after the ID number is accepted.

The first shaded statement in the `WriteEmployeeFile` program creates a `BufferedWriter` named `writer`. The `BufferedWriter` class is the counterpart to `BufferedReader`. It writes text to an output stream, buffering the characters. The class has three overloaded `write()` methods that provide for efficient writing of characters, arrays, and strings, respectively. Table 13-6 contains all the methods defined in the `BufferedWriter` class.

```
import java.nio.file.*;
import java.io.*;
import static java.nio.file.StandardOpenOption.*;
import java.util.Scanner;
public class WriteEmployeeFile
{
    public static void main(String[] args)
    {
        Scanner input = new Scanner(System.in);
        Path file =
            Paths.get("C:\\Java\\Chapter.13\\Employees.txt");
        String s = "";
        String delimiter = ",";
        int id;
        String name;
        double payRate;
        final int QUIT = 999;
        try
        {
            OutputStream output = new
                BufferedOutputStream(file.newOutputStream(CREATE));
            BufferedWriter writer = new
                BufferedWriter(new OutputStreamWriter(output));
            System.out.print("Enter employee ID number >> ");
            id = input.nextInt();
            while(id != QUIT)
            {
                System.out.print("Enter name for employee #" +
                    id + " >> ");
                input.nextLine();
                name = input.nextLine();
                System.out.print("Enter pay rate >> ");
                payRate = input.nextDouble();
                s = id + delimiter + name + delimiter + payRate;
                writer.write(s, 0, s.length());
                writer.newLine();
                System.out.print("Enter next ID number or " +
                    QUIT + " to quit >> ");
                id = input.nextInt();
            }
            writer.close();
        }
        catch(Exception e)
        {
            System.out.println("Message: " + e);
        }
    }
}
```

**Figure 13-21** The WriteEmployeeFile class

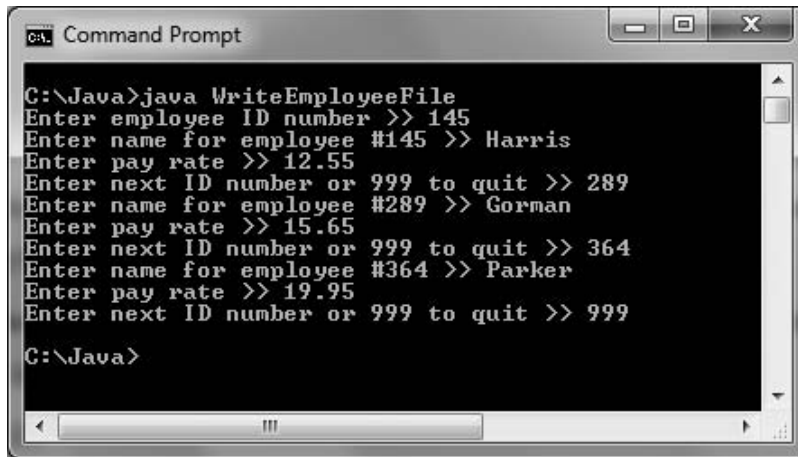
<b>BufferedWriter Method</b>	<b>Description</b>
<code>close()</code>	Closes the stream, flushing it first
<code>flush()</code>	Flushes the stream
<code>newline()</code>	Writes a line separator
<code>write(String s, int off, int len)</code>	Writes a <code>String</code> from position <code>off</code> for length <code>len</code>
<code>write(char[] array, int off, int len)</code>	Writes a character array from position <code>off</code> for length <code>len</code>
<code>write(int c)</code>	Writes a single character

**Table 13-6** BufferedWriter methods

In the `WriteEmployeeFile` program, `Strings` of employee data are constructed within a loop that executes while the user does not enter the `QUIT` value. When a `String` is complete—that is, when it contains an ID number, name, and pay rate separated with commas—the `String` is sent to `writer` in the second shaded statement in the class. The `write()` method accepts the `String` from position 0 for its entire length.

After the `String` is written, the system's newline character is also written. Although a data file would not require a newline character after each record (each new record could be separated with a comma or any other unique character that was not needed as part of the data), adding a new line makes the output file easier for a person to read and interpret. Because not all platforms use `'\n'` to separate lines, the `BufferedWriter` class contains a `newline()` method that uses the current platform's line separator. Alternatively, you could write the value of `System.getProperty("line.separator")`. This method call returns the default line separator for a system; the same separator is supplied either way because the `newline()` method actually calls the `System.getProperty()` method for you.

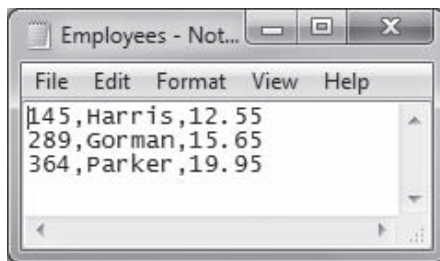
Any of the input or output methods in the `WriteEmployeeFile` program might throw an exception, so all the relevant code in the class is placed in a `try` block. Figure 13-22 shows a typical program execution, and Figure 13-23 shows the output file when it is opened in Notepad.



```
ca. Command Prompt
C:\Java>java WriteEmployeeFile
Enter employee ID number >> 145
Enter name for employee #145 >> Harris
Enter pay rate >> 12.55
Enter next ID number or 999 to quit >> 289
Enter name for employee #289 >> Gorman
Enter pay rate >> 15.65
Enter next ID number or 999 to quit >> 364
Enter name for employee #364 >> Parker
Enter pay rate >> 19.95
Enter next ID number or 999 to quit >> 999

C:\Java>
```

**Figure 13-22** Typical execution of the `WriteEmployeeFile` program



```
Employees - Not...
File Edit Format View Help
145,Harris,12.55
289,Gorman,15.65
364,Parker,19.95
```

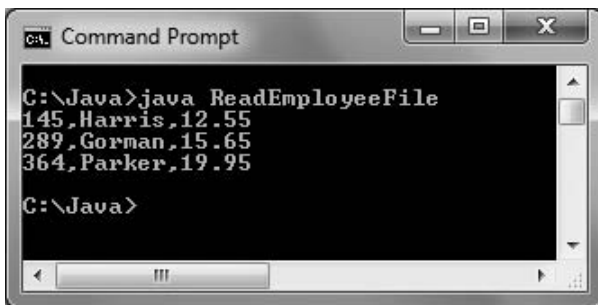
**Figure 13-23** Output file following the program execution in Figure 13-22

Figure 13-24 shows a program that reads the `Employees.txt` file created by the `WriteEmployeeFile` program. The program declares an `InputStream` for the file, then creates a `BufferedReader` using the `InputStream`. The first line is read into a `String`; as long as the `readLine()` method does not return `null`, the `String` is displayed and a new line is read.

Figure 13-25 shows the output of the `ReadEmployeeFile` program when it uses the file that was created during the execution in Figure 13-22. Each comma-separated `String` is displayed on its own line.

```
import java.nio.file.*;
import java.io.*;
public class ReadEmployeeFile
{
    public static void main(String[] args)
    {
        Path file =
            Paths.get("C:\\Java\\Chapter.13\\Employees.txt");
        String s = "";
        try
        {
            InputStream input = new
                BufferedInputStream(file.newInputStream());
            BufferedReader reader = new
                BufferedReader(new InputStreamReader(input));
            s = reader.readLine();
            while(s != null)
            {
                System.out.println(s);
                s = reader.readLine();
            }
            reader.close();
        }
        catch(Exception e)
        {
            System.out.println("Message: " + e);
        }
    }
}
```

Figure 13-24 The ReadEmployeeFile class



```
C:\Java>java ReadEmployeeFile
145,Harris,12.55
289,Gorman,15.65
364,Parker,19.95
C:\Java>
```

Figure 13-25 Output of the ReadEmployeeFile program

Many applications would not want to use the file data only as a `String` like the `ReadEmployeeFile` program does. Figure 13-26 shows a more useful program in which the retrieved file `Strings` are split into usable fields. The `String` class `split()` method accepts an argument that identifies the field delimiter (in this case, a comma) and returns an array of

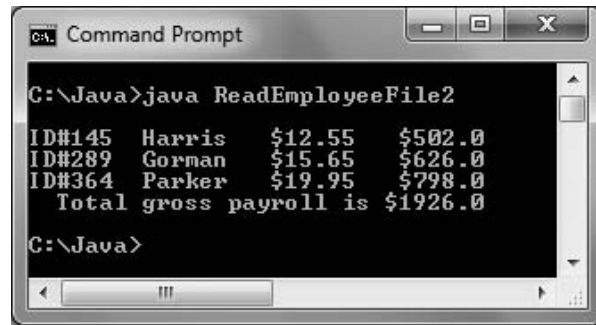
Strings. Each array element holds one field. Then methods such as `parseInt()` and `parseDouble()` can be used to reformat the split Strings into their respective data types.

```
import java.nio.file.*;
import java.io.*;
public class ReadEmployeeFile2
{
    public static void main(String[] args)
    {
        Path file =
            Paths.get("C:\\Java\\Chapter.13\\Employees.txt");
        String[] array = new String[3];
        String s = "";
        String delimiter = ",";
        int id;
        String name;
        double payRate;
        double gross;
        final double HRS_IN_WEEK = 40;
        double total = 0;
        try
        {
            InputStream input = new
                BufferedInputStream(file.newInputStream());
            BufferedReader reader = new
                BufferedReader(new InputStreamReader(input));
            System.out.println();
            s = reader.readLine();
            while(s != null)
            {
                array = s.split(delimiter);
                id = Integer.parseInt(array[0]);
                name = array[1];
                payRate = Double.parseDouble(array[2]);
                gross = payRate * HRS_IN_WEEK;
                System.out.println("ID#" + id + " " + name +
                    " $" + payRate + " $" + gross);
                total += gross;
                s = reader.readLine();
            }
            reader.close();
        }
        catch(Exception e)
        {
            System.out.println("Message: " + e);
        }
        System.out.println(" Total gross payroll is $" + total);
    }
}
```

Figure 13-26 The `ReadEmployeeFile2` class



As each record is read and split in the `ReadEmployeeFile2` class, its pay rate field is used to calculate gross pay for the employee based on a 40-hour work week. Then the gross is accumulated to produce a total gross payroll that is displayed after all the data has been processed. Figure 13-27 shows the program's execution.



```

C:\Java>java ReadEmployeeFile2
ID#145  Harris   $12.55  $502.0
ID#289  Gorman   $15.65  $626.0
ID#364  Parker   $19.95  $798.0
Total gross payroll is $1926.0
C:\Java>

```

**Figure 13-27** Execution of the `ReadEmployeeFile2` program

## TWO TRUTHS & A LIE

### Creating and Using Sequential Data Files

1. A `BufferedWriter` writes text to an output stream, buffering the characters.
2. A data file does not require a newline character after each record, but adding a new line makes the output file easier for a person to read and interpret.
3. The `String` class `split()` method converts parts of a `String` to `ints`, `doubles`, and other data types.

The false statement is #3. The `String` class `split()` method accepts an argument that identifies a field delimiter and returns an array of `Strings` in which each array element holds one field. Then you can use methods such as `parseInt()` and `parseDouble()` to convert the split `Strings` to other data types.

## Learning about Random Access Files

The file examples in the first part of this chapter have been sequential access files, which means that you work with the records in sequential order from beginning to end. For example, in the `ReadEmployeeFile` programs, if you write an employee record with an ID number of 145 and then write a second record with an ID number of 289, the records remain in the original data-entry order when you retrieve them. Businesses store data in sequential order when they use the records for **batch processing**, which involves performing the same tasks with many records, one after the other. For example, when a company produces customer bills, the records for the billing period are gathered in a batch and the bills are calculated and printed in sequence. It doesn't matter whose bill is produced first because none are distributed to customers until all the bills in the group have been printed and mailed.



Besides indicating a system that works with many records, the term *batch processing* can refer to a system in which you issue many operating-system commands as a group.

For many applications, sequential access is inefficient. These applications, known as **real-time** applications, require that a record be accessed immediately while a client is waiting. A program in which the user makes direct requests is an **interactive program**. For example, if a customer telephones a department store with a question about a monthly bill, the customer service representative does not want to access every customer account in sequence. Suppose that the store's database contains thousands of account records to read, and that the customer record in question is near the end of the list. It would take too long to access the customer's record if all the records had to be read sequentially. Instead, customer service representatives require **random access files**—files in which records can be retrieved directly in any order. Random files are also called **direct access files** or **instant access files**.

You can use Java's `FileChannel` class to create your own random access files. A **file channel** object is an avenue for reading and writing a file. A file channel is **seekable**, meaning you can search for a specific file location and operations can start at any specified position. Table 13-7 describes some `FileChannel` methods.

FileChannel method	Description
<code>FileChannel open(Path file, OpenOption... options)</code>	Opens or creates a file, returning a file channel to access the file
<code>long position()</code>	Returns the channel's file position
<code>FileChannel position(long newPosition)</code>	Sets the channel's file position
<code>int read(ByteBuffer buffer)</code>	Reads a sequence of bytes from the channel into the buffer
<code>long size()</code>	Returns the size of the channel's file
<code>int write(ByteBuffer buffer)</code>	Writes a sequence of bytes to the channel from the buffer

**Table 13-7** Selected `FileChannel` methods

Several methods in Table 13-7 use a `ByteBuffer` object. As its name describes, a `ByteBuffer` is simply a holding place for bytes waiting to be read or written. An array of bytes can be **wrapped**, or encompassed, into a `ByteBuffer` using the `ByteBuffer.wrap()` method. Wrapping a byte array into a buffer causes changes to the buffer to change the array as well, and causes changes to the array to change the buffer. Creating a usable `FileChannel` for randomly writing data requires creating a `ByteBuffer` and several other steps:

- You can use the `Path` class `newByteChannel()` method to get a `ByteChannel` for a `Path`. The `newByteChannel()` method accepts `StandardOpenOption` arguments that specify how the file will be opened.

- The `ByteChannel` returned by the `newByteChannel()` method can then be cast to a `FileChannel` using a statement similar to the following:

```
FileChannel fc = (FileChannel)file.newByteChannel(READ, WRITE);
```
- You can create a byte array. For example, a byte array can be built from a `String` using the `getBytes()` method as follows:

```
String s = "XYZ";  
byte[] data = s.getBytes();
```
- The byte array can be wrapped into a `ByteBuffer` as follows:

```
ByteBuffer out = ByteBuffer.wrap(data);
```
- Then the filled `ByteBuffer` can be written to the declared `FileChannel` with a statement such as the following:

```
fc.write(out);
```
- You can test whether a `ByteBuffer`'s contents have been used up by checking the `hasRemaining()` method.
- After you have written the contents of a `ByteBuffer`, you can write the same `ByteBuffer` contents again by using the `rewind()` method to reposition the `ByteBuffer` to the beginning of the buffer.

Figure 13-28 employs all these steps to declare a file and write some bytes in it randomly at positions 0, 22, and 12, in that order.

```
import java.nio.file.*;  
import java.io.*;  
import java.nio.channels.FileChannel;  
import java.nio.ByteBuffer;  
import static java.nio.file.StandardOpenOption.*;  
public class RandomAccessTest  
{  
    public static void main(String[] args)  
    {  
        Path file =  
            Paths.get("C:\\Java\\Chapter.13\\Numbers.txt");  
        String s = "XYZ";  
        byte[] data = s.getBytes();  
        ByteBuffer out = ByteBuffer.wrap(data);  
        FileChannel fc = null;  
        try  
        {  
            fc = (FileChannel)file.newByteChannel(READ, WRITE);  
            fc.position(0);  
            while(out.hasRemaining())  
                fc.write(out);  
            out.rewind();  
            fc.position(22);
```

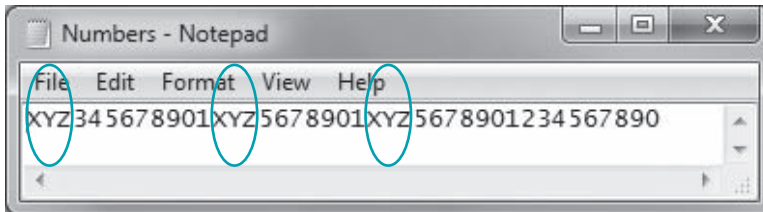
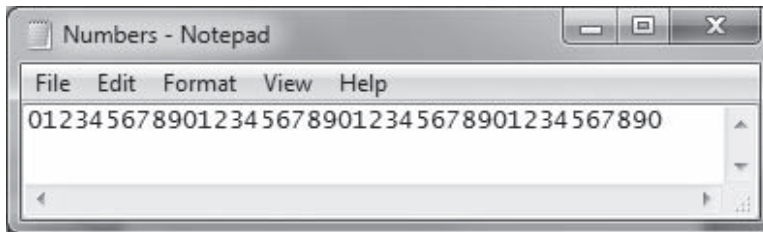
**Figure 13-28** The `RandomAccessTest` class (continues)

(continued)

```
        while(out.hasRemaining())
            fc.write(out);
        out.rewind();
        fc.position(12);
        while(out.hasRemaining())
            fc.write(out);
        fc.close();
    }
    catch (Exception e)
    {
        System.out.println("Error message: " + e);
    }
}
```

**Figure 13-28** The RandomAccessTest class

Figure 13-29 shows the Numbers.txt text file before and after executing the RandomAccessTest program in Figure 13-28. The String "XYZ" has been written at positions 0, 8, and 12.



**Figure 13-29** The Numbers.txt file before and after execution of RandomAccessTest

**TWO TRUTHS & A LIE****Learning about Random Access Files**

1. Businesses store data in random order when they use the records for batch processing.
2. Real-time applications are interactive and require using random access data files.
3. A `FileChannel` object is a seekable channel for reading and writing a file.

The false statement is #1. Businesses store data in sequential order when they use the records for batch processing.

611

**Writing Records to a Random Access Data File**

Writing characters at random text file locations, as in the `RandomAccessTest` program, is of limited value. When you store records in a file, it is often more useful to be able to access the eighth or 12th record rather than the eighth or 12th byte. In such a case, you multiply each record's size by the position you want to access. For example, if you store records that are 50 bytes long, the first record is at position 0, the second record is at position 50, the third record is at position 100, and so on. In other words, you can access the *n*th record in a `FileChannel` named `fc` using the following statement:

```
fc.position((n - 1) * 50);
```

One approach to writing a random access file is to place records into the file based on a key field. A **key field** is the field in a record that makes the record unique from all others. For example, suppose you want to store employee ID numbers, last names, and pay rates in a random access file. In a file of employees, many records might have the same last name or pay rate, but each record has a unique employee ID number, so that field can act as the key field.

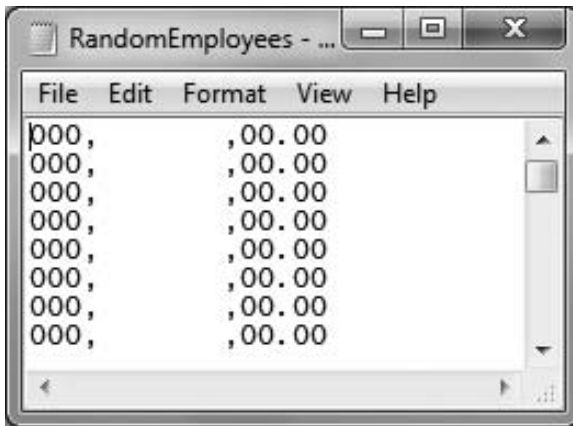
The first step in creating the random access employee file is to create a file that holds default records—for example, using zeroes for the ID numbers and pay rates, and blanks for the names. For this example, assume that each employee ID number is three digits; in other words, you cannot have more than 1,000 employees because the ID number cannot surpass 999. Figure 13-30 contains a program that creates 1,000 such records.

```
import java.nio.file.*;
import java.io.*;
import java.nio.ByteBuffer;
import static java.nio.file.StandardOpenOption.*;
public class CreateEmptyEmployeesFile
{
    public static void main(String[] args)
    {
        Path file =
            Paths.get("C:\\Java\\Chapter.13\\RandomEmployees.txt");
        String s = "000,      ,00.00" +
            System.getProperty("\n.separator");
        byte[] data = s.getBytes();
        ByteBuffer buffer = ByteBuffer.wrap(data);
        FileChannel fc = null;
        final int NUMRECS = 1000;
        try
        {
            OutputStream output = new
                BufferedOutputStream(file.newOutputStream(CREATE));
            BufferedWriter writer = new
                BufferedWriter(new OutputStreamWriter(output));
            for(int count = 0; count < NUMRECS; ++count)
                writer.write(s, 0, s.length());
            writer.close();
        }
        catch(Exception e)
        {
            System.out.println("Error message: " + e);
        }
    }
}
```

**Figure 13-30** The CreateEmptyEmployeesFile class

In the first shaded statement in Figure 13-30, a `String` that represents a default record is declared. The three-digit employee number is set to zeros, the name consists of seven blanks, the pay rate is 00.00, and the `String` ends with the system's line separator value. A byte array is constructed from the `String` and wrapped into a buffer. Then a file is opened in `CREATE` mode and a `BufferedWriter` is established.

In the last shaded statement in Figure 13-30, a loop executes 1,000 times. Within the loop, the default employee string is passed to the `BufferedWriter` object's `write()` method. Figure 13-31 shows a few records from the created file when it is opened in Notepad.



**Figure 13-31** The RandomEmployees.txt file created by the CreateEmptyEmployeesFile program

The default fields in the base random access file don't have to be zeros and blanks. For example, if you wanted 000 to be a legitimate employee ID number or you wanted blanks to represent a correct name, you could use different default values such as 999 or XXXXXXXX. The only requirement is that the default records be recognizable as such.

After you create the base default file, you can replace any of its records with data for an actual employee. You can locate the correct position for the new record by performing arithmetic with the record's key field.

For example, the application in Figure 13-32 creates a single employee record defined in the first shaded statement. The record is for employee 002 with a last name of Newmann and a pay rate of 12.25. In the second shaded statement, the length of this string is assigned to RECSIZE. (In this case, RECSIZE is 19, which includes one character for each character in the sample record string, including the delimiting commas, plus two bytes for the line separator value returned by the `System.getProperty()` method.) After the `FileChannel` is established, the record is written to the file at the position that begins at two times the record size. The value 2 is hard coded in this demonstration program because the employee's ID number is 002.

```
import java.nio.file.*;
import java.io.*;
import java.nio.channels.FileChannel;
import java.nio.ByteBuffer;
import static java.nio.file.StandardOpenOption.*;
public class CreateOneRandomAccessRecord
{
    public static void main(String[] args)
    {
        Path file =
            Paths.get("C:\\Java\\Chapter.13\\RandomEmployees.txt");
```

**Figure 13-32** The CreateOneRandomAccessRecord class (continues)

*(continued)*

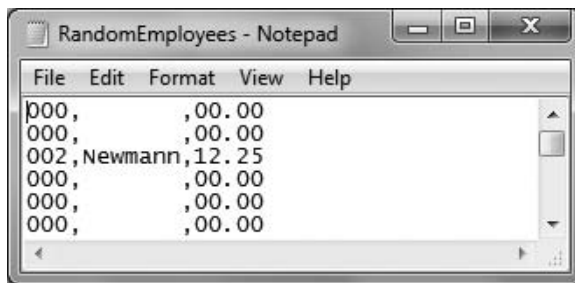
```

String s = "002,Newmann,12.25" +
    System.getProperty("line.separator");
final int RECSIZE = s.length();
byte[] data = s.getBytes();
ByteBuffer buffer = ByteBuffer.wrap(data);
FileChannel fc = null;
try
{
    fc = (FileChannel)file.newByteChannel(READ, WRITE);
    fc.position(2 * RECSIZE);
    fc.write(buffer);
    fc.close();
}
catch (Exception e)
{
    System.out.println("Error message: " + e);
}
}

```

**Figure 13-32** The CreateOneRandomAccessRecord class

Figure 13-33 shows the RandomEmployees.txt file contents after the CreateOneRandomAccessRecord program runs. The employee's data record is correctly placed in the third position in the file. Later, if employees are added that have ID numbers 000 and 001, they can be inserted as the first two records in the file.

**Figure 13-33** The RandomEmployees.txt file after running the CreateOneRandomAccessRecord program

A program that inserts one hard-coded employee record into a data file is not very useful. The program in Figure 13-34 accepts any number of records as user input and writes records to a file in a loop. As shown in the first shaded line in the figure, each employee's data value is accepted from the keyboard as a `String` and converted to an integer using the `parseInt()` method. Then, as shown in the second shaded statement, the record's desired position is computed by multiplying the ID number value by the record size.



```
import java.nio.file.*;
import java.io.*;
import java.nio.channels.FileChannel;
import java.nio.ByteBuffer;
import static java.nio.file.StandardOpenOption.*;
import java.util.Scanner;
public class CreateEmployeesRandomFile
{
    public static void main(String[] args)
    {
        Scanner input = new Scanner(System.in);
        Path file =
            Paths.get("C:\\Java\\Chapter.13\\RandomEmployees.txt");
        String s = "000,          ,00.00" +
            System.getProperty("line.separator");
        final int RECSIZE = s.length();
        FileChannel fc = null;
        String delimiter = ",";
        String idString;
        int id;
        String name;
        String payRate;
        final String QUIT = "999";
        try
        {
            fc = (FileChannel)file.newByteChannel(READ, WRITE);
            System.out.print("Enter employee ID number >> ");
            idString = input.nextLine();
            while(!idString.equals(QUIT))
            {
                id = Integer.parseInt(idString);
                System.out.print("Enter name for employee #" +
                    id + " >> ");
                name = input.nextLine();
                System.out.print("Enter pay rate >> ");
                payRate = input.nextLine();
                s = idString + delimiter + name + delimiter +
                    payRate + System.getProperty("line.separator");
                byte[] data = s.getBytes();
                ByteBuffer buffer = ByteBuffer.wrap(data);
                fc.position(id * RECSIZE);
                fc.write(buffer);
                System.out.print("Enter next ID number or " +
                    QUIT + " to quit >> ");
                idString = input.nextLine();
            }
            fc.close();
        }
    }
}
```

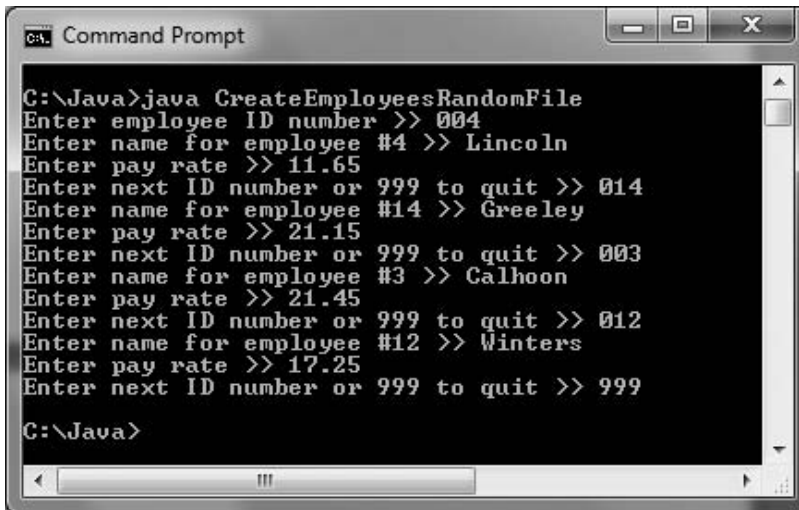
Figure 13-34 The CreateEmployeesRandomFile class (continues)

(continued)

```
        catch (Exception e)
        {
            System.out.println("Error message: " + e);
        }
    }
}
```

**Figure 13-34** The CreateEmployeesRandomFile class

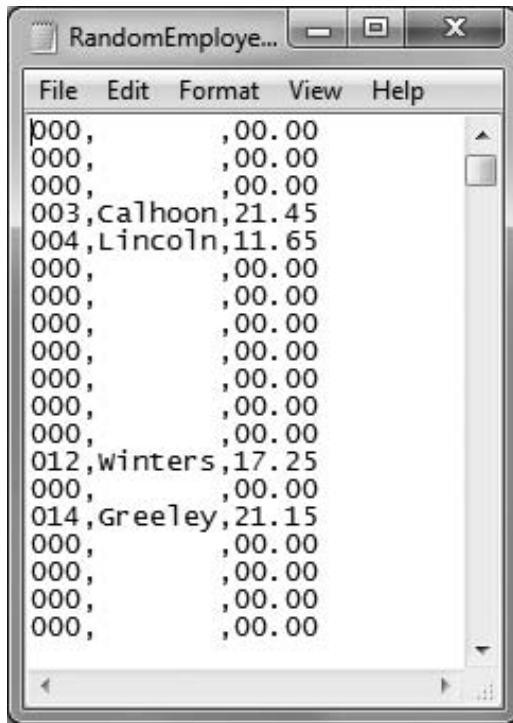
Figure 13-35 shows a typical execution of the program, and Figure 13-36 shows the resulting file. (This program was executed after rerunning the CreateEmptyEmployeesFile program, so all records started with default values, and the record created by the program shown in Figure 13-33 is not part of the file.) In Figure 13-36, you can see that each employee record is not stored based on the order in which it was entered, but is located in the correct spot based on its key field.



```
C:\Java>java CreateEmployeesRandomFile
Enter employee ID number >> 004
Enter name for employee #4 >> Lincoln
Enter pay rate >> 11.65
Enter next ID number or 999 to quit >> 014
Enter name for employee #14 >> Greeley
Enter pay rate >> 21.15
Enter next ID number or 999 to quit >> 003
Enter name for employee #3 >> Calhoon
Enter pay rate >> 21.45
Enter next ID number or 999 to quit >> 012
Enter name for employee #12 >> Winters
Enter pay rate >> 17.25
Enter next ID number or 999 to quit >> 999

C:\Java>
```

**Figure 13-35** Typical execution of the CreateEmployeesRandomFile program



**Figure 13-36** File created during the execution in Figure 13-35

To keep this example brief and focused on the random access file writing, the `CreateEmployeesFile` application makes several assumptions:

- An employee record contains only an ID number, name, and pay rate. In a real application, each employee would require many more data fields, such as address, phone number, date of hire, and so on.
- Each employee ID number is three digits. In many real applications, ID numbers would be longer to ensure unique values. (Three-digit numbers provide only 1,000 unique combinations.)
- The user will enter valid ID numbers and pay rates. In a real application, this would be a foolhardy assumption because users might type too many digits or nonnumeric characters. However, to streamline the code and concentrate on the writing of a random access file, error checking for valid ID numbers and pay rates is eliminated from this example.
- The user will not duplicate employee ID numbers. In a real application, a key field should be checked against all existing key fields to ensure that a record is unique before adding it to a file.
- The names entered are all seven characters. This permits each record to be the same size. Only when record sizes are uniform can they be used to arithmetically calculate offset positions. In a real application, you would have to pad shorter names with spaces and truncate longer names to achieve a uniform size.

- Each employee's record is placed in the random access file position that is one less than the employee's ID number. In many real applications, the mathematical computations performed on a key field to determine file placement are more complicated.

618

## TWO TRUTHS & A LIE

### Writing Records to a Random Access Data File

1. You can set a `FileChannel`'s reading position based on a key field in a record and the record size.
2. A key field is the field in a record that holds the most sensitive information.
3. A useful technique for creating random access files involves first setting up a file with default records in each position.

The false statement is #2. A key field is the field in a record that makes the record unique from all others.

## Reading Records from a Random Access Data File

Just because a file is created as a random access file does not mean it has to be used as one. You can process a random access file either sequentially or randomly.

### Accessing a Random Access File Sequentially

The `RandomEmployees.txt` file created in the previous section contains 1,000 records. However, only four of them contain valuable data. Displaying every record in the file would result in many irrelevant lines of output. It makes more sense to display only the records for which an ID number has been inserted. The application in Figure 13-37 reads through the 1,000-record file sequentially in a `while` loop. This example assumes that no employee has a valid ID number of 000, so the program displays a record only when the ID is not 000. If 000 could be a valid ID number, then you would want to check for a name that was blank, a pay rate that was 0, or both. Figure 13-38 shows the application's output—a list of the entered records, conveniently in ID number order, which reflects their relative positions within the file.

```
import java.nio.file.*;
import java.io.*;
import static java.nio.file.AccessMode.*;
public class ReadEmployeesSequentially
{
    public static void main(String[] args)
```

**Figure 13-37** The `ReadEmployeesSequentially` class (continues)

(continued)

```
{
    Path file =
        Paths.get("C:\\Java\\Chapter.13\\RandomEmployees.txt");
    String[] array = new String[3];
    String s = "";
    String delimiter = ",";
    int id;
    String stringId;
    String name;
    double payRate;
    double gross;
    final double HRS_IN_WEEK = 40;
    double total = 0;
    try
    {
        InputStream input = new
            BufferedInputStream(file.newInputStream());
        BufferedReader reader = new
            BufferedReader(new InputStreamReader(input));
        System.out.println();
        s = reader.readLine();
        while(s != null)
        {
            array = s.split(delimiter);
            stringId = array[0];
            id = Integer.parseInt(array[0]);
            if(id != 0)
            {
                name = array[1];
                payRate = Double.parseDouble(array[2]);
                gross = payRate * HRS_IN_WEEK;
                System.out.println("ID#" + stringId + " " +
                    name + " $" + payRate + " $" + gross);
                total += gross;
            }
            s = reader.readLine();
        }
        reader.close();
    }
    catch(Exception e)
    {
        System.out.println("Message: " + e);
    }
    System.out.println(" Total gross payroll is $" + total);
}
}
```

Figure 13-37 The ReadEmployeesSequentially class



```
C:\Java>java ReadEmployeesSequentially
ID#003  Calhoon   $21.45  $858.0
ID#004  Lincoln    $11.65  $466.0
ID#012  Winters    $17.25  $690.0
ID#014  Greeley    $21.15  $846.0
      Total gross payroll is $2860.0

C:\Java>
```

**Figure 13-38** Output of the `ReadEmployeesSequentially` application

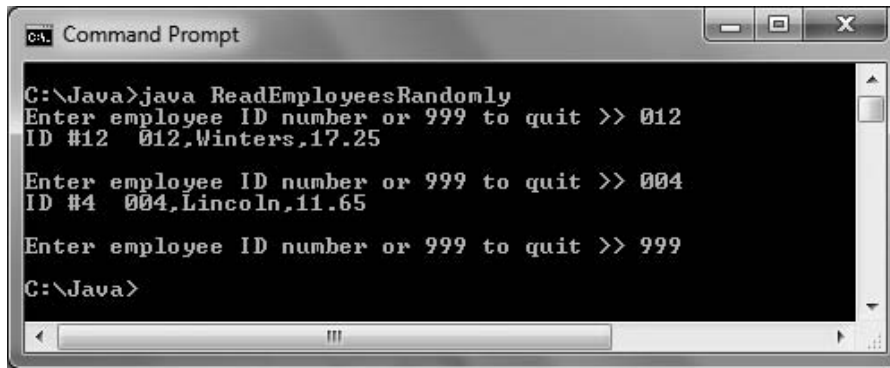
## Accessing a Random Access File Randomly

If you simply want to display records in order based on their key field, you do not need to create a random access file and waste unneeded storage. Instead, you could sort the records using one of the techniques you learned in Chapter 9. The benefit of using a random access file is the ability to retrieve a specific record from a file directly, without reading through other records to locate the desired one.

The `ReadEmployeesRandomly` application in Figure 13-39 allows the user to enter an employee's ID number. The application calculates the correct record position in the data file (one less than the ID number) and positions the file pointer at the correct location to begin reading. The user is then prompted for an ID number, which is converted to an integer with the `parseInt()` method. (To keep this example brief, the application does not check for a valid ID number, so the `parseInt()` method might throw an exception to the operating system, ending the execution of the application.) In the shaded portion of the application in Figure 13-39, while the user does not enter 999 to quit, the position of the sought-after record is calculated by multiplying the ID number by the record size, and then positioning the file pointer at the desired location. (Again, to keep the example short, the ID number is not checked to ensure that it is 999 or less.) The employee record is retrieved from the data file and displayed, and then the user is prompted for the next desired ID number. Figure 13-40 shows a typical execution.

```
import java.nio.file.*;
import java.io.*;
import java.nio.channels.FileChannel;
import java.nio.ByteBuffer;
import static java.nio.file.StandardOpenOption.*;
import java.util.Scanner;
public class ReadEmployeesRandomly
{
    public static void main(String[] args)
    {
        Scanner keyBoard = new Scanner(System.in);
        Path file =
            Paths.get("C:\\Java\\Chapter.13\\RandomEmployees.txt");
        String s = "000,          ,00.00" +
            System.getProperty("line.separator");
        final int RECSIZE = s.length();
        byte[] data = s.getBytes();
        ByteBuffer buffer = ByteBuffer.wrap(data);
        FileChannel fc = null;
        String idString;
        int id;
        final String QUIT = "999";
        try
        {
            fc = (FileChannel)file.newByteChannel(READ, WRITE);
            System.out.print("Enter employee ID number or " +
                QUIT + " to quit >> ");
            idString = keyBoard.nextLine();
            while(!idString.equals(QUIT))
            {
                id = Integer.parseInt(idString);
                buffer = ByteBuffer.wrap(data);
                fc.position(id * RECSIZE);
                fc.read(buffer);
                s = new String(data);
                System.out.println("ID #" + id + " " + s);
                System.out.print("Enter employee ID number or " +
                    QUIT + " to quit >> ");
                idString = keyBoard.nextLine();
            }
            fc.close();
        }
        catch (Exception e)
        {
            System.out.println("Error message: " + e);
        }
    }
}
```

Figure 13-39 The ReadEmployeesRandomly class



```
ca. Command Prompt
C:\Java>java ReadEmployeesRandomly
Enter employee ID number or 999 to quit >> 012
ID #12  012,Winters,17.25

Enter employee ID number or 999 to quit >> 004
ID #4   004,Lincoln,11.65

Enter employee ID number or 999 to quit >> 999
C:\Java>
```

**Figure 13-40** Typical execution of the `ReadEmployeesRandomly` program



Watch the video *Random Access Data Files*.

## TWO TRUTHS & A LIE

### Reading Records from a Random Access Data File

1. When a file is created as a random access file, you also must read it randomly.
2. The benefit of using a random access file is the ability to retrieve a specific record from a file directly, without reading through other records to locate the desired one.
3. When you access a record from a random access file, you usually calculate its position based on a key.

The false statement is #1. Just because a file is created as a random access file does not mean it has to be used as one. You can process the file sequentially or randomly.

## You Do It

### Creating Multiple Random Access Files

In this section, you will write a class that prompts the user for customer data and assigns the data to one of two files depending on the customer's state of residence. This program assumes that Wisconsin (WI) records are assigned to an in-state file and that all other records are assigned to an out-of-state file. First you will create empty files to store the records, and then you will write the code that places each record in the correct file.



## To start the program by creating empty records:

1. Open a new file in your text editor, and type the following required import statements:

```
import java.nio.file.*;
import java.io.*;
import java.nio.channels.FileChannel;
import java.nio.ByteBuffer;
import static java.nio.file.StandardOpenOption.*;
import java.util.Scanner;
import java.text.*;
```

2. Enter the beginning lines of the program, which include a Scanner class object to accept user input:

```
public class CreateFilesBasedOnState
{
    public static void main(String[] args)
    {
        Scanner input = new Scanner(System.in);
```

3. This program uses two Path objects to hold records for in-state and out-of-state customers. You can use a different String value for your Paths based on your System and the location where you want to save your files.

```
Path inStateFile =
    Paths.get("C:\\Java\\Chapter.13\\InStateCusts.txt");
Path outOfStateFile =
    Paths.get("C:\\Java\\Chapter.13\\OutOfStateCusts.txt");
```

4. Build a String that can be used to format the empty files that are created before any actual customer data is written. Include constants for the format of the account number (three digits), the customer name (10 spaces), the customer's state, and the customer's balance (up to 9999.99). After defining the field delimiter (a comma), you can build a generic customer string by assembling the pieces. The record size is then calculated from the dummy record. A consistent record size is important so it can be used to calculate a record's position when the files are accessed randomly.

```
final String ID_FORMAT = "000";
final String NAME_FORMAT = "          ";
final int NAME_LENGTH = NAME_FORMAT.length();
final String HOME_STATE = "WI";
final String BALANCE_FORMAT = "0000.00";
String delimiter = ",";
String s = ID_FORMAT + delimiter + NAME_FORMAT +
    delimiter + HOME_STATE + delimiter + BALANCE_FORMAT +
    System.getProperty("line.separator");
final int RECSIZE = s.length();
```

5. The last declarations are for two FileChannel references; String and integer representations of the customer's account number; the customer's name, state, and balance fields; and a QUIT constant that identifies the end of data entry.

```

FileChannel fcIn = null;
FileChannel fcOut = null;
String idString;
int id;
String name;
String state;
double balance;
final String QUIT = "999";

```

- Next, call a method that creates the empty files into which the randomly placed data records can eventually be written. The method accepts the Path for a file and the String that defines the record format.

```

createEmptyFile(inStateFile, s);
createEmptyFile(outOfStateFile, s);

```

- Add closing curly braces for the main() method and the class. Then save the file as **CreateFilesBasedOnState.java** and compile it. Correct any errors before proceeding.

## Writing a Method to Create an Empty File

In this section, you will write the method that creates empty files using the default record format string. The method will create 1,000 records with an account number of 000.

### To write the method that creates empty records:

- Just before the closing curly brace of the CreateFilesBasedOnState class, insert the header and opening brace for a method that will create an empty file to hold random access records. The method accepts a Path argument and the default record String.

```

public static void createEmptyFile(Path file, String s)
{

```

- Define a constant for the number of records to be written:

```

final int NUMRECS = 1000;

```

- In a try block, declare a new OutputStream using the method's Path parameter. Then create a BufferedWriter using the OutputStream.

```

try
{
    OutputStream outputStr = new
        BufferedOutputStream(file.newOutputStream(CREATE));
    BufferedWriter writer = new BufferedWriter(new
        OutputStreamWriter(outputStr));

```

- Use a for loop to write 1,000 default records using the parameter String. Then close the BufferedWriter, and add a closing brace for the try block.

```

for(int count = 0; count < NUMRECS; ++count)
    writer.write(s, 0, s.length());
    writer.close();
}

```

5. Add a catch block to handle any Exception thrown from the try block, and add a closing curly brace for the method.

```

catch(Exception e)
{
    System.out.println("Error message: " + e);
}
}

```

625

6. Save the file and compile it. Correct any errors.

## Adding Data Entry Capability to the Program

In the next section, you will add the code that accepts data from the keyboard and writes it to the correct location (based on the customer's account number) within the correct file (based on the customer's state).

### To add the data entry code to the program:

1. After the calls to the `createEmptyFile()` method, but before the method header, start a try block that will handle all the data entry and file writing for customer records:

```

try
{

```

2. Set up the `FileChannel` references for both the in-state and out-of-state files.

```

fcIn = (FileChannel)inStateFile.newByteChannel
(CREATE, WRITE);
fcOut = (FileChannel)outOfStateFile.newByteChannel
(CREATE, WRITE);

```

3. Prompt the user for a customer account number and accept it from the keyboard. Then start a loop that will continue as long as the user does not enter the QUIT value. Next, convert the entered account number to an integer so it can be used to calculate the file position for the entered record. In a full-blown application, you would add code to ensure that the account number is three digits, but to keep this example shorter, this program assumes that the user will enter valid account numbers.

```

System.out.print("Enter customer account number >> ");
idString = input.nextLine();
while(!(idString.equals(QUIT)))
{
    id = Integer.parseInt(idString);

```

4. Prompt the user for and accept the customer's name. To ensure that entered names are stored using a uniform length, assign the name to a `StringBuilder` object, and set the length to the standard length. Then assign the newly sized `StringBuilder` back to the `String`.

```

System.out.print("Enter name for customer >> ");
name = input.nextLine();
StringBuilder sb = new StringBuilder(name);
sb.setLength(NAME_LENGTH);
name = sb.toString();

```

5. Prompt the user for and accept the customer's state of residence. (In a fully developed program, you would check the entered state against a list of valid states, but this step is omitted to keep the program shorter.)

```
System.out.print("Enter state >> ");  
state = input.nextLine();
```

6. Prompt the user for and accept the customer's balance. Because you use the `nextDouble()` method to retrieve the balance, you follow it with a call to `nextLine()` to absorb the Enter key value left in the input stream. Then you can use the `DecimalFormat` class to ensure that the balance meets the format requirements of the file. Because the `BALANCE_FORMAT` String's value is `0000.00`, zeros will be added to the front or back of any `double` that would not otherwise meet the standard. For example, `200.99` will be stored as `0200.99`, and `0.1` will be stored as `0001.00`. Appendix C contains more information on the `DecimalFormat` class and describes other potential formats.

```
System.out.print("Enter balance >> ");  
balance = input.nextDouble();  
input.nextLine();  
DecimalFormat df = new DecimalFormat(BALANCE_FORMAT);
```

7. Construct the `String` to be written to the file by concatenating the entered fields with the comma delimiter and the line separator.

```
s = idString + delimiter + name + delimiter +  
state + delimiter + df.format(balance) +  
System.getProperty("line.separator");
```

8. Convert the constructed `String` to an array of bytes and wrap the array into a `ByteBuffer`.

```
byte data[] = s.getBytes();  
ByteBuffer buffer = ByteBuffer.wrap(data);
```

9. Depending on the customer's state, use the in-state or out-of-state `FileChannel`. Position the file pointer to start writing a record in the correct position based on the account number, and write the data `String`.

```
if(state.equals(HOME_STATE))  
{  
    fcIn.position(id * RECSIZE);  
    fcIn.write(buffer);  
}  
else  
{  
    fcOut.position(id * RECSIZE);  
    fcOut.write(buffer);  
}
```

10. Prompt the user for the next customer account number and add a closing curly brace for the `while` loop.

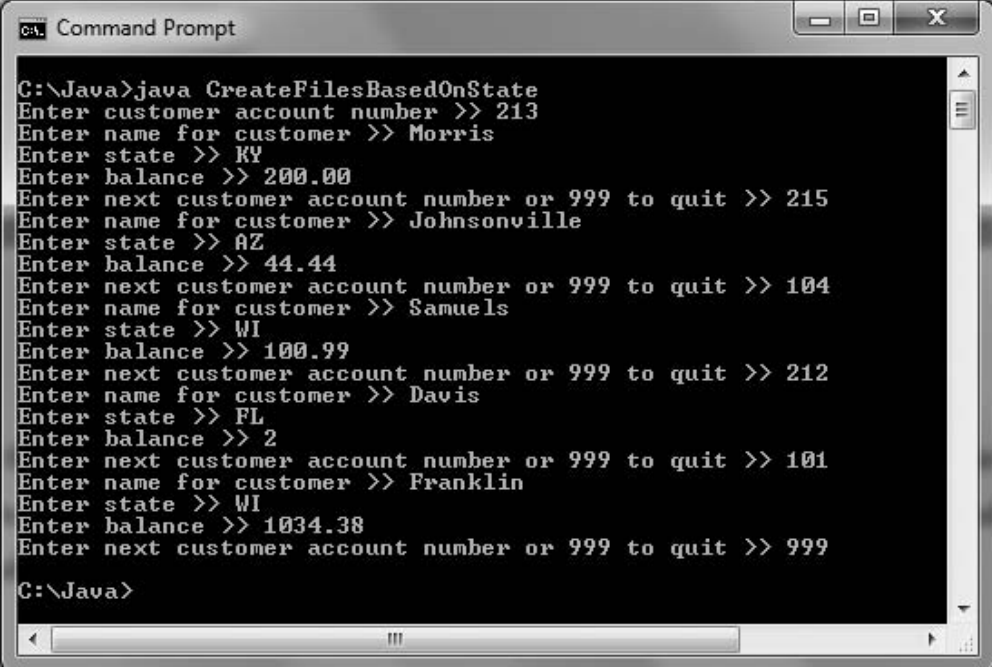
```
    System.out.print("Enter next customer account number or " +  
        QUIT + " to quit >> ");  
    idString = input.nextLine();  
}
```

11. Close the `FileChannels` and add a closing curly brace for the class.

```
        fcIn.close();
        fcOut.close();
    }
```

12. Save the file and compile it. Execute the program, and enter several records. Make sure to include names that are longer and shorter than 10 characters, and to include a variety of balance values. Figure 13-41 shows a typical execution.

627

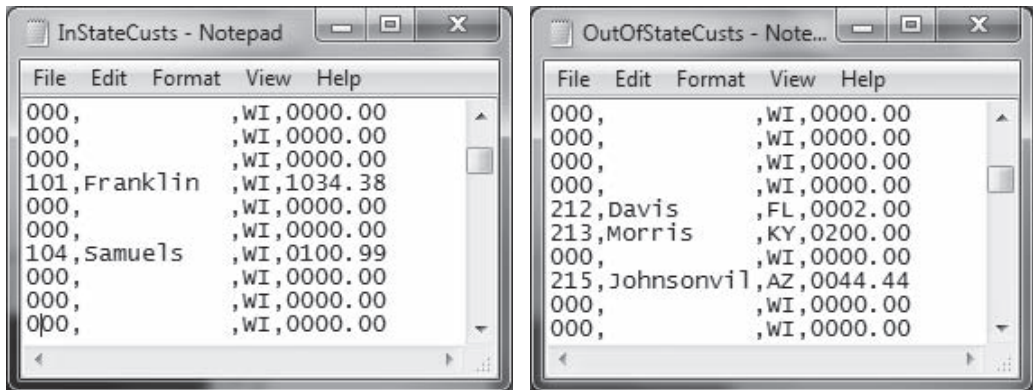


```
C:\Java>java CreateFilesBasedOnState
Enter customer account number >> 213
Enter name for customer >> Morris
Enter state >> KY
Enter balance >> 200.00
Enter next customer account number or 999 to quit >> 215
Enter name for customer >> Johnsonville
Enter state >> AZ
Enter balance >> 44.44
Enter next customer account number or 999 to quit >> 104
Enter name for customer >> Samuels
Enter state >> WI
Enter balance >> 100.99
Enter next customer account number or 999 to quit >> 212
Enter name for customer >> Davis
Enter state >> FL
Enter balance >> 2
Enter next customer account number or 999 to quit >> 101
Enter name for customer >> Franklin
Enter state >> WI
Enter balance >> 1034.38
Enter next customer account number or 999 to quit >> 999

C:\Java>
```

**Figure 13-41** Typical execution of the `CreateFilesBasedOnState` program

13. Locate and open the `InStateCusts.txt` and `OutOfStateCusts.txt` files. Scroll through the files until you find the records you created. Figure 13-42 shows part of both files that contain the records added using the execution in Figure 13-41. Confirm that each record is placed in the correct file location, that each name and balance is in the correct format, and that the records with a state value of “WI” are placed in one file while all the other records are placed in the other file.



**Figure 13-42** Contents of the files created by the program execution in Figure 13-41

## Setting Up a Program to Read the Created Files

In the next section, you will write a program that can use either of the files you just created. The program has four parts:

- The program will prompt the user to enter the filename to be used and set up all necessary variables and constants.
- A few statistics about the file will be displayed.
- The nondefault contents of the file will be displayed sequentially.
- A selected record from the file will be accessed directly.

### To start the program that will work with a filename entered by a user:

1. Open a new file in your text editor. Enter all the required import statements and the class header for the `ReadStateFile` application.

```
import java.nio.file.*;
import java.io.*;
import java.nio.file.attribute.*;
import static java.nio.file.StandardOpenOption.*;
import java.nio.ByteBuffer;
import java.nio.channels.FileChannel;
import java.util.Scanner;
public class ReadStateFile
{
```

2. Declare a `Scanner` object to handle keyboard input. Then declare a `String` that will hold the name of the file the program will use. Prompt the user for the filename, concatenate it with the correct path, and create a `Path` object.

```
Scanner kb = new Scanner(System.in);
String fileName;
System.out.print("Enter name of file to use >> ");
fileName = kb.nextLine();
fileName = "C:\\Java\\Chapter.13\\" + fileName;
Path file = Paths.get(fileName);
```

3. Add the String formatting constants and build a sample record String so that you can determine the record size. To save time, you can copy these declarations from the CreateFilesBasedOnState program.

```
final String ID_FORMAT = "000";
final String NAME_FORMAT = "      ";
final int NAME_LENGTH = NAME_FORMAT.length();
final String HOME_STATE = "WI";
final String BALANCE_FORMAT = "0000.00";
String delimiter = ",";
String s = ID_FORMAT + delimiter + NAME_FORMAT + delimiter +
    HOME_STATE + delimiter + BALANCE_FORMAT +
    System.getProperty("line.separator");
final int RECSIZE = s.length();
```

4. The last set of declarations includes a byte array that you will use with a ByteBuffer later in the program, a String that represents the account number in an empty account, and an array of strings that can hold the pieces of a split record after it is read from the input file. Add a variable for the numeric customer balance, which will be converted from the String stored in the file. Also, declare a total and initialize it to 0 so the total customer balance due value can be accumulated.

```
byte data[] = s.getBytes();
final String EMPTY_ACCT = "000";
String[] array = new String[4];
double balance;
double total = 0;
```

5. Add a closing curly brace for the method and the class. Save the file as **ReadStateFile.java**. Compile the file and correct any errors.

## Displaying File Statistics

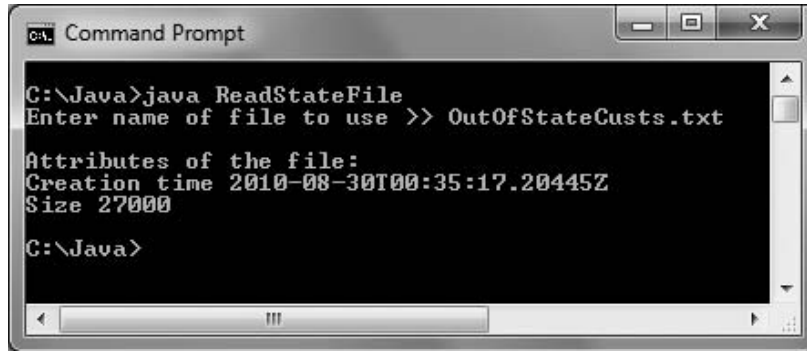
In the next section of the program, you will display the creation time and size of the file.

### To display the file's creation time and size:

1. Just before the two closing curly braces you just added to the program, insert a try block in which you declare a `BasicFileAttributes` object. Then add statements to display the file's creation time and size. Include a catch block to handle any thrown exceptions.

```
try
{
    BasicFileAttributes attr =
        Attributes.readBasicFileAttributes(file);
    System.out.println("\nAttributes of the file:");
    System.out.println("Creation time " + attr.creationTime());
    System.out.println("Size " + attr.size());
}
catch (IOException e)
{
    System.out.println("IO Exception");
}
```

2. Save the file, then compile and execute it. When prompted, you can type the name of either the **InStateCusts.txt** file or the **OutOfStateCusts.txt** file. Figure 13-43 shows a typical execution at this point; you will continue working on this program in the next two You Do It exercises.



**Figure 13-43** Typical execution of ReadStateFile program

## Reading a File Sequentially

In the next section of the program, you will display all the entered records in the file of the user's choice.

### To display the file's entered records sequentially:

1. Start a new try...catch pair after the first one ends, but before the two closing curly braces in the program. Declare an `InputStream` and `BufferedReader` to handle reading the file.

```
try
{
    InputStream iStream = new
        BufferedInputStream(file.newInputStream());
    BufferedReader reader = new
        BufferedReader(new InputStreamReader(iStream));
```

2. Display a heading, then read the first record from the file into a `String`.

```
System.out.println("\nAll non-default records:\n");
s = reader.readLine();
```

3. In a loop that continues while more data is read, split the `String` using the comma delimiter. Test the first split element, the account number, and proceed only if it is not "000". If the record was entered in the previous program, display the split `String` elements. Add the balance to a running total. As the last action in the loop, read the next record.

```
while(s != null)
{
    array = s.split(delimiter);
    if(!array[0].equals(EMPTY_ACCT))
```



```
    {  
        balance = Double.parseDouble(array[3]);  
        System.out.println("ID #" + array[0] + " " +  
            array[1] + array[2] + " $" + array[3]);  
        total += balance;  
    }  
    s = reader.readLine();  
}
```

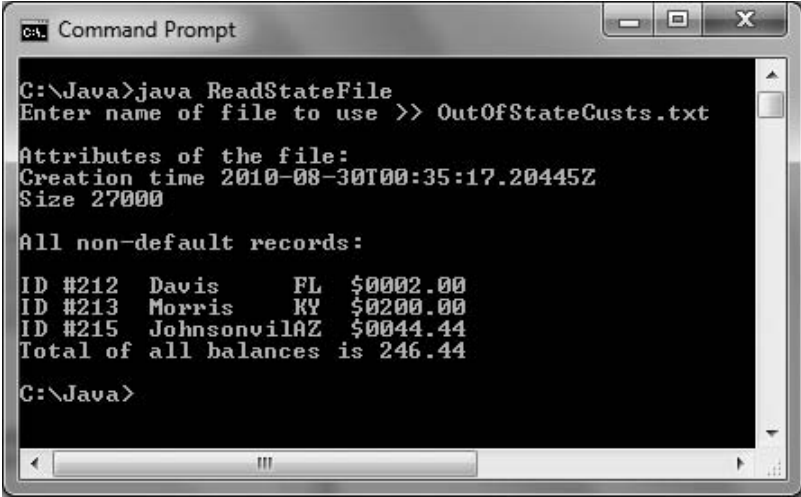
4. After all the records have been processed, display the total and close the reader. Add a closing curly brace for the try block.

```
    System.out.println("Total of all balances is $" + total);  
    reader.close();  
}
```

5. Create a catch block to handle any thrown exceptions.

```
catch(Exception e)  
{  
    System.out.println("Message: " + e);  
}
```

6. Save the file, then compile and execute it. Enter the name of either data file. Figure 13-44 shows a typical execution. After the file statistics are displayed, the records you added earlier are also displayed, and the balances are accumulated.



```
Command Prompt  
C:\Java>java ReadStateFile  
Enter name of file to use >> OutOfStateCusts.txt  
  
Attributes of the file:  
Creation time 2010-08-30T00:35:17.20445Z  
Size 27000  
  
All non-default records:  
ID #212  Davis    FL  $0002.00  
ID #213  Morris   KY  $0200.00  
ID #215  JohnsonvilAZ $0044.44  
Total of all balances is 246.44  
  
C:\Java>
```

**Figure 13-44** Typical execution of `ReadStateFile` program after code has been added to display records

## Reading a File Randomly

In the last part of the program, you will ask the user to enter an account number and then display the record directly by repositioning the file pointer.

### To display a random record:

1. After the closing brace of the last catch block, but before the two final closing braces in the class, add a new try block that declares a `FileChannel` and `ByteBuffer`, then prompts the user for and accepts an account to search for in the file.

```
try
{
    FileChannel fc =
        (FileChannel)file.newByteChannel(READ);
    ByteBuffer buffer = ByteBuffer.wrap(data);
    int findAcct;
    System.out.print("\nEnter account to seek >> ");
    findAcct = kb.nextInt();
```

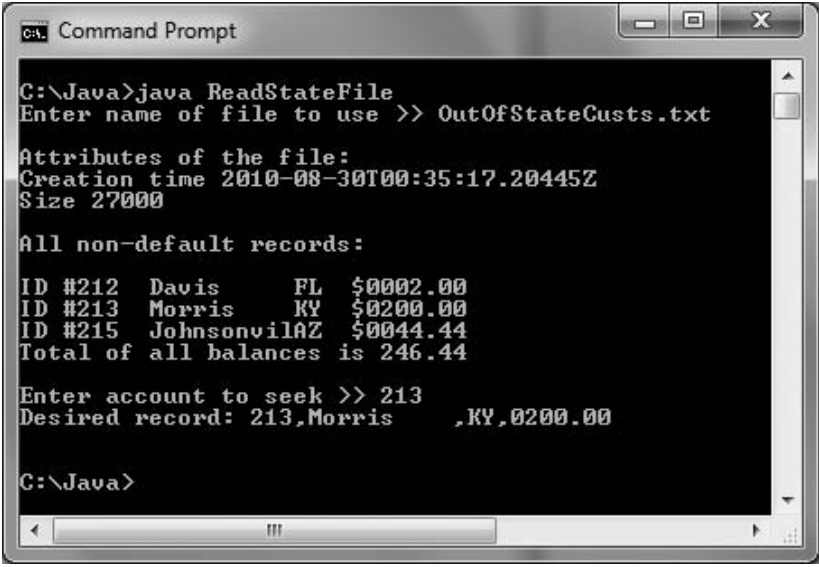
2. Calculate the position of the sought record in the file by multiplying the record number by the file size. Read the selected record into the `ByteBuffer`, and convert the associated byte array to a `String` that you can display. Add a closing curly brace for the try block.

```
        fc.position(findAcct * RECSIZE);
        fc.read(buffer);
        s = new String(data);
        System.out.println("Desired record: " + s);
    }
```

3. Add a catch block to handle any exceptions.

```
catch(Exception e)
{
    System.out.println("Message: " + e);
}
```

4. Save the file, then compile and execute it. Figure 13-45 shows a typical execution. First, the file attributes are displayed, then all the records are displayed, and then a record selected by the user is displayed.



```
C:\Java>java ReadStateFile
Enter name of file to use >> OutOfStateCusts.txt

Attributes of the file:
Creation time 2010-08-30T00:35:17.20445Z
Size 27000

All non-default records:
ID #212  Davis      FL  $0002.00
ID #213  Morris      KY  $0200.00
ID #215  JohnsonvilAZ $0044.44
Total of all balances is 246.44

Enter account to seek >> 213
Desired record: 213, Morris      , KY ,0200.00

C:\Java>
```

**Figure 13-45** Typical execution of `ReadStateFile` program after code has been completed

## Don't Do It

- Don't forget that a `Path` name might be relative and that you might need to make the `Path` absolute before accessing it.
- Don't forget that the backslash character starts the escape sequence in Java, so you must use two backslashes in a string that describes a `Path` in the DOS operating system.

## Key Terms

**Volatile storage** is temporary storage that is lost when a computer loses power.

**Random access memory (RAM)** is the temporary storage within a computer.

**Nonvolatile storage** is permanent storage; it is not lost when a computer loses power.

A **computer file** is a collection of data stored on a nonvolatile device in a computer system.

**Permanent storage devices**, such as hard disks, Zip disks, USB drives, reels or cassettes of magnetic tape, and compact discs, are nonvolatile and hold files.

**Text files** contain data that can be read in a text editor because the data has been encoded using a scheme such as ASCII or Unicode.

**Data files** contain facts and figures, such as a payroll file that contains employee numbers, names, and salaries.

**Program files** or **application files** store software instructions.

**Binary files** contain data that has not been encoded as text; their contents are in binary format.

The **root directory** of a storage device is the main directory.

**Folders** or **directories** are used to organize stored files.

A **path** is the complete list of the disk drive plus the hierarchy of directories in which a file resides.

A **path delimiter** is the character used to separate path components.

The **Path class** is a Java class used to work with file information, such as its location, size, creation date, and whether the file exists.

**Factory methods** are methods that assist in object creation.

An **absolute path** is a complete path; it does not need any other information to locate a file on a system.

A **relative path** is one that depends on other path information.

Java's **static import feature** allows you to use `static` constants without their class name.

A **TOCTTOU bug** is an error that occurs when changes take place from Time Of Check To Time Of Use.

A **character** can be any letter, number, or special symbol (such as a punctuation mark) that comprises data.

A **field** is a group of characters that has some meaning.

A **record** is a collection of fields that contain data about an entity.

In a **sequential access file**, each record is accessed one after another in the order in which it was stored.

**Comma-separated values (CSV)** are fields that are separated with a comma.

To **open a file** is to create an object and associate a stream of bytes with it.

To **close the file** is to make it no longer available to an application.

A **stream** is a data pipeline or channel.

A **buffer** is a memory location where bytes are held after they are logically output, but before they are sent to the output device.

**Flushing** clears any bytes that have been sent to a buffer for output, but that have not yet been output to a hardware device.

**Batch processing** involves performing the same tasks with many records, one after the other.

**Real-time** applications require that a record be accessed immediately while a client is waiting.

In an **interactive program**, a user makes direct requests to a system.

**Random access files** are files in which records can be retrieved directly in any order.

**Direct access files** and **instant access files** are alternate names for *random access files*.

A **file channel** object is an avenue for reading and writing a file.

**Seekable** describes a file channel in which you can search for a specific file location and in which operations can start at any specified position.

To be **wrapped** is to be encompassed in another type.

A **key field** is the field in a record that makes the record unique from all others.

## Chapter Summary

- Data items can be stored on two broad types of storage devices in a computer system—temporary, volatile storage, or permanent, nonvolatile storage. A computer file is a collection of data stored on a nonvolatile device. Files can be text files or binary files, but they all have many common characteristics—each file has a size that specifies the space it occupies on a section of disk or other storage device, and each file has a name and a specific time of creation.
- You can use Java's `Path` class to gather file information, such as its location, size, creation date, and whether the file even exists. To create a `Path`, you determine the default file system on the host computer and then use the `getPath()` method with it. An absolute path is a complete path; a relative path depends on other path information. The `Path` class contains useful methods such as `toString()`, `getName()`, `getNameCount()`, and `getName(int)`.
- Businesses organize data in a hierarchy of character, field, record, and file. In a sequential access file, each stored record is accessed one after another based on the value in a field. When records are not used in sequence, the file is used as a random access file. When you perform input and output operations, bytes flow into a program stream, which functions as a pipeline or channel. A buffer is a memory location where bytes are held after they are logically output, but before they are sent to an output device. Using a buffer to accumulate input or output before issuing the IO command improves program performance. Flushing clears any bytes that have been sent to a buffer for output, but have not yet been output to a hardware device.
- `InputStream`, `OutputStream`, and `Reader` are subclasses of the `Object` class that are used for input and output. Output devices can be assigned to `OutputStream` references, allowing your applications to save data to them. You can create a file and write to it by using the `Path` class `newOutputStream()` method. To open a file for reading, you can use the `newInputStream()` method.
- You can store data files with the help of the `BufferedWriter` class, which contains three overloaded `write()` methods. Files can then be read using the `BufferedReader` class. The `String` class `split()` method accepts an argument that identifies a field delimiter and returns an array of `Strings` in which each array element holds one field.

- Businesses store data in sequential order when they use the records for batch processing, which involves performing the same tasks with many records, one after the other. Real-time applications require interactive processing with random access files. You can use Java's `FileChannel` class to create your own random access files. A file channel object is an avenue for reading and writing a file. A file channel is seekable, meaning you can search for a specific file location, and operations can start at any specified position.
- One approach to writing a random access file is to place records into the file based on a key field that makes a record unique from all others. The first step in creating the random access file is to create a file that holds default records. Then you can replace any default record with actual data by setting the file channel position.
- You can process a random access file either sequentially or randomly. The benefit of using a random access file is the ability to retrieve a specific record from a file directly, without reading through other records to locate the desired one.

## Review Questions

1. Which of the following statements is true?
  - a. Volatile storage lasts only a few seconds.
  - b. Volatile storage is lost when a computer loses power.
  - c. Computer disks are volatile storage devices.
  - d. All of the above are true.
2. A collection of data stored on a nonvolatile device in a computer system is \_\_\_\_\_.
  - a. a file
  - b. an application
  - c. volatile
  - d. a type of binary file
3. A complete list of the disk drive plus the hierarchy of directories in which a file resides is its \_\_\_\_\_.
  - a. directory
  - b. folder
  - c. delimiter
  - d. path
4. Which of the following statements creates a `Path` named `p` to a `File` named `f`?
  - a. `Path p = new Path("C:\\Java\\MyFile.txt");`
  - b. `Path p = f("C:\\Java\\MyFile.txt");`
  - c. `Path p = f.getPath("C:\\Java\\MyFile.txt");`
  - d. `Path p = getPath(new f("C:\\Java\\MyFile.txt"));`
5. A path that needs no other information to locate it is \_\_\_\_\_.
  - a. an absolute path
  - b. a relative path
  - c. a final path
  - d. a constant path

6. The `Path` class `getName()` method returns \_\_\_\_\_.
  - a. the `String` representation of a `Path`
  - b. an absolute `Path`
  - c. the first item in a `Path`'s list of name elements
  - d. the last item in a `Path`'s list of name elements
7. Which of the following statements always returns the same value as `file.exists()`?
  - a. `file.checkAccess()`
  - b. `file.checkAccess(EXISTS)`
  - c. `file.checkAccess(READ, WRITE)`
  - d. `file.checkAccess(file.exists())`
8. You cannot delete a `Path` \_\_\_\_\_.
  - a. under any circumstances
  - b. if it represents a directory
  - c. if it represents a directory that is not empty
  - d. if it represents more than five levels
9. The data hierarchy occurs in the following order from the smallest to largest piece of data: \_\_\_\_\_.
  - a. character, field, record, file
  - b. character, file, record, field
  - c. character, record, field, file
  - d. record, character, field, file
10. When records are accessed one after the other in the order in which they were stored, the file is being used as a \_\_\_\_\_ access file.
  - a. random
  - b. binary
  - c. chronological
  - d. sequential
11. If you fail to close an output file, \_\_\_\_\_.
  - a. there are usually no serious consequences
  - b. you might lose access to the written data
  - c. Java will close it for you automatically
  - d. Two of the above are correct.
12. Which of the following is true of streams?
  - a. Streams are channels through which bytes flow.
  - b. Streams always flow in two directions.
  - c. Only one stream can be open in a program at a time.
  - d. All of the above are true.

13. A buffer \_\_\_\_\_.
- a. holds bytes that are scheduled for input or output
  - b. deteriorates program performance
  - c. cannot be flushed in Java
  - d. All of the above are true.
14. `InputStream` is \_\_\_\_\_.
- a. a child of `OutputStream`
  - b. an abstract class
  - c. used for screen output as opposed to file output
  - d. All of the above are true.
15. Java's `print()` and `println()` methods are defined in the \_\_\_\_\_ class.
- a. `BufferedOutputStream`
  - b. `System`
  - c. `PrintStream`
  - d. `Print`
16. The `newOutputStream()` method \_\_\_\_\_.
- a. is defined in the `Path` class
  - b. creates a file if it does not already exist
  - c. opens a file for writing
  - d. All of the above are true.
17. Which of the following does the same thing as the `BufferedWriter` class `newLine()` method?
- a. `System.getProperty("line.separator ")`
  - b. `Path.getProperty("line.separator ")`
  - c. `System.out.println()`
  - d. `System.out.print("\n")`
18. Which of the following systems is most likely to use batch processing?
- a. an airline reservation system
  - b. payroll
  - c. point-of-sale credit checking
  - d. an e-mail application
19. Real-time applications \_\_\_\_\_.
- a. use sequential access files
  - b. use batch processing
  - c. use random access files
  - d. seldom are interactive
20. A file channel \_\_\_\_\_.
- a. can be read from
  - b. can be written to
  - c. is seekable
  - d. All of the above are true.



## Exercises

1. Create a file using any word-processing program or text editor. Write an application that displays the file's name, containing folder, size, and time of last modification. Save the file as **FileStatistics.java**.
2. Create two files using any word-processing program or text editor. Write an application that determines whether the two files are located in the same folder. Save the file as **SameFolder.java**.
3. Create a file that contains your favorite movie quote. Use a text editor such as Notepad, and save the file as **quote.txt**. Copy the file contents and paste them into a word-processing program such as Word. Save the file as **quote.docx**. Write an application that displays the sizes of the two files as well as the ratio of their sizes to each other. Save the file as **FileStatistics2.java**.
4. Write an application that determines which, if any, of the following files are stored in the folder where you have saved the exercises created in this chapter: `autoexec.bat`, `SameFolder.java`, `FileStatistics.class`, and `Hello.java`. Save the file as **FindSelectedFiles.java**.
5.
  - a. Create a program that accepts any number of first names, last names, and associated phone numbers from the keyboard and saves the data to a file. Save the program as **WritePhoneList.java**. When you execute the program, enter multiple records that have the same first name because you will search for repeated first names in part c of this exercise.
  - b. Write an application that reads the file created by the `WritePhoneList` application and displays the records. Save the file as **DisplaySavedPhoneList.java**.
  - c. Write an application that allows you to enter any first name and displays all the last names and phone numbers for records with the given first name. Display an appropriate message if the first name cannot be found in the input file. Save the file as **DisplaySelectedNumbers.java**.
6. Using a text editor, create a file that contains a list of five 4-digit account numbers. Read in each account number, and alter it to add a dash and a check digit, which is calculated by taking the remainder when the original number is divided by 7. Write the new account numbers to an output file. Save the application as **AddCheckDigit.java**.
7.
  - a. Write an application that allows a user to enter a filename and an integer representing a file position. Assume that the file is in the same folder as your executing program. Access the requested position within the file and display the next 20 characters there. Save the file as **SeekPosition.java**.
  - b. Modify the `SeekPosition` application so that instead of displaying 20 characters, the user enters the number of characters to display, beginning with the requested position. Save the file as **SeekPosition2.java**.
8.
  - a. Create an application that allows you to enter student data that consists of an ID number, first name, last name, and credit hours earned. Depending on the student's number of credit hours completed, output each record to either a

- lowerclassman file (under 60 hours completed) or an upperclassman file (60 hours or more completed). Save the program as **LowerAndUpper.java**.
- b. Expand the **LowerAndUpper** application so that it displays each record one by one from the lowerclassman file and then from the upperclassman file. Display a heading to introduce each list. For each record, display the ID number, first name, last name, credits earned, and number of additional credits needed to graduate. Assume that 120 credits are required for graduation. Save the program as **LowerAndUpperDisplay.java**.
9.
    - a. The Rochester Bank maintains customer records in a random access file. Write an application that creates 10,000 blank records and then allows the user to enter customer account information, including an account number that is 9999 or less, a last name, and a balance. Insert each new record into a data file at a location that is equal to the account number. Assume that the user will not enter invalid account numbers. Force each name to eight characters, padding it with spaces or truncating it if necessary. Also assume that the user will not enter a bank balance greater than 99,000.00. Save the file as **CreateBankFile.java**.
    - b. Create an application that uses the file created by the user in Exercise 9a and displays all existing accounts in account-number order. Save the file as **ReadBankAccountsSequentially.java**.
    - c. Create an application that uses the file created by the user in Exercise 9a and allows the user to enter an account number to view the account balance. Allow the user to view additional account balances until entering an application-terminating value. Save the file as **ReadBankAccountsRandomly.java**.
  10.
    - a. Write a program that allows you to create a file of customers for a company. The first part of the program should create an empty file suitable for writing a three-digit ID number, six-character last name, and five-digit zip code for each customer. The second half of the program accepts user input to populate the file. For this exercise, assume that the user will correctly enter ID numbers and zip codes, but force the customer name to seven characters if it is too long or too short. Issue an error message, and do not save the record if the user tries to enter a previously used ID number. Save the program as **CreateCustomerFile.java**.
    - b. Write a program that creates a file of items carried by the company. Include a three-digit item number and up to a 20-character description for each item. Issue an error message if the user tries to store an item number that has already been used. Save the program as **CreateItemFile.java**.
    - c. Write an application that takes customer orders. Allow a user to enter a customer number and item ordered. Display an error message if the customer number does not exist in the customer file or the item does not exist in the item file; otherwise, display all the customer information and item information. Save the program as **CustomerItemOrder.java**.



## Debugging Exercise

11. Each of the following files in the Chapter.13 folder of your downloadable student files has syntax and/or logic errors. In each case, determine the problem and fix the program. After you correct the errors, save each file using the same filename preceded with Fix. For example, DebugThirteen1.java will become FixDebugThirteen1.java.
  - a. DebugThirteen1.java
  - b. DebugThirteen2.java
  - c. DebugThirteen3.java
  - d. DebugThirteen4.java

The Chapter.13 folder contains four additional data files named DebugData1.txt, DebugData2.txt, DebugData3.txt, and DebugData4.txt. These files are used by the Debug programs.

641



## Game Zone

12. In several Game Zone assignments earlier in this book, you created games similar to Hangman in which the user guesses a secret phrase by selecting a series of letters. These versions had limited appeal because each contained only a few possible phrases to guess; after playing the games a few times, the user would have memorized all the phrases. Now create a version in which any number of secret phrases can be saved to a file before the game is played. Use a text editor such as Notepad to type any number of phrases into a file, one per line. Save the file as **Phrases.txt**. Then, create a game that randomly selects a phrase from the file and allows a user to guess the phrase letter by letter. Save the game as **SecretPhraseUsingFile.java**.
13. In Chapter 8, you created a game named Quiz in which the user could respond to multiple-choice questions. Modify the game so that it stores the player's highest score from any previous game in a file and displays the high score at the start of each new game. (The first time you play the game, the high score is 0.) Save the game as **QuizUsingFile.java**.
14. Use a text editor to create a comma-delimited file of user IDs and passwords. Revise any one of the games you have created throughout this book so the user must first enter a correct ID and its associated password before playing. Save the program as **GameWithPassword.java**.

*This page intentionally left blank*

# Introduction to Swing Components

In this chapter, you will:

- ③ Understand Swing components
- ③ Use the `JFrame` class
- ③ Use the `JLabel` class
- ③ Use a layout manager
- ③ Extend the `JFrame` class
- ③ Add `JTextFields`, `JButtons`, and tool tips to a `JFrame`
- ③ Learn about event-driven programming
- ③ Understand Swing event listeners
- ③ Use the `JCheckBox`, `ButtonGroup`, and `JComboBox` classes

## Understanding Swing Components

Computer programs usually are more user friendly (and more fun to use) when they contain user interface (UI) components. **UI components** are buttons, text fields, and other components with which the user can interact. Java's creators have packaged a number of prewritten components in the `Swing` package. **Swing components** are UI elements such as dialog boxes and buttons; you can usually recognize their names because they begin with *J*.



Swing components were named after a musical style that was popular in the 1940s. The name is meant to imply that the components have style and pizzazz. You have already used the `JOptionPane` component that is part of the `Swing` class. The `Swing` classes are part of a more general set of UI programming capabilities that are collectively called the **Java Foundation Classes**, or **JFC**. JFC includes `Swing` component classes and selected classes from the `java.awt` package.



In early versions of Java, components had simple names, such as `Frame` and `Button`. The components created from these original classes did not have a consistent appearance when used with different browsers and operating systems. When Java's creators designed new, improved classes, they needed new names for the classes, so they used a *J* in front of each new class name. Hence, `Swing` components have names like `JFrame`, `JButton`, `JScrollbar`, `JOptionPane`, and so on.

UI components are also called *controls* or *widgets*. Each `Swing` component is a descendant of a `JComponent`, which in turn inherits from the `java.awt.Container` class. You can insert the statement `import javax.swing.*`; at the beginning of your Java program files so you can take advantage of the `Swing` UI components and their methods. When you import `Swing` classes, you use the `javax.swing` package instead of `java.swing`. The *x* originally stood for *extension*, so named because the `Swing` classes were an extension of the original Java language specifications.



Almost all `Swing` components are said to be **lightweight components** because they are written completely in Java and do not have to rely on the local operating system code. This means the components are not “weighed down” by having to interact with the operating system (for example, Windows or Macintosh) in which the application is running. Some `Swing` components, such as `JFrames`, are known as **heavyweight components** because they do require interaction with the local operating system. A lightweight component reuses the native (original) window of its closest heavyweight ancestor; a heavyweight component has its own opaque native window. The only heavyweight components used in `Swing` are `swing.JFrame`, `swing.JDialog`, `swing.JWindow`, `swing.JApplet`, `awt.Component`, `awt.Container`, and `awt.JComponent`.

When you use `Swing` components, you usually place them in containers. A **container** is a type of component that holds other components so you can treat a group of them as a single entity. Containers are defined in the `Container` class. Often, a container takes the form of a window that you can drag, resize, minimize, restore, and close.

As you know from reading about inheritance in Chapters 10 and 11, all Java classes descend from the `Object` class. The `Component` class is a child of the `Object` class, and the `Container` class is a child of the `Component` class. Therefore, every `Container` object “is a” `Component`, and every `Component` object (including every `Container`) “is an” `Object`. The `Container` class is also a parent class, and the `Window` class is a child of `Container`. However, Java programmers rarely use `Window` objects because the `Window` subclass `Frame` and its child, the `Swing` component `JFrame`, both allow you to create more useful objects. `Window` objects do not have title bars or borders, but `JFrame` objects do.

## TWO TRUTHS & A LIE

### Understanding Swing Components

1. Swing components are elements such as buttons; you can usually recognize their names because they contain the word *Swing*.
2. Each Swing component is a descendant of a `JComponent`, which in turn inherits from the `java.awt.Container` class.
3. You insert the import statement `import javax.swing.*;` at the beginning of your Java program files so you can use Swing components.

The false statement is #1. You can usually recognize Swing component names because they begin with *J*.

## Using the JFrame Class

You usually create a `JFrame` so that you can place other objects within it for display. Figure 14-1 shows the `JFrame`'s inheritance tree. Recall that the `Object` class is defined in the `java.lang` package, which is imported automatically every time you write a Java program. However, `Object`'s descendants (shown in Figure 14-1) are not automatically imported.

```

java.lang.Object
  |-- java.awt.Component
        |-- java.awt.Container
              |-- java.awt.Window
                    |-- java.awt.Frame
                          |-- javax.swing.JFrame

```

**Figure 14-1** Relationship of the `JFrame` class to its ancestors

The `JFrame` class has four constructors:

- `JFrame()` constructs a new frame that initially is invisible and has no title.
- `JFrame(String title)` creates a new, initially invisible `JFrame` with the specified title.
- `JFrame(GraphicsConfiguration gc)` creates a `JFrame` in the specified `GraphicsConfiguration` of a screen device with a blank title. (You will learn about the `GraphicsConfiguration` class as you continue to study Java.)
- `JFrame(String title, GraphicsConfiguration gc)` creates a `JFrame` with the specified title and the specified `GraphicsConfiguration` of a screen.

You can construct a `JFrame` as you do other objects, using the class name, an identifier, the assignment operator, the `new` operator, and a constructor call. For example, the following two statements construct two `JFrames`: one with the title “Hello” and another with no title:

```
JFrame firstFrame = new JFrame("Hello");
JFrame secondFrame = new JFrame();
```

After you create a `JFrame` object, you can use the now-familiar object-dot-method format you have used with other objects to call methods that manipulate a `JFrame`'s features. Table 14-1 describes some useful `JFrame` class methods.

646



The methods in Table 14-1 represent only a small portion of the available methods you can use with a `JFrame`. Each of the methods listed in Table 14-1 is inherited from either `JFrame`'s `Component` or `Frame` parent class. These classes contain many useful methods in addition to the few listed here. You can read the documentation for all the methods at <http://java.sun.com>.

Method	Purpose
<code>void setTitle(String)</code>	Sets a <code>JFrame</code> 's title using the <code>String</code> argument
<code>void setSize(int, int)</code>	Sets a <code>JFrame</code> 's size in pixels with the width and height as arguments
<code>void setSize(Dimension)</code>	Sets a <code>JFrame</code> 's size using a <code>Dimension</code> class object; the <code>Dimension(int, int)</code> constructor creates an object that represents both a width and a height
<code>String getTitle()</code>	Returns a <code>JFrame</code> 's title
<code>void setResizable(boolean)</code>	Sets the <code>JFrame</code> to be resizable by passing <code>true</code> to the method, or sets the <code>JFrame</code> not to be resizable by passing <code>false</code> to the method
<code>boolean isResizable()</code>	Returns <code>true</code> or <code>false</code> to indicate whether the <code>JFrame</code> is resizable
<code>void setVisible(boolean)</code>	Sets a <code>JFrame</code> to be visible using the <code>boolean</code> argument <code>true</code> and invisible using the <code>boolean</code> argument <code>false</code>
<code>void setBounds(int, int, int, int)</code>	Overrides the default behavior for the <code>JFrame</code> to be positioned in the upper-left corner of the computer screen's desktop; the first two arguments are the horizontal and vertical positions of the <code>JFrame</code> 's upper-left corner on the desktop, and the final two arguments set the width and height

**Table 14-1** Useful methods inherited by the `JFrame` class

Assuming you have declared a `JFrame` named `firstFrame`, you can use the following statements to set the `firstFrame` object's size to 250 pixels horizontally by 100 pixels vertically and set the `JFrame`'s title to display a `String` argument. **Pixels** are the picture elements, or tiny dots of light, that make up the image on your computer monitor.

```
firstFrame.setSize(250, 100);
firstFrame.setTitle("My frame");
```

When you set a `JFrame`'s size, you do not have the full area available to use because part of the area is consumed by the `JFrame`'s title bar and borders.



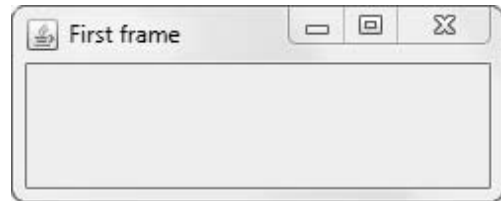
Figure 14-2 shows an application that creates a small, empty JFrame.

```
import javax.swing.*;
public class JFrame1
{
    public static void main(String[] args)
    {
        JFrame aFrame = new JFrame("First frame");
        aFrame.setSize(250, 100);
        aFrame.setVisible(true);
    }
}
```

647

**Figure 14-2** The JFrame1 application

The application in Figure 14-2 produces the JFrame shown in Figure 14-3. It resembles frames that you have probably seen when using different UI programs you have downloaded or purchased. One reason to use similar frame objects in your own programs is that users are already familiar with the frame environment. When users see frames on their computer screens, they expect to see a title bar at the top containing text information (such as “First frame”). Users also expect to see Minimize, Maximize or Restore, and Close buttons in the frame’s upper-right corner. Most users assume that they can change a frame’s size by dragging its border or reposition the frame on their screen by dragging the frame’s title bar to a new location. The JFrame in Figure 14-3 has all of these capabilities.



**Figure 14-3** Output of the JFrame1 application

In the application in Figure 14-2, all three statements in the `main()` method are important. After you instantiate `aFrame`, if you do not use `setVisible(true)`, you do not see the JFrame, and if you do not set its size, you see only the title bar of the JFrame because the JFrame size is  $0 \times 0$  by default. It might seem unusual that the default state for a JFrame is invisible. However, consider that you might want to construct a JFrame in the background while other actions are occurring and that you might want to make it visible later, when appropriate (for example, after the user has taken an action such as selecting an option). To make a frame visible, some Java programmers use the `show()` method instead of the `setVisible()` method.

When a user closes a JFrame by clicking the Close button in the upper-right corner, the default behavior is for the JFrame to become hidden and for the application to keep running. This makes sense when there are other tasks for the program to complete after the main frame is closed—for example, displaying additional frames, closing open data files, or printing an activity report. However, when a JFrame serves as a Swing application’s main user interface (as happens frequently in interactive programs), you usually want the program to exit when the user clicks

Close. To change this behavior, you can call a `JFrame`'s `setDefaultCloseOperation()` method and use one of the following four values as an argument:

- `JFrame.EXIT_ON_CLOSE` exits the program when the `JFrame` is closed. This value is used in Figure 14-7 and other examples later in this chapter.
- `WindowConstants.DISPOSE_ON_CLOSE` closes the frame, disposes of the `JFrame` object, and keeps running the application.
- `WindowConstants.DO_NOTHING_ON_CLOSE` keeps the `JFrame` open and continues running. In other words, it disables the Close button.
- `WindowConstants.HIDE_ON_CLOSE` closes the `JFrame` and continues running; this is the default operation that you frequently want to override.

When you execute an application in which you have forgotten to exit when the `JFrame` is closed, you can end the program by typing `Ctrl+C`.



Each of the four usable `setDefaultCloseOperation()` arguments represents an integer; for example, the value of `JFrame.EXIT_ON_CLOSE` is 3. However, it is easier to remember the constant names than the numeric values they represent, and other programmers more easily understand your intentions if you use the named constant identifier.

## Customizing a `JFrame`'s Appearance

The appearance of the `JFrame` in Figure 14-3 is provided by the operating system in which the program is running (in this case, Windows). For example, the coffee-cup icon in the frame's title bar and the Minimize, Restore, and Close buttons look and act as they do in other Windows applications. The icon and buttons are known as **window decorations**; by default, window decorations are supplied by the operating system. However, you can request that Java's look and feel provide the decorations for a frame. A **look and feel** is the default appearance and behavior of any user interface.

Optionally, you can set a `JFrame`'s look and feel using the `setDefaultLookAndFeelDecorated()` method. For example, Figure 14-4 shows an application that calls this method.

```
import javax.swing.*;
public class JFrame2
{
    public static void main(String[] args)
    {
        JFrame.setDefaultLookAndFeelDecorated(true);
        JFrame aFrame = new JFrame("Second frame");
        aFrame.setSize(250, 100);
        aFrame.setVisible(true);
    }
}
```

**Figure 14-4** The `JFrame2` class



You can provide a custom icon for a frame instead of using your operating system's default icon or the Java look-and-feel icon. For details, go to <http://java.sun.com> and search for "How to Make Frames."

The program in Figure 14-4 differs from Figure 14-2 only in the shaded areas, which show the class name, the text in the title bar, and the look-and-feel statement. Figure 14-5 shows the output. If you compare the frame in Figure 14-5 with the one in Figure 14-3, you can see that Java's look and feel has similar features to that of Windows, but their appearance is different. Java's look and feel is also known by the name "Metal."

649



**Figure 14-5** Output of the JFrame2 application



Look and feel is a legal issue because some software companies claim that competitors are infringing on their copyright protection by copying the look and feel of their products. As of this writing, the courts have not made a definitive ruling on this matter.



Watch the video *Using the JFrame class*.

## TWO TRUTHS & A LIE

### Using the JFrame Class

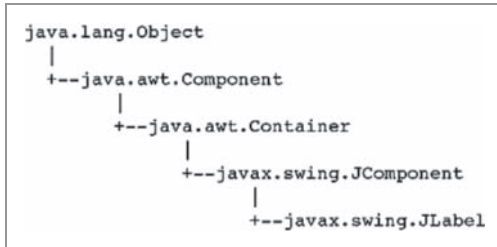
1. The JFrame class contains overloaded constructors; for example, you can specify a title or not.
2. An advantage of using a JFrame is that it resembles traditional frames that people are accustomed to using.
3. When a user closes a JFrame by clicking the Close button in the upper-right corner, the default behavior is for the application to end.

The false statement is #3. When a user closes a JFrame by clicking the Close button in the upper-right corner, the default behavior is for the JFrame to become hidden and for the application to keep running.

## Using the JLabel Class

One of the components you might want to place on a JFrame is a JLabel. **JLabel** is a built-in Java Swing class that holds text you can display. The inheritance hierarchy of the JLabel class is shown in Figure 14-6.

650



**Figure 14-6** The JLabel class inheritance hierarchy

Available constructors for the JLabel class include the following:

- JLabel() creates a JLabel instance with no image and with an empty string for the title.
- JLabel(Icon image) creates a JLabel instance with the specified image.
- JLabel(Icon image, int horizontalAlignment) creates a JLabel instance with the specified image and horizontal alignment.
- JLabel(String text) creates a JLabel instance with the specified text.
- JLabel(String text, Icon icon, int horizontalAlignment) creates a JLabel instance with the specified text, image, and horizontal alignment.
- JLabel(String text, int horizontalAlignment) creates a JLabel instance with the specified text and horizontal alignment.

For example, you can create a JLabel named `greeting` that holds the words “Good day” by writing the following statement:

```
JLabel greeting = new JLabel("Good day");
```

You then can add the `greeting` object to the JFrame object named `aFrame` using the **add()** method as follows:

```
aFrame.add(greeting);
```

Figure 14-7 shows an application in which a JFrame is created and its size, visibility, and close operation are set. Then a JLabel is created and added to the JFrame. Figure 14-8 shows the output.

The counterpart to the `add()` method is the **remove()** method. The following statement removes `greeting` from `aFrame`:

```
aFrame.remove(greeting);
```

```
import javax.swing.*;
public class JFrame3
{
    public static void main(String[] args)
    {
        final int FRAME_WIDTH = 250;
        final int FRAME_HEIGHT = 100;
        JFrame aFrame = new JFrame("Third frame");
        aFrame.setSize(FRAME_WIDTH, FRAME_HEIGHT);
        aFrame.setVisible(true);
        aFrame.setDefaultCloseOperation(JFrame.EXIT_ON_CLOSE);
        JLabel greeting = new JLabel("Good day");
        aFrame.add(greeting);
    }
}
```

Figure 14-7 The JFrame3 class

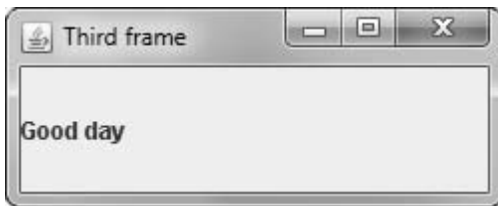


Figure 14-8 Output of the JFrame3 application

If you add or remove a component from a container after it has been made visible, you should also call the `invalidate()`, `validate()`, and `repaint()` methods, or else you will not see the results of your actions. Each performs slightly different functions, but all three together guarantee that the results of changes in your layout will take effect. The `invalidate()` and `validate()` methods are part of the `Container` class, and the `repaint()` method is part of the `Component` class.



If you add or remove a component in a `JFrame` during construction, you do not have to call `repaint()` if you later alter the component—for example, by changing its text. You only need to call `repaint()` if you add or remove a component after construction. You will learn more about the `repaint()` method in the *Graphics* chapter.

You can change the text in a `JLabel` by using the `Component` class **`setText()` method** with the `JLabel` object and passing a `String` to it. For example, the following code changes the value displayed in the greeting `JLabel`:

```
greeting.setText("Howdy");
```

You can retrieve the text in a `JLabel` (or other `Component`) by using the **`getText()` method**, which returns the currently stored `String`.

## Changing a JLabel's Font

If you use the Internet and a Web browser to visit Web sites, you probably are not very impressed with the simple application displayed in Figure 14-8. You might think that the string “Good day” is plain and lackluster. Fortunately, Java provides you with a **Font class** from which you can create an object that holds typeface and size information. The **setFont()** method requires a Font object argument. To construct a Font object, you need three arguments: typeface, style, and point size.

- The **typeface argument** to the Font constructor is a String representing a font. Common fonts have names such as Arial, Century, Monospaced, and Times New Roman. The typeface argument in the Font constructor is only a request; the system on which your program runs might not have access to the requested font, and if necessary, it substitutes a default font.
- The **style argument** applies an attribute to displayed text and is one of three values: Font.PLAIN, Font.BOLD, or Font.ITALIC.
- The **point size argument** is an integer that represents about 1/72 of an inch. Printed text is commonly 12 points; a headline might be 30 points.



In printing, point size defines a measurement between lines of text in a single-spaced text document. The point size is based on typographic points, which are approximately 1/72 of an inch. Java adopts the convention that one point on a display is equivalent to one unit in user coordinates. For more information, see the Font documentation at <http://java.sun.com>.

To give a JLabel object a new font, you can create a Font object, as in the following:

```
Font headlineFont = new Font("Monospaced", Font.BOLD, 36);
```

The typeface name is a String, so you must enclose it in double quotation marks.

You can use the setFont() method to assign the Font to a JLabel with a statement such as: `greeting.setFont(headlineFont);`

Figure 14-9 shows a class named JFrame4. All the changes from JFrame3 are shaded.

```
import javax.swing.*;
import java.awt.*;
public class JFrame4
{
    public static void main(String[] args)
    {
        final int FRAME_WIDTH = 250;
        final int FRAME_HEIGHT = 100;
        Font headlineFont = new Font("Arial", Font.BOLD, 36);
        JFrame aFrame = new JFrame("Fourth frame");
        aFrame.setSize(FRAME_WIDTH, FRAME_HEIGHT);
    }
}
```

**Figure 14-9** The JFrame4 program (continues)

(continued)

```

aFrame.setVisible(true);
aFrame.setDefaultCloseOperation(JFrame.EXIT_ON_CLOSE);
JLabel greeting = new JLabel("Good day");
greeting.setFont(headlineFont);
aFrame.add(greeting);
    }
}

```

**Figure 14-9** The JFrame4 program

The program in Figure 14-9 includes a new import statement for the package that contains the `Font` class. The program contains a `Font` object named `headlineFont` that is applied to the greeting. Figure 14-10 shows the execution of the `JFrame4` program; the greeting appears in a 36-point, bold, Arial font.



**Figure 14-10** Output of the JFrame4 program

You are not required to provide an identifier for a `Font`. For example, you could omit the shaded statement that declares `headlineFont` in Figure 14-9 and set the `greeting` `Font` with the following statement that uses an anonymous `Font` object:

```
greeting.setFont(new Font("Arial", Font.BOLD, 36));
```

## TWO TRUTHS & A LIE

### Using the JLabel Class

1. `JLabel` is a built-in Java Swing class that holds text you can display.
2. You can change a `JLabel`'s text by using its `JFrame`'s name, a dot, and the `add()` method, and then using the desired text as the argument to the method.
3. If you add or remove a component from a container after it has been made visible, you should also call the `validate()` and `repaint()` methods, or else you will not see the results of your actions.

The false statement is #2. You change a `JLabel`'s text using the `setText()` method, including the new text as the argument. You add a `JLabel` to a `JFrame` by using the `JFrame`'s name, a dot, and the `add()` method, and then by using the `JLabel`'s name as an argument to the method.

## Using a Layout Manager

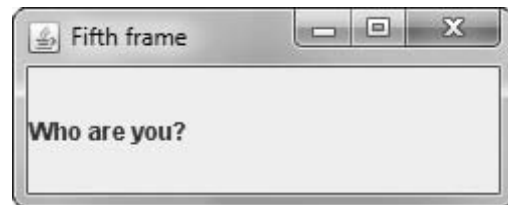
When you want to add multiple components to a `JFrame` or other container, you usually need to provide instructions for the layout of the components. For example, Figure 14-11 shows an application in which two `JLabels` are created and added to a `JFrame` in the final shaded statements.

```
import javax.swing.*;
import java.awt.*;
public class JFrame5
{
    public static void main(String[] args)
    {
        final int FRAME_WIDTH = 250;
        final int FRAME_HEIGHT = 100;
        JFrame aFrame = new JFrame("Fifth frame");
        aFrame.setSize(FRAME_WIDTH, FRAME_HEIGHT);
        aFrame.setVisible(true);
        aFrame.setDefaultCloseOperation(JFrame.EXIT_ON_CLOSE);
        JLabel greeting = new JLabel("Hello");
        JLabel greeting2 = new JLabel("Who are you?");
        aFrame.add(greeting);
        aFrame.add(greeting2);
    }
}
```

**Figure 14-11** The `JFrame5` program

Figure 14-12 shows the output of the application in Figure 14-11. Although two `JLabels` are added to the frame, only the last one added is visible. The second `JLabel` has been placed on top of the first one, totally obscuring it. If you continued to add more `JLabels` to the program, only the last one added to the `JFrame` would be visible.

To place multiple components at specified positions in a container so they do not hide each other, you must explicitly use a **layout manager**—a class that controls component positioning. The normal (default) behavior of a `JFrame` is to use a layout format named `BorderLayout`. A **BorderLayout**, created by using the `BorderLayout` class, divides a container into regions. When you do not specify a region in which to place a component (as the `JFrame5` program fails to do), all the components are placed in the same region, and they obscure each other.



**Figure 14-12** Output of the `JFrame5` program



When you use a `FlowLayout` instead of a `BorderLayout`, components do not lie on top of each other. Instead, the **flow layout manager** places components in a row, and when a row is filled, components automatically spill into the next row.

Three constants are defined in the `FlowLayout` class that specify how components are positioned in each row of their container. These constants are `FlowLayout.LEFT`, `FlowLayout.RIGHT`, and `FlowLayout.CENTER`. For example, to create a layout manager named `flow` that positions components to the right, you can use the following statement:

```
FlowLayout flow = new FlowLayout(FlowLayout.RIGHT);
```

If you do not specify how components are laid out, by default they are centered in each row.

Suppose you create a `FlowLayout` object named `flow` as follows:

```
FlowLayout flow = new FlowLayout();
```

Then the layout of a `JFrame` named `aFrame` can be set to the newly created `FlowLayout` using the statement:

```
aFrame.setLayout(flow);
```

A more compact syntax that uses an anonymous `FlowLayout` object is:

```
aFrame.setLayout(new FlowLayout());
```

Figure 14-13 shows an application in which the `JFrame`'s layout manager has been set so that multiple components are visible.

```
import javax.swing.*;
import java.awt.*;
public class JFrame6
{
    public static void main(String[] args)
    {
        final int FRAME_WIDTH = 250;
        final int FRAME_HEIGHT = 100;
        JFrame aFrame = new JFrame("Sixth frame");
        aFrame.setSize(FRAME_WIDTH, FRAME_HEIGHT);
        aFrame.setVisible(true);
        aFrame.setDefaultCloseOperation(JFrame.EXIT_ON_CLOSE);
        JLabel greeting = new JLabel("Hello");
        JLabel greeting2 = new JLabel("Who are you?");
        aFrame.setLayout(new FlowLayout());
        aFrame.add(greeting);
        aFrame.add(greeting2);
    }
}
```

**Figure 14-13** The `JFrame6` program

Figure 14-14 shows the execution of the `JFrame6` program. Because a `FlowLayout` is used, the two `JLabel`s appear side by side. If there were more `JLabel`s or other components, they would continue to be placed side by side across the `JFrame` until there was no more room. Then, the additional components would be placed in a new row beneath the first row of components.



**Figure 14-14** Output of the `JFrame6` program



Other layout managers allow you to position components in a container more precisely. You will learn about these in the *Graphics* chapter. The examples in this chapter will use `FlowLayout` because it is the easiest of the layout managers to use.



Watch the video *Using a Layout Manager*.

## TWO TRUTHS & A LIE

### Using a Layout Manager

1. If you do not provide a layout manager for a `JFrame`, you cannot add multiple components to it.
2. The normal (default) behavior of a `JFrame` is to use a layout format named `BorderLayout`.
3. The flow layout manager places components in a row, and when a row is filled, it automatically spills components into the next row.

The false statement is #1. If you do not provide a layout manager for a `JFrame`, you can add multiple components to it, but only the most recently added one is visible.

## Extending the `JFrame` Class

You can instantiate a simple `JFrame` object within an application's `main()` method or with any other method of any class you write. Alternatively, you can create your own class that descends from the `JFrame` class. The advantage of creating a child class of `JFrame` is that you can set the `JFrame`'s properties within your object's constructor; then, when you create your `JFrame` child object, it is automatically endowed with the features you have specified, such as title, size, and default close operation.

You already know that you create a child class by using the keyword `extends` in the class header, followed by the parent class name. You also know that you can call the parent class's

constructor using the keyword `super`, and that when you call `super()`, the call must be the first statement in the constructor. For example, the `JMyFrame` class in Figure 14-15 extends `JFrame`. Within the `JMyFrame` constructor, the `super()` `JFrame` constructor is called; it accepts a `String` argument to use as the `JFrame`'s title. (Alternatively, the `setTitle()` method could have been used.) The `JMyFrame` constructor also sets the size, visibility, and default close operation for every `JMyFrame`. Each of the methods—`setSize()`, `setVisible()`, and `setDefaultCloseOperation()`—appears in the constructor in Figure 14-15 without an object, because the object is the current `JMyFrame` being constructed. Each of the three methods could be preceded with a `this` reference with exactly the same meaning. That is, within the `JMyFrame` constructor, the following two statements have identical meanings:

```
setSize(WIDTH, HEIGHT);  
this.setSize(WIDTH, HEIGHT);
```

Each statement sets the size of “this” current `JMyFrame` instance.

```
import javax.swing.*;  
public class JMyFrame extends JFrame  
{  
    final int WIDTH = 200;  
    final int HEIGHT = 120;  
    public JMyFrame()  
    {  
        super("My frame");  
        setSize(WIDTH, HEIGHT);  
        setVisible(true);  
        setDefaultCloseOperation(JFrame.EXIT_ON_CLOSE);  
    }  
}
```

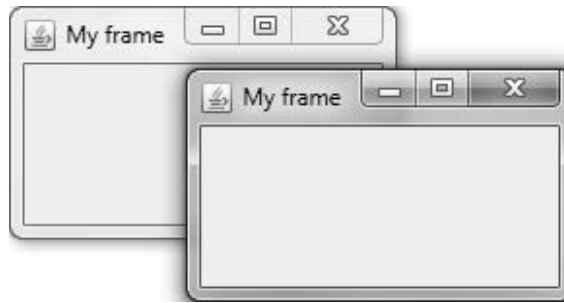
**Figure 14-15** The `JMyFrame` class

Figure 14-16 shows an application that declares two `JMyFrame` objects. Each has the same set of attributes, determined by the `JMyFrame` constructor.

```
public class CreateTwoJMyFrameObjects  
{  
    public static void main(String[] args)  
    {  
        JFrame myFrame = new JMyFrame();  
        JFrame mySecondFrame = new JMyFrame();  
    }  
}
```

**Figure 14-16** The `CreateTwoJMyFrameObjects` application

When you execute the application in Figure 14-16, the two `JMyFrame` objects are displayed with the second one on top of, or obscuring, the first. Figure 14-17 shows the output of the `CreateTwoJMyFrameObjects` application after the top `JMyFrame` has been dragged to partially expose the bottom one.



**Figure 14-17** Output of the `CreateTwoJMyFrameObjects` application after dragging the top frame



You could use the `setBounds()` method with one of the `JMyFrame` objects that produces the output in Figure 14-17 so that you don't have to move one `JMyFrame` object to view the other. See Table 14-1 for details. The `Object` class also includes a `setLocation()` method you can use with a `JFrame`. To use this method, you provide horizontal and vertical position values as method arguments. You will learn more about the `setLocation()` method in the chapter *Applets, Images, and Sound*.



You exit the application when you click the Close button on either of the two `JMyFrame` objects shown in Figure 14-17. Each object has the same default close operation because each uses the same constructor that specifies this operation. To allow only one `JMyFrame` to control the program's exit, you could use the `setDefaultCloseOperation()` method with one or both of the objects in the application to change its close behavior. For example, you could use `DISPOSE_ON_CLOSE` to dismiss one of the frames but keep the application running.

When you extend a `JFrame` to create a new custom class, you must remember to make decisions as to which attributes you want to set within the class and which you want to leave to the applications that will use the class. For example, you can place the `setVisible()` statement within the `JFrame` child class constructor (using either an explicit or implied `this` reference), or you can allow the application to use a `setVisible()` statement (using the name of an instantiated object followed by a dot and the method name). Either one works, but if you fail to do either, the frame will not be visible.



Programmers frequently place a `main()` method within a class such as `JMyFrame`. Then the class provides the option to be used to instantiate objects, as in the `CreateTwoJMyFrameObjects` application, or to be used to execute as a program that creates an object.

## TWO TRUTHS &amp; A LIE

## Extending the JFrame Class

1. The advantage of creating a child class of JFrame is that you can set the JFrame's properties within your object's constructor so it is automatically endowed with the features that you have specified.
2. When a class descends from JFrame, you can use `super()` or `setTitle()` to set the title within any of the child's methods.
3. When you extend a JFrame to create a new custom class, you can decide which attributes you want to set within the class and which you want to leave to the applications that will use the class.

The false statement is #2. When a class descends from JFrame, you can use `super()` or `setTitle()` to set the title within the child's constructor. However, `super()` does not work in other methods.

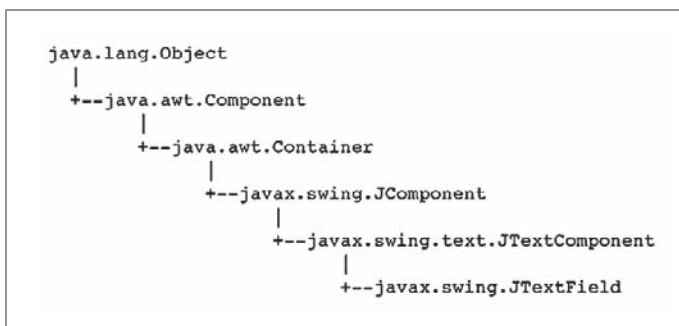
659

## Adding JTextFields, JButtons, and Tool Tips to a JFrame

In addition to including JLabel objects, JFrames often contain other window features, such as JTextFields, JButtons, and tool tips.

### Adding JTextFields

A **JTextField** is a component into which a user can type a single line of text data. (Text data comprises any characters you can enter from the keyboard, including numbers and punctuation.) Figure 14-18 shows the inheritance hierarchy of the JTextField class.



**Figure 14-18** The JTextField class inheritance hierarchy

Typically, a user types a line into a JTextField and then presses Enter on the keyboard or clicks a button with the mouse to enter the data. You can construct a JTextField object using one of several constructors:

- `public JTextField()` constructs a new `JTextField`.
- `public JTextField(int columns)` constructs a new, empty `JTextField` with a specified number of columns.
- `public JTextField(String text)` constructs a new `JTextField` initialized with the specified text.
- `public JTextField(String text, int columns)` constructs a new `JTextField` initialized with the specified text and columns.

For example, to provide a `JTextField` that allows enough room for a user to enter approximately 10 characters, you can code the following:

```
JTextField response = new JTextField(10);
```

To add the `JTextField` named `response` to a `JFrame` named `frame`, you write:

```
frame.add(response);
```

The number of characters a `JTextField` can display depends on the font being used and the actual characters typed. For example, in most fonts, 'w' is wider than 'i', so a `JTextField` of size 10 using the Arial font can display 24 'i' characters, but only eight 'w' characters.

Try to anticipate how many characters your users might enter when you create a `JTextField`. The user can enter more characters than those that display, but the extra characters scroll out of view. It can be disconcerting to try to enter data into a field that is not large enough. It is usually better to overestimate than underestimate the size of a text field.

Several other methods are available for use with `JTextFields`. The `setText()` method allows you to change the text in a `JTextField` (or other `Component`) that has already been created, as in the following:

```
response.setText("Thank you");
```

After a user has entered text in a `JTextField`, you can clear it out with a statement such as the following, which assigns an empty string to the text:

```
response.setText("");
```

The `getText()` method allows you to retrieve the `String` of text in a `JTextField` (or other `Component`), as in:

```
String whatUserTyped = response.getText();
```

When a `JTextField` has the capability of accepting keystrokes, the `JTextField` is **editable**. A `JTextField` is editable by default. If you do not want the user to be able to enter data in a `JTextField`, you can send a `boolean` value to the **`setEditable()` method** to change the `JTextField`'s editable status. For example, if you want to give a user a limited number of chances to answer a question correctly, you can count data entry attempts and then prevent the user from replacing or editing the characters in the `JTextField` by using a statement similar to the following:

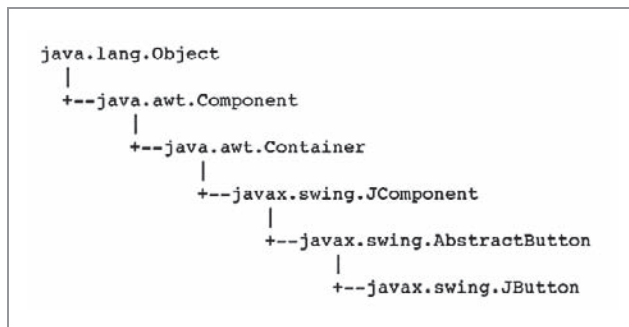
```
if(attempts > LIMIT)
    response.setEditable(false);
```

## Adding JButtons

A **JButton** is a **Component** the user can click with a mouse to make a selection. A **JButton** is even easier to create than a **JTextField**. There are five **JButton** constructors:

- `public JButton()` creates a button with no set text.
- `public JButton(Icon icon)` creates a button with an icon of type **Icon** or **ImageIcon**.
- `public JButton(String text)` creates a button with text.
- `public JButton(String text, Icon icon)` creates a button with initial text and an icon of type **Icon** or **ImageIcon**.
- `public JButton(Action a)` creates a button in which properties are taken from the **Action** supplied. (**Action** is a Java class.)

The inheritance hierarchy of the **JButton** class is shown in Figure 14-19.



**Figure 14-19** The **JButton** class inheritance hierarchy

To create a **JButton** with the label “Press when ready”, you can write the following:

```
JButton readyJButton = new JButton("Press when ready");
```

You can add a **JButton** to a **JFrame** (or other container) using the `add()` method. You can change a **JButton**’s label with the `setText()` method, as in:

```
readyJButton.setText("Don't press me again!");
```

You can retrieve the text from a **JButton** and assign it to a **String** object with the `getText()` method, as in:

```
String whatsOnJButton = readyJButton.getText();
```

Figure 14-20 shows a class that extends **JFrame** and holds several components. As the components (two **JLabels**, a **JTextField**, and a **JButton**) are added to the **JFrame**, they are placed from left to right in horizontal rows across the **JFrame**’s surface. Figure 14-21 shows the program that instantiates an instance of the **JFrame**.

```
import javax.swing.*;
import java.awt.*;
public class JFrameWithManyComponents extends JFrame
{
    final int FRAME_WIDTH = 300;
    final int FRAME_HEIGHT = 150;
    public JFrameWithManyComponents()
    {
        super("Demonstrating many components");
        setSize(FRAME_WIDTH, FRAME_HEIGHT);
        setDefaultCloseOperation(JFrame.EXIT_ON_CLOSE);
        JLabel heading = new JLabel("This frame has many components");
        heading.setFont(new Font("Arial", Font.BOLD, 16));
        JLabel namePrompt = new JLabel("Enter your name:");
        JTextField nameField = new JTextField(12);
        JButton button = new JButton("Click to continue");
        setLayout(new FlowLayout());
        add(heading);
        add(namePrompt);
        add(nameField);
        add(button);
    }
}
```

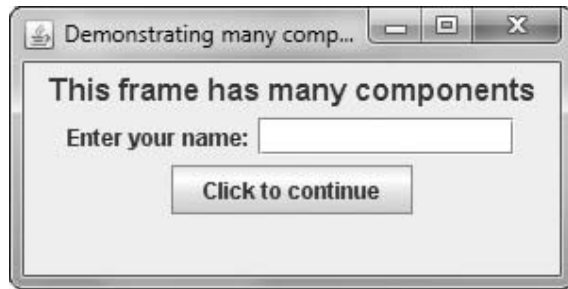
Figure 14-20 The JFrameWithManyComponents class

```
public class ComponentDemo
{
    public static void main(String[] args)
    {
        JFrameWithManyComponents frame =
            new JFrameWithManyComponents();
        frame.setVisible(true);
    }
}
```

Figure 14-21 A ComponentDemo application that instantiates a JFrameWithManyComponents



When you execute the `ComponentDemo` program, the `JFrame` contains all the components that were added in the frame's constructor, as shown in Figure 14-22. A user can minimize or restore the frame and can alter its size by dragging the frame borders. The user can type characters in the `JTextField` and can click the `JButton`. When the button is clicked, it appears to be pressed just like buttons you have used in professional applications. However, when the user types characters or clicks the button, no resulting actions occur because code has not yet been written to handle those user-initiated events.



**Figure 14-22** Execution of the `ComponentDemo` program

## Using Tool Tips

**Tool tips** are popup windows that can help a user understand the purpose of components in an application; the tool tip appears when a user hovers the mouse pointer over the component. You define the text to be displayed in a tool tip by using the `setToolTipText()` method and passing an appropriate `String` to it. For example, in the `JFrameWithManyComponents` program in Figure 14-20, you can add a tool tip to the button component by using the following statement in the `JFrame` constructor:

```
button.setToolTipText("Click this button");
```

Figure 14-23 shows the result when the `JFrame` is displayed and the user's mouse pointer is placed over the button.



The `JFrameWithToolTip.java` file in your downloadable student files contains a revised version of `JFrameWithManyComponents` with the tool tip added. The `ToolTipDemo.java` file contains an application that instantiates a `JFrameWithToolTip` object.



**Figure 14-23** `JFrame` with added tool tip

## TWO TRUTHS & A LIE

### Adding JTextFields, JButtons, and Tool Tips to a JFrame

1. A `JTextField` is a component into which a user can type a single line of text data; typically, a user types a line into a `JTextField` and then presses Enter on the keyboard or clicks a button with the mouse to enter the data.
2. A `JButton` is a Component the user can click with a mouse to make a selection.
3. Tool tips are the different symbols you can select to display as a cursor in your applications.

The false statement is #3. Tool tips are popup windows that can help a user understand the purpose of components in an application; the tool tip appears when a user hovers the mouse pointer over the component.

## Learning About Event-Driven Programming

An **event** occurs when a user takes action on a component, such as clicking the mouse on a `JButton` object. In an **event-driven program**, the user might initiate any number of events in any order. For example, if you use a word-processing program, you have dozens of choices at your disposal at any time. You can type words, select text with the mouse, click a button to change text to bold, click a button to change text to italic, choose a menu item, and so on. With each word-processing document you create, you choose options in any order that seems appropriate at the time. The word-processing program must be ready to respond to any event you initiate.

Within an event-driven program, a component on which an event is generated is the **source** of the event. A button that a user can click is an example of a source; a text field that a user can use to enter text is another source. An object that is interested in an event is a **listener**. Not all objects listen for all possible events—you probably have used programs in which clicking many areas of the screen has no effect. If you want an object to be a listener for an event, you must register the object as a listener for the source.

Social networking sites maintain lists of people in whom you are interested and notify you each time a person on your list posts a comment or picture. Similarly, a Java component source object (such as a button) maintains a list of registered listeners and notifies all of them when any event occurs. For example, a `JFrame` might want to be notified of any mouse click on its surface. When the listener “receives the news,” an event-handling method contained in the listener object responds to the event.



A source object and a listener object can be the same object. For example, you might program a `JButton` to change its own label when a user clicks it.

To respond to user events within any class you create, you must do the following:

- Prepare your class to accept event messages.
- Tell your class to expect events to happen.
- Tell your class how to respond to events.

## Preparing Your Class to Accept Event Messages

You prepare your class to accept button-press events by importing the `java.awt.event` package into your program and adding the phrase `implements ActionListener` to the class header. The `java.awt.event` package includes event classes with names such as `ActionEvent`, `ComponentEvent`, and `TextEvent`. `ActionListener` is an interface—a class containing a set of specifications for methods that you can use. Implementing `ActionListener` provides you with standard event method specifications that allow your listener to work with `ActionEvents`, which are the types of events that occur when a user clicks a button.



You learned to create and implement interfaces in Chapter 11. You can identify interfaces such as `ActionListener` because they use the keyword `implements`. In ordinary language, an item that is implemented is put into service, or used. Implementation has a similar meaning when applied to interfaces. In contrast, packages that are imported are brought into an application, and classes that are added onto are extended.

## Telling Your Class to Expect Events to Happen

You tell your class to expect `ActionEvents` with the **`addActionListener()` method**. If you have declared a `JButton` named `aButton`, and you want to perform an action when a user clicks `aButton`, `aButton` is the source of a message, and you can think of your class as a target to which to send a message. You learned in Chapter 4 that the `this` reference means “this current object,” so the code `aButton.addActionListener(this);` causes any `ActionEvent` messages (button clicks) that come from `aButton` to be sent to “this current object.”



Not all Events are `ActionEvents` with an `addActionListener()` method. For example, `KeyListener`s have an `addKeyListener()` method, and `FocusListener`s have an `addFocusListener()` method. Additional event types and methods are covered in more detail in the next chapter.

## Telling Your Class How to Respond to Events

The `ActionListener` interface contains the **`actionPerformed(ActionEvent e)` method** specification. When a class, such as a `JFrame`, has registered as a listener with a `Component` such as a `JButton`, and a user clicks the `JButton`, the `actionPerformed()` method executes. You implement the `actionPerformed()` method, which contains a header and a body, like all methods. You use the following header, in which `e` represents any name you choose for the Event (the `JButton` click) that initiated the notification of the `ActionListener` (which is the `JFrame`):

```
public void actionPerformed (ActionEvent e)
```

The body of the method contains any statements that you want to execute when the action occurs. You might want to perform mathematical calculations, construct new objects, produce output, or execute any other operation. For example, Figure 14-24 shows a `JFrame` containing a `JLabel` that prompts the user for a name, a `JTextField` into which the user can type a response, a `JButton` to click, and a second `JLabel` that displays the name entered by the user. The `actionPerformed()` method executes when the user clicks the `pressMe` `JButton`; within the method, the `String` that a user has typed into the `JTextField` is retrieved and stored in the `name` variable. The `name` is then used as part of a `String` that alters the second `JLabel` on the `JFrame`. Figure 14-25 shows an application that instantiates a `JHelloFrame` object and makes it visible.

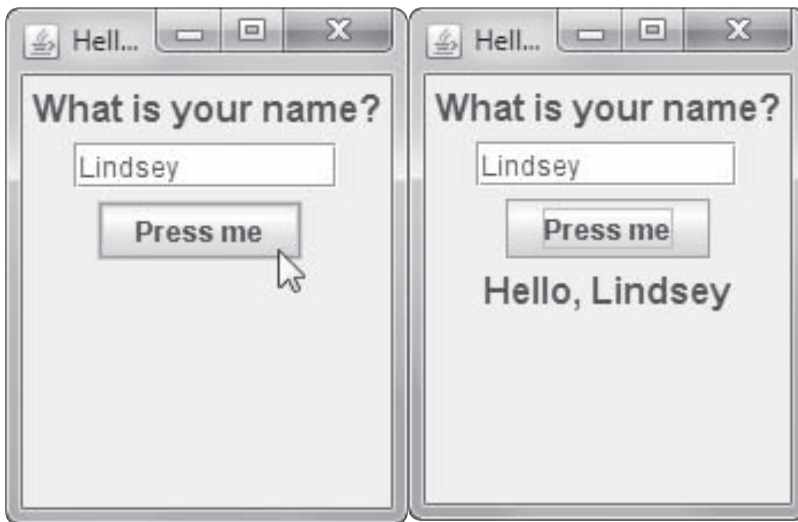
```
import javax.swing.*;
import java.awt.*;
import java.awt.event.*;
public class JHelloFrame extends JFrame implements ActionListener
{
    JLabel question = new JLabel("What is your name?");
    Font bigFont = new Font("Arial", Font.BOLD, 16);
    JTextField answer = new JTextField(10);
    JButton pressMe = new JButton("Press me");
    JLabel greeting = new JLabel("");
    final int WIDTH = 175;
    final int HEIGHT = 225;
    public JHelloFrame()
    {
        super("Hello Frame");
        setSize(WIDTH, HEIGHT);
        setLayout(new FlowLayout());
        question.setFont(bigFont);
        greeting.setFont(bigFont);
        add(question);
        add(answer);
        add(pressMe);
        add(greeting);
        setDefaultCloseOperation(JFrame.EXIT_ON_CLOSE);
        pressMe.addActionListener(this);
    }
    public void actionPerformed(ActionEvent e)
    {
        String name = answer.getText();
        String greet = "Hello, " + name;
        greeting.setText(greet);
    }
}
```

**Figure 14-24** The `JHelloFrame` class that produces output when the user clicks the `JButton`

```
public class JHelloDemo
{
    public static void main(String[] args)
    {
        JHelloFrame frame = new JHelloFrame();
        frame.setVisible(true);
    }
}
```

**Figure 14-25** An application that instantiates a `JHelloFrame` object

Figure 14-26 shows a typical execution of the `JHelloDemo` program. The user enters *Lindsey* into the `JTextField`, and the greeting with the name is displayed after the user clicks the button.



**Figure 14-26** Typical execution of the `JHelloDemo` program

When more than one component is added and registered to a `JFrame`, it might be necessary to determine which component was used to initiate an event. For example, in the `JHelloFrame` class in Figure 14-24, you might want the user to be able to see the message after either clicking the button or pressing `Enter` in the `JTextField`. In that case, you would designate both the `pressMe` button and the `answer` text field to be message sources by using the `addActionListener()` method with each, as follows:

```
pressMe.addActionListener(this);
answer.addActionListener(this);
```

These two statements make the `JFrame` (`this`) the receiver of messages from either object. The `JFrame` has only one `actionPerformed()` method, so it is the method that executes when either the `pressMe` button or the `answer` text field sends a message.

If you want different actions to occur depending on whether the user clicks the button or presses Enter, you must determine the source of the event. Within the `actionPerformed()` method, you can use the `getSource()` method of the object sent to determine which component generated the event. For example, within a method with the header `public void actionPerformed(ActionEvent e)`, `e` is an `ActionEvent`. `ActionEvent` and other event classes are part of the `java.awt.event` package and are subclasses of the `EventObject` class. To determine what object generated the `ActionEvent`, you can use the following statement:

```
Object source = e.getSource();
```

For example, if a `JFrame` contains two `JButtons` named `option1` and `option2`, you can use the decision structure in the method in Figure 14-27 to take different courses of action based on the button that is clicked. Whether an event's source is a `JButton`, `JTextField`, or other `Component`, it can be assigned to an `Object` because all components descend from `Object`.

```
void actionPerformed(ActionEvent e)
{
    Object source = e.getSource();
    if(source == option1)
        //execute these statements when user clicks option1
    else
        //execute these statements when user clicks any other option
}
```

**Figure 14-27** An `actionPerformed()` method that takes one of two possible actions

Alternatively, you can also use the `instanceof` keyword to determine the source of the event. The `instanceof` keyword is used when it is necessary to know only the component's type, rather than what component triggered the event. For example, if you want to take some action when a user enters data into any `JTextField`, but not when an event is generated by a different `Component` type, you could use the method format shown in Figure 14-28.

```
void actionPerformed(ActionEvent e)
{
    Object source = e.getSource();
    if(source instanceof JTextField)
    {
        // execute these statements when any JTextField
        // generates the event
        // but not when a JButton or other Component does
    }
}
```

**Figure 14-28** An `actionPerformed()` method that executes a block of statements when a user generates an event from any `JTextField`

## Using the `setEnabled()` Method

You probably have used computer programs in which a component becomes disabled or unusable. For example, a `JButton` might become dim and unresponsive when the programmer no longer wants you to have access to the `JButton`'s functionality. Components are enabled by default, but you can use the **`setEnabled()` method** to make a component available or unavailable by passing `true` or `false` to it, respectively. For example, Figure 14-29 shows a `JFrame` with two `JButton` objects. The one on top is enabled, but the one on the bottom has been disabled.



**Figure 14-29** A `JFrame` with an enabled `JButton` and a disabled `JButton`



Your downloadable student files contain a file named `JTwoButtons.java` that produces the `JFrame` shown in Figure 14-29.

### TWO TRUTHS & A LIE

#### Learning About Event-Driven Programming

1. Within an event-driven program, a component on which an event is generated is a listener.
2. You prepare your class to accept button-press events by importing the `java.awt.event` package into your program and adding the phrase `implements ActionListener` to the class header.
3. A class that can react to `ActionEvents` includes an `actionPerformed()` method.

The false statement is #1. Within an event-driven program, a component on which an event is generated is the source of the event, and an object that is interested in an event is a listener.

## Understanding Swing Event Listeners

Many types of listeners exist in Java, and each of these listeners can handle a specific event type. A class can implement as many event listeners as it needs—for example, a class might need to respond to both a mouse button press and a keyboard key press, so you might implement both `ActionListener` and `KeyListener` interfaces. Table 14-2 lists some event listeners and the types of events for which they are used.

Listener	Type of Events	Example
ActionListener	Action events	Button clicks
AdjustmentListener	Adjustment events	Scroll bar moves
ChangeListener	Change events	Slider is repositioned
FocusListener	Keyboard focus events	Text field gains or loses focus
ItemListener	Item events	Check box changes status
KeyListener	Keyboard events	Text is entered
MouseListener	Mouse events	Mouse clicks
MouseMotionListener	Mouse movement events	Mouse rolls
WindowListener	Window events	Window closes

**Table 14-2** Alphabetical list of some event listeners

An event occurs every time a user types a character or clicks a mouse button. Any object can be notified of an event as long as it implements the appropriate interface and is registered as an event listener on the appropriate event source. You already know that you establish a relationship between a JButton and a JFrame that contains it by using the `addActionListener()` method. Similarly, you can create relationships between other Swing components and the classes that react to users' manipulations of them. In Table 14-3, each component listed on the left is associated with a method on the right. For example, when you want a JCheckBox to respond to a user's clicks, you can use the `addItemListener()` method to register the JCheckBox as the type of object that can create an `ItemEvent`. The argument you place within the parentheses of the call to the `addItemListener()` method is the object that should respond to the event—perhaps a JFrame that contains the event-generating JCheckBox. The format is:

```
theSourceOfTheEvent.addListenerMethod(theClassThatShouldRespond);
```

Component(s)	Associated Listener-Registering Method(s)
JButton, JCheckBox, JComboBox, JTextField, and JRadioButton	<code>addActionListener()</code>
JScrollBar	<code>addAdjustmentListener()</code>
All Swing components	<code>addFocusListener()</code> , <code>addKeyListener()</code> , <code>addMouseListener()</code> , and <code>addMouseMotionListener()</code>
JButton, JCheckBox, JComboBox, and JRadioButton	<code>addItemListener()</code>
All JWindow and JFrame components	<code>addWindowListener()</code>
JSlider and JCheckBox	<code>addChangeListener()</code>

**Table 14-3** Some Swing components and their associated listener-registering methods





Any event source can have multiple listeners registered on it. Conversely, a single listener can be registered with multiple event sources. In other words, a single instance of `JCheckBox` might generate `ItemEvents` and `FocusEvents`, and a single instance of the `JFrame` class might respond to `ActionEvents` generated by a `JButton` and `ItemEvents` generated by a `JCheckBox`.

The class of the object that responds to an event must contain a method that accepts the event object created by the user's action. A method that executes because it is called automatically when an appropriate event occurs is an **event handler**. In other words, when you register a component (such as a `JFrame`) to be a listener for events generated by another component (such as a `JCheckBox`), you must write an event handler method. You cannot choose your own name for event handlers—specific method identifiers react to specific event types. Table 14-4 lists just some of the methods that react to events.

Listener	Method
<code>ActionListener</code>	<code>actionPerformed(ActionEvent)</code>
<code>AdjustmentListener</code>	<code>adjustmentValueChanged(AdjustmentEvent)</code>
<code>FocusListener</code>	<code>focusGained(FocusEvent)</code> and <code>focusLost(FocusEvent)</code>
<code>ItemListener</code>	<code>itemStateChanged(ItemEvent)</code>

**Table 14-4** Selected methods that respond to events



Each listener in Table 14-4 is associated with only one or two methods. Other listeners, such as `KeyListener` and `MouseListener`, are associated with multiple methods. You will learn how to use these more complicated listeners in the chapter *Advanced GUI Topics*.

Until you become familiar with the event-handling model, it can seem quite confusing. For now, remember these tasks you must perform when you declare a class that handles an event:

- The class that handles an event must either implement a listener interface or extend a class that implements a listener interface. For example, if a `JFrame` named `MyFrame` needs to respond to a user's clicks on a `JCheckBox`, you would write the following class header:

```
public class MyFrame extends JFrame
    implements ItemListener
```

If you then declare a class that extends `MyFrame`, you need not include `implements ItemListener` in its header. The new class inherits the implementation.

- You must register each instance of the event-handling class as a listener for one or more components. For example, if `MyFrame` contains a `JCheckBox` named `myCheckBox`, then within the `MyFrame` class you would code:

```
myCheckBox.addItemListener(this);
```

The `this` reference is to the class in which `myCheckBox` is declared—in this case, `MyFrame`.



You must write an event handler method with an appropriate identifier; the method accepts the generated event and reacts to it.



Watch the video *Event-driven Programming*.

## TWO TRUTHS & A LIE

### Understanding Swing Event Listeners

1. A class can implement as many event listeners as it needs.
2. Any object can be notified of a mouse click or keyboard press as long as it implements the appropriate interface and is registered as an event listener on the appropriate event source.
3. Every event-handling method accepts a parameter that represents the listener for the event.

The false statement is #3. Every event-handling method accepts a parameter that represents the generated event.

## Using the JCheckBox, ButtonGroup, and JComboBox Classes

Besides JButtons and JTextFields, several other Java components allow a user to make selections in a UI environment. These include JCheckBoxes, ButtonGroups, and JComboBoxes.

### The JCheckBox Class

A **JCheckBox** consists of a label positioned beside a square; you can click the square to display or remove a check mark. Usually, you use a JCheckBox to allow the user to turn an option on or off. For example, Figure 14-30 shows the code for an application that uses four JCheckBoxes, and Figure 14-31 shows the output.

```
import java.awt.*;
import javax.swing.*;
import java.awt.event.*;
public class CheckBoxDemonstration
    extends JFrame implements ItemListener
{
    FlowLayout flow = new FlowLayout();
    JLabel label = new JLabel("What would you like to drink?");
    JCheckBox coffee = new JCheckBox("Coffee", false);
    JCheckBox cola = new JCheckBox("Cola", false);
    JCheckBox milk = new JCheckBox("Milk", false);
    JCheckBox water = new JCheckBox("Water", false);
    String output, insChosen;
    public CheckBoxDemonstration()
    {
        super("CheckBox Demonstration");
        setDefaultCloseOperation(JFrame.EXIT_ON_CLOSE);
        setLayout(new FlowLayout());
        label.setFont(new Font("Arial", Font.ITALIC, 22));
        coffee.addItemListener(this);
        cola.addItemListener(this);
        milk.addItemListener(this);
        water.addItemListener(this);
        add(label);
        add(coffee);
        add(cola);
        add(milk);
        add(water);
    }
    public void itemStateChanged(ItemEvent check)
    {
        // Actions based on choice go here
    }
    public static void main(String[] arguments)
    {
        final int FRAME_WIDTH = 350;
        final int FRAME_HEIGHT = 120;
        CheckBoxDemonstration frame =
            new CheckBoxDemonstration();
        frame.setSize(FRAME_WIDTH, FRAME_HEIGHT);
        frame.setVisible(true);
    }
}
```

**Figure 14-30** The `CheckBoxDemonstration` class

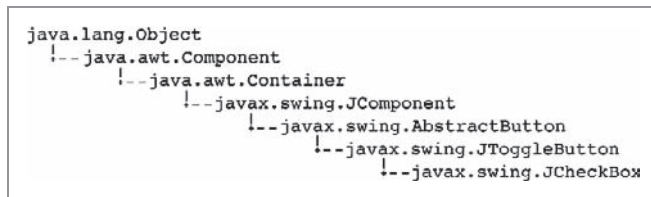


In the application in Figure 14-30, the `CheckBoxDemonstration` class and the `main()` method that instantiates an instance of it are part of the same class. You could also store the two parts in separate classes, as in previous examples.



**Figure 14-31** Output of the `CheckBoxDemonstration` class

The inheritance hierarchy of the `JCheckBox` class is shown in Figure 14-32; frequently used `JCheckBox` methods appear in Table 14-5.



**Figure 14-32** The inheritance hierarchy of the `JCheckBox` class

Method	Purpose
<code>void setText(String)</code>	Sets the text for the <code>JCheckBox</code>
<code>String getText()</code>	Returns the <code>JCheckBox</code> text
<code>void setSelected(boolean)</code>	Sets the state of the <code>JCheckBox</code> to <code>true</code> for selected or <code>false</code> for unselected
<code>boolean isSelected()</code>	Gets the current state (checked or unchecked) of the <code>JCheckBox</code>

**Table 14-5** Frequently used `JCheckBox` methods

Several constructors can be used with `JCheckBox`s. When you construct a `JCheckBox`, you can choose whether to assign it a label; you can also decide whether the `JCheckBox` appears selected (`JCheckBox`s start unselected by default). The following statements create four `JCheckBox` objects—one with no label and unselected, two with labels and unselected, and one with a label and selected.

- `JCheckBox box1 = new JCheckBox();`  
// No label, unselected
- `JCheckBox box2 = new JCheckBox("Check here");`  
// Label, unselected

- `JCheckBox box3 = new JCheckBox("Check here", false);`  
    `// Label, unselected`
- `JCheckBox box4 = new JCheckBox("Check here", true);`  
    `// Label, selected`

If you do not initialize a `JCheckBox` with a label and you want to assign one later, or if you want to change an existing label, you can use the `setText()` method, as in the following example:

```
box1.setText("Check this box now");
```

You can set the state of a `JCheckBox` with the `setSelected()` method; for example, you can use the following statement to ensure that `box1` is unchecked:

```
box1.setSelected(false);
```

The `isSelected()` method is most useful in Boolean expressions, as in the following example, which adds one to a `voteCount` variable if `box2` is currently checked.

```
if(box2.isSelected())  
    ++voteCount;
```

When the status of a `JCheckBox` changes from unchecked to checked (or from checked to unchecked), an `ItemEvent` is generated, and the `itemStateChanged()` method executes. You can use the `getItem()` method to determine which object generated the event and the `getStateChange()` method to determine whether the event was a selection or a deselection. The `getStateChange()` method returns an integer that is equal to one of two class variables—`ItemEvent.SELECTED` or `ItemEvent.DESELECTED`. For example, in Figure 14-33 the `itemStateChanged()` method calls the `getItem()` method, which returns the object named `source`. Then, the value of `source` is tested in an `if` statement to determine if it is equivalent to a `JCheckBox` object named `checkBox`. If the two references are to the same object, the code determines whether the `checkBox` was selected or deselected, and in each case appropriate actions are taken.

```
public void itemStateChanged(ItemEvent e)  
{  
    Object source = e.getItem();  
    if(source == checkBox)  
    {  
        int select = e.getStateChange();  
        if(select == ItemEvent.SELECTED)  
            // statements that execute when the box is checked  
        else  
            // statements that execute when the box is unchecked  
        }  
    else  
    {  
        // statements that execute when the source of the event is  
        // some component other than the checkBox object  
    }  
}
```

**Figure 14-33** Using the `itemStateChanged()` method

## The ButtonGroup Class

Sometimes, you want options to be mutually exclusive—that is, you want the user to be able to select only one of several choices. When you create a **ButtonGroup**, you can group several components, such as

JCheckBoxes, so a user can select only one at a time. When you group JCheckBox objects, all of the other JCheckBoxes are automatically turned off when the user selects any one check box. The inheritance hierarchy for the **ButtonGroup** class is shown in Figure 14-34. You can see that **ButtonGroup** descends directly from the **Object** class. Even though it does not begin with a *J*, the **ButtonGroup** class is part of the `javax.swing` package.

```
java.lang.Object
|-- javax.swing.ButtonGroup
```

**Figure 14-34** The inheritance hierarchy for the **ButtonGroup** class



A group of JCheckBoxes in which a user can select only one at a time also acts like a set of radio buttons (for example, those used to select preset radio stations on an automobile radio), which you can create using the **JRadioButton** class. The **JRadioButton** class is very similar to the **JCheckBox** class, and you might prefer to use it when you have a list of mutually exclusive user options. It makes sense to use **ButtonGroups** with items that can be selected (that is, those that use an `isSelected()` method). You can find more information about the **JRadioButton** class at <http://java.sun.com>.

To create a **ButtonGroup** in a **JFrame** and then add a **JCheckBox**, you must perform four steps:

- Create a **ButtonGroup**, such as `ButtonGroup aGroup = new ButtonGroup();`
- Create a **JCheckBox**, such as `JCheckBox aBox = new JCheckBox();`
- Add `aBox` to `aGroup` with `aGroup.add(aBox);`
- Add `aBox` to the **JFrame** with `add(aBox);`

You can create a **ButtonGroup** and then create the individual **JCheckBox** objects, or you can create the **JCheckBoxes** and then create the **ButtonGroup**. If you create a **ButtonGroup** but forget to add any **JCheckBox** objects to it, then the **JCheckBoxes** act as individual, nonexclusive check boxes.

A user can set one of the **JCheckBoxes** within a group to “on” by clicking it with the mouse, or the programmer can select a **JCheckBox** within a **ButtonGroup** with a statement such as the following:

```
aGroup.setSelected(aBox);
```

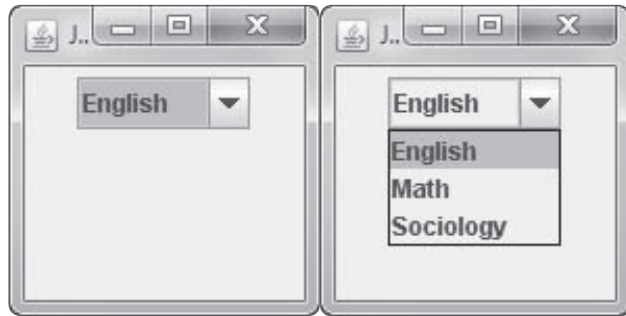
Only one **JCheckBox** can be selected within a group. If you assign the `selected` state to a **JCheckBox** within a group, any previous assignment is negated.

You can determine which, if any, of the **JCheckBoxes** in a **ButtonGroup** is selected using the `isSelected()` method.

After a **JCheckBox** in a **ButtonGroup** has been selected, one in the group will always be selected. In other words, you cannot “clear the slate” for all the items that are members of a **ButtonGroup**. You could cause all the **JCheckBoxes** in a **ButtonGroup** to initially *appear* unselected by adding one **JCheckBox** that is not visible (using the `setVisible()` method). Then, you could use the `setSelected()` method to select the invisible **JCheckBox**, and all the others would appear to be deselected.

## The JComboBox Class

A **JComboBox** is a component that combines two features: a display area showing a default option and a list box that contains additional, alternate options. (A list box is also known as a combo box or a drop-down list.) The display area contains either a button that a user can click or an editable field into which the user can type. When a JComboBox appears on the screen, the default option is displayed. When the user clicks the JComboBox, a list of alternative items drops down; if the user selects one, it replaces the box's displayed item. Figure 14-35 shows a JComboBox as it looks when first displayed and as it looks after a user clicks it. The inheritance hierarchy of the JComboBox class is shown in Figure 14-36.



**Figure 14-35** A JComboBox before and after the user clicks it

```

java.lang.Object
  |-- java.awt.Component
      |-- java.awt.Container
          |-- javax.swing.JComponent
              |-- javax.swing.JComboBox
  
```

**Figure 14-36** The inheritance hierarchy of the JComboBox class



The code that produces the JComboBox in Figure 14-35 is contained in the file named `ComboBoxDemonstration.java` in your downloadable student files.

You can build a JComboBox by using a constructor with no arguments and then adding items (for example, `Strings`) to the list with the `addItem()` method. The following statements create a JComboBox named `majorChoice` that contains three options from which a user can choose:

```

JComboBox majorChoice = new JComboBox();
majorChoice.addItem("English");
majorChoice.addItem("Math");
majorChoice.addItem("Sociology");
  
```

Alternatively, you can construct a JComboBox using an array of `Objects` as the constructor argument; the `Objects` in the array become the listed items within the JComboBox. For example, the following code creates the same `majorChoice` JComboBox as the preceding code:

```

String[] majorArray = {"English", "Math", "Sociology"};
JComboBox majorChoice = new JComboBox(majorArray);
  
```



Users often expect to view JComboBox options in alphabetical order. If it makes sense for your application, consider displaying your options this way. Another reasonable approach is to place the most frequently selected options first.

Table 14-6 lists some methods you can use with a `JComboBox` object. For example, you can use the `setSelectedItem()` or `setSelectedIndex()` method to choose one of the items in a `JComboBox` to be the initially selected item. You also can use the `getSelectedItem()` or `getSelectedIndex()` method to discover which item is currently selected.

Method	Purpose
<code>void addItem(Object)</code>	Adds an item to the list
<code>void removeItem(Object)</code>	Removes an item from the list
<code>void removeAllItems()</code>	Removes all items from the list
<code>Object getItemAt(int)</code>	Returns the list item at the index position specified by the integer argument
<code>int getItemCount()</code>	Returns the number of items in the list
<code>int getMaximumRowCount()</code>	Returns the maximum number of items the combo box can display without a scroll bar
<code>int getSelectedIndex()</code>	Returns the position of the currently selected item
<code>Object selectedItem()</code>	Returns the currently selected item
<code>Object[] getSelectedObjects()</code>	Returns an array containing selected Objects
<code>void setEditable(boolean)</code>	Sets the field to be editable or not editable
<code>void setMaximumRowCount(int)</code>	Sets the number of rows in the combo box that can be displayed at one time
<code>void setSelectedIndex(int)</code>	Sets the index at the position indicated by the argument
<code>void setSelectedItem(Object)</code>	Sets the selected item in the combo box display area to be the Object argument

**Table 14-6** Some `JComboBox` class methods

You can treat the list of items in a `JComboBox` object as an array; the first item is at position 0, the second is at position 1, and so on. It is convenient to use the `getSelectedIndex()` method to determine the list position of the currently selected item; then you can use the index to access corresponding information stored in a parallel array. For example, if a `JComboBox` named `historyChoice` has been filled with a list of historical events, such as “Declaration of Independence,” “Pearl Harbor,” and “Man walks on moon,” you can code the following to retrieve the user’s choice:

```
int positionOfSelection = historyChoice.getSelectedIndex();
```

The variable `positionOfSelection` now holds the position of the selected item, and you can use the variable to access an array of dates so you can display the date that corresponds to the selected historical event. For example, if you declare the following, then `dates[positionOfSelection]` holds the year for the selected historical event:

```
int[] dates = {1776, 1941, 1969};
```





A `JComboBox` does not have to hold items declared as `Strings`; it can hold an array of `Objects` and display the results of the `toString()` method used with those objects. In other words, instead of using parallel arrays to store historical events and dates, you could design a `HistoricalEvent` class that encapsulates `Strings` for the event and `ints` for the date.

In addition to `JComboBoxes` for which users click items presented in a list, you can create `JComboBoxes` into which users type text. To do this, you use the `setEditable()` method. A drawback to using an editable `JComboBox` is that the text a user types must exactly match an item in the list box. If the user misspells the selection or uses the wrong case, no valid value is returned from the `getSelectedIndex()` method. You can use an `if` statement to test the value returned from `getSelectedIndex()`; if it is negative, the selection did not match any items in the `JComboBox`, and you can issue an appropriate error message.

## TWO TRUTHS & A LIE

### Using the `JCheckBox`, `ButtonGroup`, and `JComboBox` Classes

1. A `JCheckBox` consists of a label positioned beside a square; you can click the square to display or remove a check mark.
2. When you create a `ButtonGroup`, you can group several components, such as `JCheckBoxes`, so a user can select multiple options simultaneously.
3. When a user clicks a `JComboBox`, a list of alternative items drops down; if the user selects one, it replaces the box's displayed item.

The false statement is #2. When you create a `ButtonGroup`, you can group several components, such as `JCheckBoxes`, so a user can select only one at a time.

## You Do It

### Creating a `JFrame`

In this section, you will create a `JFrame` object that appears on the screen.

#### To create a `JFrame` object:

1. Open a new file in your text editor.
2. Type the following statement to import the `javax.swing` classes:

```
import javax.swing.*;
```

3. On the next lines, type the following class header for the `JDemoFrame` class and its opening curly brace:

```
public class JDemoFrame
{
```

4. On the next lines, type the following `main()` method header and its opening curly brace:

```
public static void main(String[] args)
{
```

5. Within the body of the `main()` method, enter the following code to declare a `JFrame` with a title, set its size, and make it visible. If you neglect to set a `JFrame`'s size, you see only the title bar of the `JFrame` (because the size is  $0 \times 0$  by default); if you neglect to make the `JFrame` visible, you do not see anything. Add two closing curly braces—one for the `main()` method and one for the `JDemoFrame` class.

```
    JFrame aFrame = new JFrame("This is a frame");
    final int WIDTH = 250;
    final int HEIGHT = 250;
    aFrame.setSize(WIDTH, HEIGHT);
    aFrame.setVisible(true);
}
}
```

6. Save the file as **JDemoFrame.java**. Compile and then run the program. The output looks like Figure 14-37—an empty `JFrame` with a title bar, a little taller than it is wide. The `JFrame` has all the properties of frames you have seen in applications you have used. For example, click the `JFrame`'s **Minimize** button, and the `JFrame` minimizes to an icon on the Windows taskbar.
7. Click the `JFrame`'s **icon** on the taskbar. The `JFrame` returns to its previous size.
8. Click the `JFrame`'s **Maximize** button. The `JFrame` fills the screen.
9. Click the `JFrame`'s **Restore** button. The `JFrame` returns to its original size.
10. Position your mouse pointer on the `JFrame`'s title bar, and then drag the `JFrame` to a new position on your screen.
11. Click the `JFrame`'s **Close** button. The `JFrame` disappears or hides. The default behavior of a `JFrame` is simply to hide when the user clicks the Close button—not to end the program.
12. To end the program and return control to the command line, click the Command Prompt window and then press **Ctrl+C**. In Chapter 6, you learned to press **Ctrl+C** to stop a program that contains an infinite loop. This situation is similar—you want to stop a program that does not have a way to end automatically.



**Figure 14-37** Output of the `JDemoFrame` application

## Ending an Application When a JFrame Closes

Next, you will modify the `JDemoFrame` program so that the application ends when the user clicks the `JDemoFrame` Close button.

### To modify the application so it ends when the user clicks the `JDemoFrame` Close button:

681

1. Within the `JDemoFrame` class file, change the class name to `JDemoFrameThatCloses`.
2. Add a new line of code as the final executable statement within the `main()` method, as follows:
 

```
aFrame.setDefaultCloseOperation(JFrame.EXIT_ON_CLOSE);
```
3. Save the file as `JDemoFrameThatCloses.java`, and compile and execute the application.
4. When the `JFrame` appears on your screen, confirm that it still has Minimize, Maximize, and Restore capabilities. Then click the `JFrame`'s **Close** button. The `JFrame` closes, and the command prompt returns as the program relinquishes control to the operating system.

## Adding Components to a JFrame

Next, you will create a Swing application that displays a `JFrame` that holds a `JLabel`, `JTextField`, and `JButton`.

### To create a `JFrame` that displays three components:

1. Open a new file in your text editor, then type the following first few lines of an application. The import statements make the `Swing` and `AWT` components available, and the class header indicates that the class is a `JFrame`. The class contains several components: a label, field, and button.
 

```
import javax.swing.*;
import java.awt.*;
public class JFrameWithComponents extends JFrame
{
    JLabel label = new JLabel("Enter your name");
    JTextField field = new JTextField(12);
    JButton button = new JButton("OK");
```
2. In the `JFrameWithComponents` constructor, set the `JFrame` title to "Frame with Components" and the default close operation to exit the program when the `JFrame` is closed. Set the layout manager. Add the label, field, and button to the `JFrame`.

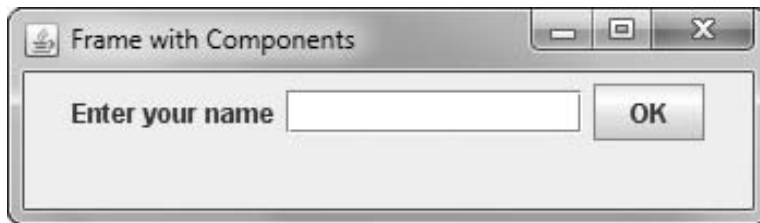
```
public JFrameWithComponents()
{
    super("Frame with Components");
    setDefaultCloseOperation(JFrame.EXIT_ON_CLOSE);
    setLayout(new FlowLayout());
    add(label);
```

```
        add(field);
        add(button);
    }
```

3. Add a closing curly brace for the class, and then save the file as **JFrameWithComponents.java**.
4. Compile the class and correct any errors.
5. Next, write an application that creates a new `JFrameWithComponents` named `aFrame`, sizes it using the `setSize()` method, and then sets its visible property to `true`.

```
import javax.swing.*;
public class CreateJFrameWithComponents
{
    public static void main(String[] args)
    {
        JFrameWithComponents aFrame =
            new JFrameWithComponents();
        final int WIDTH = 350;
        final int HEIGHT = 100;
        aFrame.setSize(WIDTH, HEIGHT);
        aFrame.setVisible(true);
    }
}
```

6. Save the file as **CreateJFrameWithComponents.java**. Compile and then execute the application. The output is shown in Figure 14-38.



**Figure 14-38** Output of the `CreateJFrameWithComponents` application

7. Click the `JButton`. It acts like a button should—that is, it appears to be pressed when you click it, but nothing happens because you have not yet written instructions for the button clicks to execute.
8. Close the application.

## Adding Functionality to a `JButton` and a `JTextField`

Next, you will add functionality to the `JButton` and `JTextField` that you created in the `JFrameWithComponents` class.

### To create an application with a functional JButton:

1. Open the **JFrameWithComponents.java** file. Immediately save the file as **JAction.java**.
2. After the existing import statements at the top of the file, add the following import statement that will allow event handling:
 

```
import java.awt.event.*;
```
3. Change the class name to **JAction** to match the new filename. Also change the constructor header to match the new class name. Within the constructor, change the string argument to the `super()` method from “Frame with Components” to “Action”.
4. After `extends JFrame` at the end of the **JAction** class header, add the following phrase so that the class can respond to `ActionEvents`:
 

```
implements ActionListener
```
5. Register the **JAction** class as a listener for events generated by either the button or the text field by adding the following statements at the end of, but within, the `JAction()` constructor:
 

```
button.addActionListener(this);
field.addActionListener(this);
```
6. Just prior to the closing curly brace for the class, add the following `actionPerformed()` method. The method changes the text on both the label and the button whenever the user clicks the button or presses Enter in the text field.
 

```
public void actionPerformed(ActionEvent e)
{
    label.setText("Thank you");
    button.setText("Done");
}
```
7. Just after the `actionPerformed()` method, and just before the closing curly brace for the class, add a `main()` method to the class so that you can instantiate a **JAction** object for demonstration purposes.
 

```
public static void main(String[] args)
{
    JAction aFrame = new JAction();
    final int WIDTH = 250;
    final int HEIGHT = 100;
    aFrame.setSize(WIDTH, HEIGHT);
    aFrame.setVisible(true);
}
```
8. Save the file, then compile and execute it. The output looks like the frame on the left side of Figure 14-39. Type a name in the text field and then click the **OK** button. Its text changes to “Done”, and its size increases slightly because the label “Done” requires more space than the label “OK”. The other label requires less space than it did because “Thank you” is a shorter message than “Enter your name”. Therefore, all the components are redistributed because the `FlowLayout` manager places as many

components as will fit horizontally in the top row before adding components to subsequent rows. The output looks like the right side of Figure 14-39.



**Figure 14-39** Output of the `JAction` application after the user clicks the OK button

9. Close the application and then execute it again. This time, enter a name in the text field and press **Enter**. Again, the button text changes, showing that the `actionPerformed()` method reacts to actions that take place on either the button or the text field.
10. Close the application.

## Distinguishing Event Sources

Next, you will modify the `actionPerformed()` method of the `JAction` class so that different results occur depending on which action a user takes.

### To take different actions depending on the source of an event:

1. Open the `JAction.java` file in your text editor if the file is not still open. Immediately save the file as `JAction2.java`.
2. Change the class name and the constructor name to match the new filename by adding **2** to each name.
3. In the `main()` method, change the statement that instantiates the `JFrame` object to the following:

```
JAction2 aFrame = new JAction2();
```

4. Within the `actionPerformed()` method, you can use the named `ActionEvent` argument and the `getSource()` method to determine the source of the event. Using an `if` statement, you can take different actions when the argument represents different sources. For example, you can change the label in the frame to indicate the event's source. Change the `actionPerformed()` method to:

```
public void actionPerformed(ActionEvent e)
{
    Object source = e.getSource();
    if(source == button)
        label.setText("You clicked the button");
    else
        label.setText("You pressed Enter");
}
```

- Save the file (as `JAction2.java`), then compile and execute it. Type a name, press **Enter** or click the button, and notice the varying results in the frame's label. For example, Figure 14-40 shows the application after the user has typed a name and pressed Enter.
- Close the application.



**Figure 14-40** Typical execution of the `JAction2` application

## Including JCheckBoxes in an Application

Next, you will create an interactive program for a resort. The base price for a room is \$200, and a guest can choose from several options. Reserving a room for a weekend night adds \$100 to the price, including breakfast adds \$20, and including a round of golf adds \$75. A guest can select none, some, or all of these premium additions. Each time the user changes the option package, the price is recalculated.

**To write a Swing application that includes three JCheckBox objects used to determine resort costs:**

- Open a new file in your text editor, then type the following first few lines of a Swing application that demonstrates the use of a `JCheckBox`. Note that the `JResortCalculator` class implements the `ItemListener` interface:

```
import javax.swing.*;
import java.awt.*;
import java.awt.event.*;
public class JResortCalculator extends
    JFrame implements ItemListener
{
```

- Declare the named constants that hold the base price for a resort room and the premium amounts for a weekend stay, including breakfast and a round of golf. Also include a variable that holds the total price for the stay, and initialize it to the value of the base price. Later, depending on the user's selections, premium fees might be added to `totalPrice`, making it more than `BASE_PRICE`.

```
final int BASE_PRICE = 200;
final int WEEKEND_PREMIUM = 100;
final int BREAKFAST_PREMIUM = 20;
final int GOLF_PREMIUM = 75;
int totalPrice = BASE_PRICE;
```

- Declare three `JCheckBox` objects. Each is labeled with a `String` that contains a description of the option and the cost of the option. Each `JCheckBox` starts unchecked or deselected.

```
JCheckBox weekendBox = new JCheckBox
("Weekend premium $" + WEEKEND_PREMIUM, false);
```

```
JCheckBox breakfastBox = new
    JCheckBox("Breakfast $" + BREAKFAST_PREMIUM, false);
JCheckBox golfBox = new JCheckBox
    ("Golf $" + GOLF_PREMIUM, false);
```

4. Include JLabels to hold user instructions and information and a JTextField in which to display the total price:

```
JLabel resortLabel = new JLabel
    ("Resort Price Calculator");
JLabel priceLabel = new JLabel("The price for your stay is");
JTextField totalPrice = new JTextField(4);
JLabel optionExplainLabel = new JLabel
    ("Base price for a room is $"
    + BASE_PRICE + ".");
JLabel optionExplainLabel2 = new JLabel
    ("Check the options you want.");
```

5. Begin the JResortCalculator class constructor. Include instructions to set the title by passing it to the JFrame parent class constructor, to set the default close operation, and to set the layout manager. Then add all the necessary components to the JFrame.

```
public JResortCalculator()
{
    super("Resort Price Estimator");
    setDefaultCloseOperation(JFrame.EXIT_ON_CLOSE);
    setLayout(new FlowLayout());
    add(resortLabel);
    add(optionExplainLabel);
    add(optionExplainLabel2);
    add(weekendBox);
    add(breakfastBox);
    add(golfBox);
    add(priceLabel);
    add(totalPrice);
}
```

6. Continue the constructor by setting the text of the totalPrice JTextField to display a dollar sign and the totalPrice value. Register the class as a listener for events generated by each of the three JCheckBoxes. Finally, add a closing curly brace for the constructor.

```
totalPrice.setText("$" + totalPrice);
weekendBox.addItemListener(this);
breakfastBox.addItemListener(this);
golfBox.addItemListener(this);
}
```

7. Begin the itemStateChanged() method that executes when the user selects or deselects a JCheckBox. Use the appropriate methods to determine which JCheckBox is the source of the current ItemEvent and whether the event was generated by selecting a JCheckBox or by deselecting one.

```
public void itemStateChanged(ItemEvent event)
{
    Object source = event.getSource();
    int select = event.getStateChange();
}
```



8. Write a nested `if` statement that tests whether the source is equivalent to the `weekendBox`, `breakfastBox`, or, by default, the `golfBox`. In each case, depending on whether the item was selected or deselected, add or subtract the corresponding premium fee from the `totalPrice`. Display the total price in the `JTextField`, and add a closing curly brace for the method.

```

if(source == weekendBox)
    if(select == ItemEvent.SELECTED)
        totalPrice += WEEKEND_PREMIUM;
    else
        totalPrice -= WEEKEND_PREMIUM;
else if(source == breakfastBox)
{
    if(select == ItemEvent.SELECTED)
        totalPrice += BREAKFAST_PREMIUM;
    else
        totalPrice -= BREAKFAST_PREMIUM;
}
else // if(source == golfBox) by default
    if(select == ItemEvent.SELECTED)
        totalPrice += GOLF_PREMIUM;
    else
        totalPrice -= GOLF_PREMIUM;
    totalPrice.setText("$" + totalPrice);
}

```

9. Add a `main()` method that creates an instance of the `JFrame` and sets its size and visibility. Then add a closing curly brace for the class.

```

public static void main(String[] args)
{
    JResortCalculator aFrame =
        new JResortCalculator();
    final int WIDTH = 300;
    final int HEIGHT = 200;
    aFrame.setSize(WIDTH, HEIGHT);
    aFrame.setVisible(true);
}
}

```

10. Save the file as **JResortCalculator.java**. Compile and execute the application. The output appears in Figure 14-41 with the base price initially set to \$200.
11. Select the **Weekend premium** `JCheckBox`, and note the change in the total price of the event. Experiment with selecting and deselecting options to ensure that the price changes correctly. For example, Figure 14-42 shows the application with the weekend and golf options selected, adding a total of \$175 to the \$200 base price. After testing all the option combinations, close the application.

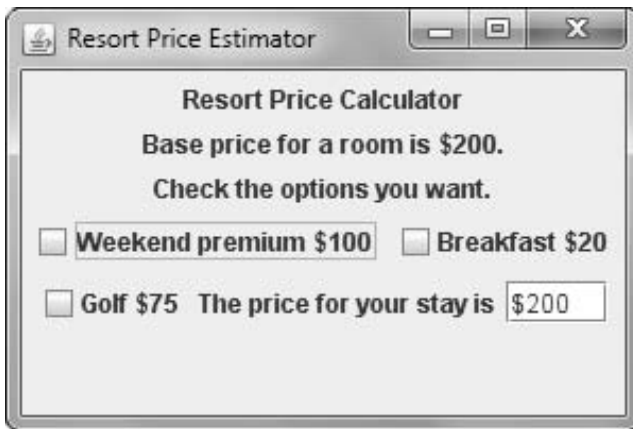


Figure 14-41 Initial output of the `JResortCalculator` application

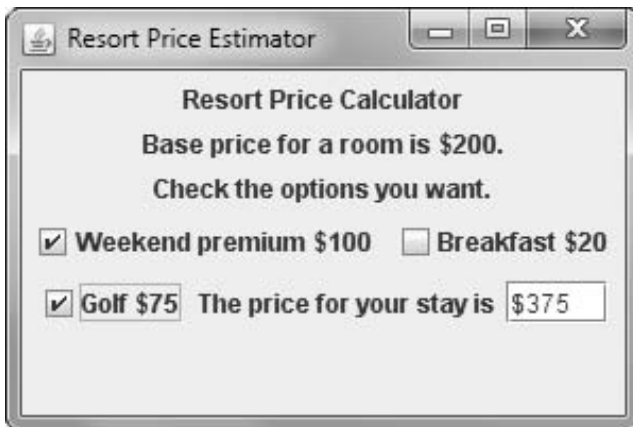


Figure 14-42 Output of the `JResortCalculator` application after the user has made selections

## Don't Do It

- Don't forget the `x` in `javax` when you import Swing components into an application.
- Don't forget to use a `JFrame`'s `setVisible()` method if you want the `JFrame` to be visible.
- Don't forget to use `setLayout()` when you add multiple components to a `JFrame`.
- Don't forget to call `validate()` and `repaint()` after you add or remove a component from a container that has been made visible.
- Don't forget that the `ButtonGroup` class does not begin with a *J*.

## Key Terms

**UI components** are user interface components, such as buttons and text fields, with which the user can interact.

**Swing components** are UI elements such as dialog boxes and buttons; you can usually recognize their names because they begin with *J*.

**Java Foundation Classes**, or **JFC**, include Swing component classes and selected classes from the `java.awt` package.

**Lightweight components** are written completely in Java and do not have to rely on the code written to run the local operating system.

**Heavyweight components** require interaction with the local operating system.

A **container** is a type of component that holds other components so you can treat a group of them as a single entity. Often, a container takes the form of a window that you can drag, resize, minimize, restore, and close.

A **JFrame** is a container with a title bar and border.

**Pixels** are the picture elements, or tiny dots of light, that make up the image on your computer monitor.

**Window decorations** are the icons and buttons that are part of a window or frame.

A **look and feel** is the default appearance and behavior of any user interface.

**JLabel** is a built-in Java Swing class that holds text you can display.

The **add() method** adds components to a container.

The **remove() method** removes components from a container.

The **setText() method** allows you to change the text in a `Component` that has already been created.

The **getText() method** allows you to retrieve the `String` of text in a `Component`.

The **Font class** holds typeface and size information.

The **setFont() method** changes a `JLabel`'s font.

The **typeface argument** to the `Font` constructor is a `String` representing a font. Common fonts have names such as Arial, Century, Monospaced, and Times New Roman.

The **style argument** to the `Font` constructor applies an attribute to displayed text and is one of three values: `Font.PLAIN`, `Font.BOLD`, or `Font.ITALIC`.

The **point size argument** to the `Font` constructor is an integer that represents about 1/72 of an inch.

A **layout manager** is a class that controls component positioning.

A **BorderLayout** is a layout manager that divides a container into regions.

The **flow layout manager** places components in a row, and when a row is filled, components automatically spill into the next row. By default, the components in each row are centered.

A **JTextField** is a component into which a user can type a single line of text data.

**Editable** describes a component that can accept keystrokes.

The **setEditable()** method changes the editable status of a **JTextField**.

A **JButton** is a **Component** the user can click with a mouse to make a selection.

**Tool tips** are popup windows that can help a user understand the purpose of components in an application; a tool tip appears when a user hovers the mouse pointer over the component.

The **setToolTipText()** method defines the text to be displayed in a tool tip.

An **event** occurs when a user takes action on a component.

In an **event-driven program**, the user might initiate any number of events in any order.

The **source** of an event is the component on which an event is generated.

A **listener** is an object that is interested in an event.

You tell a class to expect **ActionEvents** with the **addActionListener()** method.

The **actionPerformed(ActionEvent e)** method specification defines the actions that occur in response to an event.

The **setEnabled()** method makes a component available or dimmed and unavailable.

An **event handler** is a method that executes because it is called automatically when an appropriate event occurs.

A **JCheckBox** consists of a label positioned beside a square; you can click the square to display or remove a check mark. Usually, you use a **JCheckBox** to allow the user to turn an option on or off.

A **ButtonGroup** groups several components, such as **JCheckBoxes**, so a user can select only one at a time.

A **JComboBox** is a component that combines two features: a display area showing a default option and a list box containing additional options. The display area contains either a button that a user can click or an editable field into which the user can type.

## Chapter Summary

- Swing components are UI elements such as dialog boxes and buttons. Each Swing component is a descendant of a `JComponent`, which in turn inherits from the `java.awt.Container` class. When you use Swing components, you usually place them in a container—a type of component that holds other components. Containers are defined in the `Container` class. Often, a container takes the form of a window that you can drag, resize, minimize, restore, and close.
- A `JFrame` holds and displays other objects. Useful methods include `setSize()`, `setTitle()`, `setVisible()`, `setBounds()`, and `setDefaultCloseOperation()`. `JFrames` include a title bar at the top containing text information, and Minimize, Maximize or Restore, and Close buttons in the frame's upper-right corner. When a user closes a `JFrame` by clicking the Close button in the upper-right corner, the default behavior is for the `JFrame` to become hidden and for the application to keep running.
- `JLabel` is a built-in Java Swing class that holds text you can display. You then can add a `JLabel` to a `JFrame` using the `add()` method. The `setFont()` method changes the font typeface, style, and point size.
- To place multiple components at specified positions in a container so they do not hide each other, you must use a layout manager—a class that controls component positioning. The normal (default) behavior of a `JFrame` is to use a layout format named `BorderLayout`. When you use a `FlowLayout` instead of a `BorderLayout`, components do not lie on top of each other. Instead, components are placed in a row, and when a row is filled, components automatically spill into the next row.
- The advantage of creating a child class of `JFrame` is that you can set the `JFrame`'s properties within your object's constructor; then, when you create your `JFrame` child object, it is automatically endowed with the features you have specified, such as title, size, and default close operation.
- A `JTextField` is a component into which a user can type a single line of text data. A `JButton` is a `Component` the user can click with a mouse to make a selection. Tool tips are popup windows that can help a user understand the purpose of components in an application; the tool tip appears when a user hovers the mouse pointer over the component.
- Within an event-driven program, a component on which an event is generated is the source of the event. An object that is interested in an event is a listener. You prepare your class to accept button-press events by importing the `java.awt.event` package into your program and adding the phrase `implements ActionListener` to the class header. You tell your class to expect `ActionEvents` with the `addActionListener()` method. The `ActionListener` interface contains the `actionPerformed(ActionEvent e)` method specification. You implement this method with the actions that should occur in response to the event. Within the `actionPerformed()` method, you can use the `getSource()` method of the object sent to determine which component generated the event.
- A class can implement as many event listeners as it needs. Examples of event listeners are `ActionListener`, `ItemListener`, `KeyListener`, and `MouseListener`. Any object can be notified of an event as long as it implements the appropriate interface and is registered as

an event listener on the appropriate event source. To add a listener method to a source, you must use the appropriate designated `add()` method. Specific methods react to specific event types; they include `actionPerformed()` and `itemStateChanged()`.

- A `JCheckBox` consists of a label positioned beside a square; you can click the square to display or remove a check mark. Usually, you use a `JCheckBox` to allow the user to turn an option on or off. A `ButtonGroup` groups components so a user can select only one at a time. After a `JCheckBox` in a `ButtonGroup` has been selected, one in the group will always be selected. A `JComboBox` is a component that combines two features: a display area showing a default option and a list box containing additional options. You can treat the list of items in a `JComboBox` object as an array and use the `getSelectedIndex()` method to determine the list position of the currently selected item.

## Review Questions

1. A `JFrame` is a descendant of each of the following classes except the \_\_\_\_\_ class.
  - a. `Component`
  - b. `Container`
  - c. `Window`
  - d. `Jar`
2. A programmer might prefer using a `JFrame` instead of a `Window` because, unlike a window, a `JFrame` \_\_\_\_\_.
  - a. can hold other objects
  - b. can be made visible
  - c. can have descendants
  - d. has a title bar and border
3. The statement `JFrame myFrame = new JFrame();` creates a `JFrame` that is \_\_\_\_\_.
  - a. invisible and has no title
  - b. invisible and has a title
  - c. visible and has no title
  - d. visible and has a title
4. To create a `JFrame` named `aFrame` that is 300 pixels wide by 200 pixels tall, you can \_\_\_\_\_.
  - a. use the declaration `JFrame aFrame = new JFrame(300, 200);`
  - b. declare a `JFrame` named `aFrame` and then code `aFrame.setSize(300, 200);`
  - c. declare a `JFrame` named `aFrame` and then code `aFrame.setBounds(300, 200);`
  - d. use any of the above
5. When a user closes a `JFrame`, the default behavior is for \_\_\_\_\_.
  - a. the `JFrame` to close and the application to keep running
  - b. the `JFrame` to become hidden and the application to keep running
  - c. the `JFrame` to close and the application to exit
  - d. nothing to happen

6. An advantage of extending the JFrame class is \_\_\_\_\_.
  - a. you can set the child class properties within the class constructor
  - b. there is no other way to cause an application to close when the user clicks a JFrame's Close button
  - c. there is no other way to make a JFrame visible
  - d. all of the above
7. Suppose you create an application in which you instantiate a JFrame named `frame1` and a JLabel named `label1`. Which of the following statements within the application adds `label1` to `frame1`?
  - a. `label1.add(frame1);`
  - b. `frame1.add(label1);`
  - c. `this.add(label1);`
  - d. two of the above
8. The arguments required by the Font constructor include all of the following except \_\_\_\_\_.
  - a. typeface
  - b. style
  - c. mode
  - d. point size
9. A class that controls component positioning in a JFrame is a \_\_\_\_\_.
  - a. container
  - b. layout manager
  - c. formatter
  - d. design supervisor
10. Which of the following is not true of a JTextField?
  - a. A user can type text data into it.
  - b. Its data can be set in the program instead of by the user.
  - c. You can set its attributes so that a user cannot type in it.
  - d. It is a type of Container.
11. \_\_\_\_\_ are popup windows that can help a user understand the purpose of components in an application and that appear when a user hovers the mouse pointer over the component.
  - a. Navigation notes
  - b. Tool tips
  - c. Help icons
  - d. Graphic suggestions
12. Within an event-driven program, a component on which an event is generated is the \_\_\_\_\_.
  - a. performer
  - b. listener
  - c. source
  - d. handler
13. A class that will respond to button-press events must use which phrase in its header?
  - a. `import java.event`
  - b. `extends Action`
  - c. `extends JFrame`
  - d. `implements ActionListener`

14. A JFrame contains a JButton named `button1` that should execute an `actionPerformed()` method when clicked. Which statement is needed in the JFrame class?
- a. `addActionListener(this);`
  - b. `addActionListener(button1);`
  - c. `button1.addActionListener(this);`
  - d. `this.addActionListener(button1);`
15. An application that must respond to button clicks must implement a(n) \_\_\_\_\_.
- a. `ButtonListener`
  - b. `ItemListener`
  - c. `ClickListener`
  - d. `ActionListener`
16. A class can implement \_\_\_\_\_.
- a. one listener
  - b. two listeners
  - c. as many listeners as it needs
  - d. any number of listeners as long as they are not conflicting listeners
17. When you write a method that reacts to `JCheckBox` changes, you name the method \_\_\_\_\_.
- a. `itemStateChanged()`
  - b. `actionPerformed()`
  - c. `checkBoxChanged()`
  - d. any legal identifier you choose
18. If a class contains two components that might each generate a specific event type, you can determine which component caused the event by using the \_\_\_\_\_ method.
- a. `addActionListener()`
  - b. `getSource()`
  - c. `whichOne()`
  - d. `identifyOrigin()`
19. To group several components such as `JCheckBoxes` so that a user can select only one at a time, you create a \_\_\_\_\_.
- a. `JCheckBoxGroup`
  - b. `CheckBoxGroup`
  - c. `JButtonGroup`
  - d. `ButtonGroup`
20. Suppose you have declared a `ButtonGroup` named `threeOptions` and added three `JCheckBoxes` named `box1`, `box2`, and `box3` to it. If you code `threeOptions.setSelected(box1);`, then `threeOptions.setSelected(box2);`, and then `threeOptions.setSelected(box3);`, which box is selected?
- a. `box1`
  - b. `box2`
  - c. `box3`
  - d. all of the above



## Exercises

1. Write an application that displays a `JFrame` containing the words to any well-known nursery rhyme. Save the file as **`JNurseryRhyme.java`**.
2. a. Write an application that instantiates a `JFrame` that contains a `JButton`. Disable the `JButton` after the user clicks it. Save the file as **`JFrameDisableButton.java`**.  
b. Modify the `JFrameDisableButton` program so that the `JButton` is not disabled until the user has clicked at least eight times. At that point, display a `JLabel` that indicates “That’s enough!”. Save the file as **`JFrameDisableButton2.java`**.
3. Create an application with a `JFrame` that holds five labels describing reasons that a customer might not buy your product (for example, “Too expensive”). Every time the user clicks a `JButton`, remove one of the negative reasons. Save the file as **`JDemoResistance.java`**.
4. Write an application for a construction company to handle a customer’s order to build a new home. Use separate `ButtonGroups` to allow the customer to select one of four models, the number of bedrooms, and a garage type. Assume that the models are the Aspen, \$100,000; the Brittany, \$120,000; the Colonial, \$180,000; or the Dartmoor, \$250,000. Assume that any model can have two, three, or four bedrooms and that each bedroom adds \$10,500 to the base price. Assume that the garage type can be zero-, one-, two-, or three-car, and that each car adds \$7,775 to the price. Save the file as **`JMyNewHome.java`**.
5. a. Write an application for a video store. Place the names of 10 of your favorite movies in a combo box. Let the user select a movie to rent. Display the rental fee, which is \$1.00, \$2.00, or \$3.00 for each movie. Save the file as **`JVideo.java`**.  
b. Change the `JVideo` application to include an editable combo box. Allow the user to type the name of the movie to rent. Display an appropriate error message if the desired movie is not available. Save the file as **`JVideo2.java`**.
6. Design an application for a pizzeria. The user makes pizza order choices from list boxes, and the application displays the price. The user can choose a pizza size of small (\$7), medium (\$9), large (\$11), or extra large (\$14), and one of any number of toppings. There is no additional charge for cheese, but any other topping adds \$1 to the base price. Offer at least five different topping choices. Save the file as **`JPizza.java`**.
7. Write an application that allows a user to select a favorite basketball team from a list box. Include at least five teams in the list, and display the chosen team in a text field after the user makes a selection. Save the file as **`JBasketball.java`**.
8. Write an application that allows the user to choose insurance options in `JCheckBoxes`. Use a `ButtonGroup` to allow the user to select only one of two insurance types—HMO (health maintenance organization) or PPO (preferred provider organization). Use regular (single) `JCheckBoxes` for dental insurance and vision insurance options; the user can select one option, both options, or neither option. As the user selects each option, display its name and price in a text field; the HMO costs \$200 per month, the PPO costs \$600 per

month, the dental coverage adds \$75 per month, and the vision care adds \$20 per month. When a user deselects an item, make the text field blank. Save the file as **JInsurance.java**.

9.
  - a. Search the Java Web site at <http://java.sun.com> for information on how to use a `JTextArea`, its constructors, and its `setText()` and `append()` methods. Write an application that allows the user to select options for a dormitory room. Use `JCheckBoxes` for options such as private room, Internet connection, cable TV connection, microwave, refrigerator, and so on. When the application starts, use a text area to display a message listing the options that are not yet selected. As the user selects and deselects options, add appropriate messages to the common text area so it accumulates a running list that reflects the user's choices. Save the file as **JDorm.java**.
  - b. Modify the `JDorm` application so that instead of a running list of the user's choices, the application displays only the current choices. Save the file as **JDorm2.java**.
10. Create an application for Koch's Cottages, a weekend getaway resort that rents cottages and boats to use on the local lake. The application allows users to compute the price of their vacations. Include mutually exclusive check boxes to select a one-bedroom cottage at \$600 per week or a two-bedroom cottage at \$850 per week. The user also can choose a rowboat rental at \$60 per week. Include labels as appropriate to explain the application's functionality. Save the file as **JCottageFrame.java**.



### Debugging Exercise

11. Each of the following files in the Chapter.14 folder of your downloadable student files has syntax and/or logic errors. In each case, determine the problem and fix the program. After you correct the errors, save each file using the same filename preceded with `Fix`. For example, `DebugFourteen1.java` will become `FixDebugFourteen1.java`.
  - a. `DebugFourteen1.java`
  - b. `DebugFourteen2.java`
  - c. `DebugFourteen3.java`
  - d. `DebugFourteen4.java`



### Game Zone

12.
  - a. Create a quiz game that displays, in turn, five questions about any topic of your choice. All five questions should have the same three possible multiple-choice answers. For example, you might ask trivia questions about U.S. states for which the correct response is either California, Florida, or New York. After each question is displayed, allow the user to choose one, two, or all three answers by selecting `JCheckBoxes`. In other words, if the user is sure of an answer, he will select just one box, but if he is uncertain, he might select two or three boxes. When the user is ready to submit the answer(s), he clicks a button. If the user's answer to the question is correct and he has selected just one box, award 5 points. If the user is correct but

has selected two boxes, award 2 points. If the user has selected all three boxes, award 1 point. If the user has selected fewer than three boxes but is incorrect, the user receives 0 points. A total of 25 points is possible. If the user has accumulated more than 21 points at the end of the quiz, display the message “Fantastic!”. If the user has accumulated more than 15 points, display the message “Very good”, and if the user has accumulated fewer points, display “OK”. Save the file as **HedgeYourBet.java**.

- b. Modify the **HedgeYourBet** game so that it stores the player’s score from the last game in a file and displays the previous score at the start of each new game. (The first time you play the game, the previous score should be 0.) Save the game as **HedgeYourBetUsingFile.java**.
13. In Chapter 5, you created a lottery game application. Create a similar game using check boxes. For this game, generate six random numbers, each between 0 and 30 inclusive. Allow the user to choose six check boxes to play the game. (Do not allow the user to choose more than six boxes.) After the player has chosen six numbers, display the randomly selected numbers, the player’s numbers, and the amount of money the user has won, as follows:

<b>Matching Numbers</b>	<b>Award (\$)</b>
Three matches	100
Four matches	10,000
Five matches	50,000
Six matches	1,000,000
Zero, one, or two matches	0

Save the file as **JLottery2.java**.

14. a. Create a game called Last Man Standing in which the objective is to select the last remaining **JCheckBox**. The game contains 10 **JCheckBox**s. The player can choose one, two, or three boxes, and then click a  **JButton** to indicate the turn is complete. The computer then randomly selects one, two, or three **JCheckBox** objects. When the last **JCheckBox** is selected, display a message indicating the winner. Save the game as **LastManStanding.java**.
- b. In the current version of the Last Man Standing game, the computer might seem to make strategic mistakes because of its random selections. For example, when only two **JCheckBox** objects are left, the computer might randomly choose to check only one, allowing the player to check the last one and win. Modify the game to make it as smart as possible, using a random value for the number of the computer’s selections only when there is no superior alternative. Save the improved game as **SmarterLastManStanding.java**.

*This page intentionally left blank*

# Advanced GUI Topics

In this chapter, you will:

- ① Use content panes
- ① Use color
- ① Learn more about layout managers
- ① Use `JPanels` to increase layout options
- ① Create `JScrollPane`s
- ① Understand events and event handling more thoroughly
- ① Use the `AWTEvent` class methods
- ① Handle mouse events
- ① Use menus

## Understanding the Content Pane

The `JFrame` class is a **top-level container** Swing class. (The other two top-level container classes are `JDialog` and `JApplet`.) Every GUI component that appears on the screen must be part of a containment hierarchy. A **containment hierarchy** is a tree of components that has a top-level container as its root (that is, at its uppermost level). Every top-level container has a **content pane** that contains all the visible components in the container's user interface. The content pane can contain components like `JButtons` directly, or it can hold other containers, like `JPanels`, that in turn contain such components.

A top-level container can contain a menu bar. Conventionally, a **menu bar** is a horizontal strip that is placed at the top of a container and that contains user options. The menu bar, if there is one, is just above (and separate from) the content pane. A **glass pane** resides above the content pane. Figure 15-1 shows the relationship between a `JFrame` and its root, content, and glass panes.

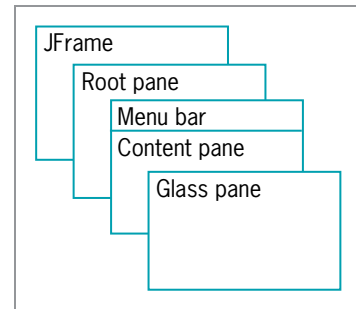


Figure 15-1 Parts of a `JFrame`



The glass pane is a powerful container feature. Tool tips, which you learned about in Chapter 14, reside on the glass pane. You also can draw your own graphics on the glass pane “on top of” components on a `JFrame` or `JApplet`. (You will learn about drawing in the *Graphics* chapter, and about `JApplets` in the chapter *Applets, Images, and Sound*.) If you add a `MouseListener` to the glass pane, it prevents the mouse from triggering events on the components below the glass pane on the `JFrame`.



An additional layered pane exists above the root pane, but it is not often used explicitly by Java programmers. For more details, see <http://java.sun.com>.

Whenever you create a `JFrame` (or other top-level container), you can get a reference to its content pane using the **`getContentPane()` method**. In Chapter 14, you added and removed components from `JFrames` and set their layout managers without understanding you were using the content pane. You had this ability because Java automatically converts `add()`, `remove()`, and `setLayoutManager()` statements to more complete versions. For example, the following three statements are equivalent within a class that descends from `JFrame`:

```
this.getContentPane().add(aButton);
getContentPane().add(aButton);
add(aButton);
```

In the first statement, `this` refers to the `JFrame` class in which the statement appears, and `getContentPane()` provides a reference to the content pane. In the second statement, the `this` reference is implied. In the third statement, both the `this` reference and the `getContentPane()` call are implied.

Although you do not need to worry about the content pane if you only add components to, remove components from, or set the layout manager of a `JFrame`, you must refer to the content pane for all other actions, such as setting the background color.

When you write an application that adds multiple components to a content pane, it is more efficient to declare an object that represents the content pane than to keep calling the `getContentPane()` method. For example, consider the following code in a `JFrame` class that adds three buttons:

```
getContentPane().add(button1);
getContentPane().add(button2);
getContentPane().add(button3);
```

You might prefer to write the following statements. The call to `getContentPane()` is made once, its reference is stored in a variable, and the reference name is used repeatedly with the call to the `add()` method:

```
Container con = getContentPane();
con.add(button1);
con.add(button2);
con.add(button3);
```

As an example, the class in Figure 15-2 creates a `JFrame` like the ones you created throughout Chapter 14, although to keep the example simple, the default close operation was not set and the button was not assigned any tasks.

```
import java.awt.*;
import javax.swing.*;
public class JFrameWithExplicitContentPane extends JFrame
{
    private final int SIZE = 180;
    private Container con = getContentPane();
    private JButton button = new JButton("Press Me");
    public JFrameWithExplicitContentPane()
    {
        super("Frame");
        setSize(SIZE, SIZE);
        con.setLayout(new FlowLayout());
        con.add(button);
    }
    public static void main(String[] args)
    {
        JFrameWithExplicitContentPane frame =
            new JFrameWithExplicitContentPane();
        frame.setVisible(true);
    }
}
```

**Figure 15-2** The `JFrameWithExplicitContentPane` class

In Figure 15-2, the `getContentPane()` method assigns a reference to a `Container` named `con`, and the `Container` reference is used later with the `setLayout()` and `add()` methods. Figure 15-3 shows the result. The frame constructed from the class in Figure 15-2 is identical to the one that would be constructed if the shaded parts were omitted.

When you want to use methods other than `add()`, `remove()`, or `setLayout()`, you must use a content pane. In the next sections you will learn about methods such as `setBackground()`, which is used to change a `JFrame`'s background color, and `setLayout()`, which is used to change a `JFrame`'s layout manager. If you use these methods with a `JFrame` instead of its content pane, the user will not see the results.



**Figure 15-3** Output of the `JFrameWithExplicitContentPane` application

## TWO TRUTHS & A LIE

### Understanding the Content Pane

1. Every Java component has a content pane that contains all the visible parts a user sees.
2. Whenever you create a `JFrame`, you can get a reference to its content pane using the `getContentPane()` method.
3. When you change the background color or layout of a `JFrame`, you should change the content pane and not the `JFrame` directly.

The false statement is #1. Every top-level container has a content pane that contains all the visible components in the container's user interface.

## Using Color

The `Color` class defines colors for you to use in your applications. The `Color` class can be used with the `setBackground()` and `setForeground()` methods of the `Component` class to make your applications more attractive and interesting. When you use the `Color` class, you include the statement `import java.awt.Color;` at the top of your class file.





The statement `import java.awt.*` uses the wildcard to import all of the types in the `java.awt` package, but it does not import `java.awt.Color`, `java.awt.Font`, or any other packages within `awt`. If you plan to use the classes from `java.awt` and from `java.awt.Color`, you must use both `import` statements.

The `Color` class defines named constants that represent 13 colors, as shown in Table 15-1. Java constants are usually written in all uppercase letters, as you learned in Chapter 2. However, Java's creators declared two constants for every color in the `Color` class—an uppercase version, such as `BLUE`, and a lowercase version, such as `blue`. Earlier versions of Java contained only the lowercase `Color` constants. (The uppercase `Color` constants use an underscore in `DARK_GRAY` and `LIGHT_GRAY`; the lowercase versions are a single word: `darkgray` and `lightgray`.)

BLACK	GREEN	RED
BLUE	LIGHT_GRAY	WHITE
CYAN	MAGENTA	YELLOW
DARK_GRAY	ORANGE	
GRAY	PINK	

**Table 15-1** `Color` class constants

You can also create your own `Color` object with the following statement:

```
Color someColor = new Color(r, g, b);
```

In this statement, `r`, `g`, and `b` are numbers representing the intensities of red, green, and blue you want in your color. The numbers can range from 0 to 255. For example, the color black is created using `r`, `g`, and `b` values 0, 0, 0, and white is created by 255, 255, 255. The following statement produces a dark purple color that has red and blue components, but no green.

```
Color darkPurple = new Color(100, 0, 100);
```

You can create more than 16 million custom colors using this approach. Some computers cannot display each of the 16 million possible colors; each computer displays the closest color it can to the requested color.

You can discover the red, green, or blue components of any existing color with the methods `getRed()`, `getGreen()`, and `getBlue()`. Each of these methods returns an integer. For example, you can discover the amount of red in `MAGENTA` by displaying the value of `Color.MAGENTA.getRed()`;

Figure 15-4 shows a short application that sets the background color of a `JFrame`'s content pane and sets both the foreground and background colors of a `JButton`. Figure 15-5 shows the output.

```
import java.awt.*;
import javax.swing.*;
import java.awt.Color;
public class JFrameWithColor extends JFrame
{
    private final int SIZE = 180;
    private Container con = getContentPane();
    private JButton button =
        new JButton("Press Me");
    public JFrameWithColor()
    {
        super("Frame");
        setSize(SIZE, SIZE);
        con.setLayout(new FlowLayout());
        con.add(button);
        con.setBackground(Color.YELLOW);
        button.setBackground(Color.RED);
        button.setForeground(Color.WHITE);
    }
    public static void main(String[] args)
    {
        JFrameWithColor frame =
            new JFrameWithColor();
        frame.setVisible(true);
    }
}
```

Figure 15-4 The JFrameWithColor class



Figure 15-5 Execution of the JFrameWithColor application



Because this book is printed in only two colors, you can't see the full effect of setting applications' colors in the figures. However, when you work through the “You Do It” exercises later in this chapter, you can observe the effect of color changes on your own monitor.

## TWO TRUTHS & A LIE

### Using Color

1. The `Color` class can be used with the `setBackground()` and `setForeground()` methods of the `Component` class to make your applications more attractive and interesting.
2. The `Color` class defines named constants that represent 256 colors.
3. You can create your own `Color` object using values that represent the intensities of red, green, and blue you want in your color.

The false statement is #2. The `Color` class defines named constants that represent 13 colors.

## Learning More About Layout Managers

A layout manager is an object that controls the size and position (that is, the layout) of components inside a `Container` object. The layout manager that you assign to the `Container` determines how the components are sized and positioned within it. Layout managers are interface classes that are part of the JDK; they align your components so the components neither crowd each other nor overlap. For example, you have already learned that the `FlowLayout` layout manager positions components in rows from left to right across their container. Other layout managers arrange components in equally spaced columns and rows or center components within their container. Each component you place within a `Container` can also be a `Container` itself, so you can assign layout managers within layout managers. The Java platform supplies layout managers that range from the very simple (`FlowLayout` and `GridLayout`) to the special purpose (`BorderLayout` and `CardLayout`) to the very flexible (`GridBagLayout` and `BoxLayout`). Table 15-2 lists each layout manager and situations in which each is commonly used.

Layout Manager	When to Use
BorderLayout	Use when you add components to a maximum of five sections arranged in north, south, east, west, and center positions
FlowLayout	Use when you need to add components from left to right; <code>FlowLayout</code> automatically moves to the next row when needed, and each component takes its preferred size
GridLayout	Use when you need to add components into a grid of rows and columns; each component is the same size
CardLayout	Use when you need to add components that are displayed one at a time
BoxLayout	Use when you need to add components into a single row or a single column
GridBagLayout	Use when you need to set size, placement, and alignment constraints for every component that you add

**Table 15-2** Java layout managers

## Using BorderLayout

The **BorderLayout manager** is the default manager class for all content panes. You can use the `BorderLayout` class with any container that has five or fewer components. (However, any of the components could be a container that holds even more components.) When you use the `BorderLayout` manager, the components fill the screen in five regions: north, south, east, west, and center. Figure 15-6 shows a `JFrame` that contains five `JButton` objects that fill the five regions in a content pane that uses `BorderLayout`.



**Figure 15-6** Output of the `JDemoBorderLayout` application

When you add a component to a container that uses `BorderLayout`, the `add()` method uses two arguments: the component and the region to which the component is added. The `BorderLayout` class provides five named constants for the regions—`BorderLayout.NORTH`, `.SOUTH`, `.EAST`, `.WEST`, and `.CENTER`—or you can use the Strings those constants represent: “North”, “South”, “East”, “West”, or “Center”. Figure 15-7 shows the class that creates the output in Figure 15-6.

```

import javax.swing.*;
import java.awt.*;
public class JDemoBorderLayout extends JFrame
{
    private JButton nb = new JButton("North Button");
    private JButton sb = new JButton("South Button");
    private JButton eb = new JButton("East Button");
    private JButton wb = new JButton("West Button");
    private JButton cb = new JButton("Center Button");
    private Container con = getContentPane();
    public JDemoBorderLayout()
    {
        con.setLayout(new BorderLayout());
        con.add(nb, BorderLayout.NORTH);
        con.add(sb, BorderLayout.SOUTH);
        con.add(eb, BorderLayout.EAST);
        con.add(wb, BorderLayout.WEST);
        con.add(cb, BorderLayout.CENTER);
        setSize(400, 150);
    }
    public static void main(String[] args)
    {
        JDemoBorderLayout frame = new JDemoBorderLayout();
        frame.setVisible(true);
    }
}

```

**Figure 15-7** The JDemoBorderLayout class



When using `BorderLayout`, you can use the constants `PAGE_START`, `PAGE_END`, `LINE_START`, `LINE_END`, and `CENTER` instead of `NORTH`, `SOUTH`, `EAST`, `WEST`, and `CENTER`. Rather than using geographical references, these constants correspond to positions as you might picture them on a printed page.



Recall from Chapter 13 that in Java 5.0 and later you can use the static import feature, which allows you to use a `static` constant without the class name. For example, if you add the following import statement at the top of your file, you can simply refer to `CENTER` instead of `BorderLayout.CENTER`:  
`import static java.awt.BorderLayout.*;`

When you place exactly five components in a container and use `BorderLayout`, each component fills one entire region, as illustrated in Figure 15-6. When the application runs, Java determines the exact size of each component based on the component's contents. When you resize a `Container` that uses `BorderLayout`, the regions also change in size. If you drag the `Container`'s border to make it wider, the north, south, and center regions become wider, but the east and west regions do not change. If you increase the `Container`'s height, the east, west, and center regions become taller, but the north and south regions do not change.

In Figure 15-7, an anonymous `BorderLayout` object is created when the constructor is called from within the `setLayout()` method. Instead, you could declare a named `BorderLayout` object and use its identifier in the `setLayout()` call. However, it's not necessary to use either technique to specify `BorderLayout` because it is the default layout manager for all content panes; that's why, in many examples in the last chapter, you had to specify `FlowLayout` to acquire the easier-to-use manager.

When you use `BorderLayout`, you are not required to add components into each of the five regions. If you add fewer components, any empty component regions disappear, and the remaining components expand to fill the available space. If any or all of the north, south, east, or west areas are left out, the center area spreads into the missing area or areas. However, if the center area is left out, the north, south, east, or west areas do not change. A common mistake when using `BorderLayout` is to add a `Component` to a content pane or frame without naming a region. This can result in some of the components not being visible.

## Using `FlowLayout`

Recall from the last chapter, *Introduction to Swing Components*, that you can use the **`FlowLayout manager`** class to arrange components in rows across the width of a `Container`. With `FlowLayout`, each `Component` that you add is placed to the right of previously added components in a row; or, if the current row is filled, the `Component` is placed to start a new row.

When you use `BorderLayout`, the `Components` you add fill their regions—that is, each `Component` expands or contracts based on its region's size. However, when you use `FlowLayout`, each `Component` retains its default size, or **preferred size**. For example, a `JButton`'s preferred size is the size that is large enough to hold the `JButton`'s text. When you use `BorderLayout` and then resize the window, the components change size accordingly because their regions change. When you use `FlowLayout` and then resize the window, each component retains its size, but it might become partially obscured or change position.

The `FlowLayout` class contains three constants you can use to align `Components` with a `Container`:

- `FlowLayout.LEFT`
- `FlowLayout.CENTER`
- `FlowLayout.RIGHT`

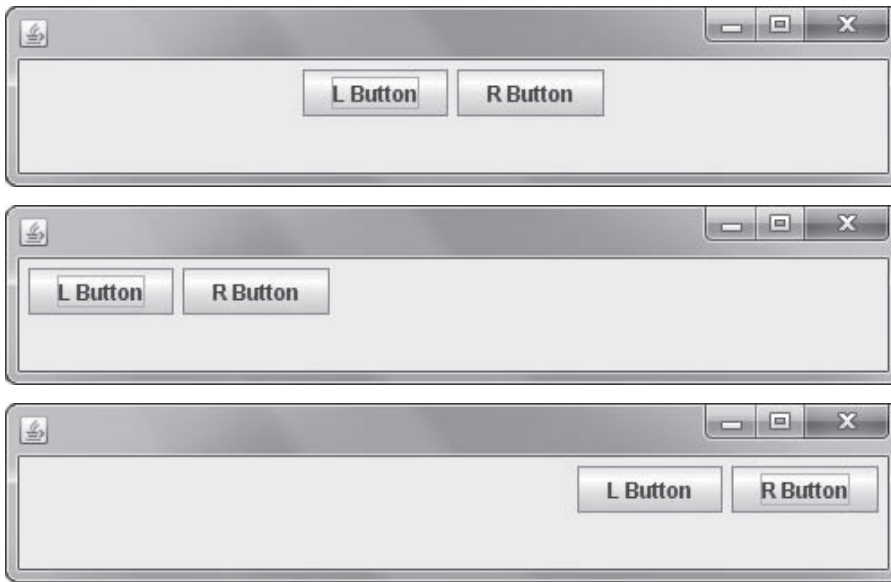
If you do not specify alignment, `Components` are center-aligned in a `FlowLayout` `Container` by default. Figure 15-8 shows an application that uses the `FlowLayout.LEFT` and `FlowLayout.RIGHT` constants to reposition `JButtons`. In this example, a `FlowLayout` object named `layout` is used to set the layout of the content pane. When the user clicks a button, the shaded code in the `actionPerformed()` method changes the alignment to left or right using the `FlowLayout` class `setAlignment()` method. Figure 15-9 shows the application when it starts, how the `JButton` `Components` are repositioned after the user clicks the *L* button, and how the `Components` are repositioned after the user clicks the *R* button.

```
import javax.swing.*;
import java.awt.*;
import java.awt.event.*;
public class JDemoFlowLayout extends JFrame implements ActionListener
{
    private JButton lb = new JButton("L Button");
    private JButton rb = new JButton("R Button");
    private Container con = getContentPane();
    private FlowLayout layout = new FlowLayout();
    public JDemoFlowLayout()
    {
        con.setLayout(layout);
        con.add(lb);
        con.add(rb);
        lb.addActionListener(this);
        rb.addActionListener(this);
        setSize(500, 100);
    }
    public void actionPerformed(ActionEvent event)
    {
        Object source = event.getSource();
        if(source == lb)
            layout.setAlignment(FlowLayout.LEFT);
        else
            layout.setAlignment(FlowLayout.RIGHT);
        con.invalidate();
        con.validate();
    }
    public static void main(String[] args)
    {
        JDemoFlowLayout frame = new JDemoFlowLayout();
        frame.setVisible(true);
    }
}
```

**Figure 15-8** The JDemoFlowLayout application



The last statements in the JDemoFlowLayout class call `invalidate()` and `validate()`. The `invalidate()` call marks the container (and any of its parents) as needing to be laid out. The `validate()` call causes the components to be rearranged based on the newly assigned layout.



**Figure 15-9** The `JDemoFlowLayout` application as it first appears on the screen, after the user chooses the `L` button, and after the user chooses the `R` button

## Using `GridLayout`

If you want to arrange components into equal rows and columns, you can use the **`GridLayout manager`** class. When you create a `GridLayout` object, you indicate the numbers of rows and columns you want, and then the container surface is divided into a grid, much like the screen you see when using a spreadsheet program. For example, the following statement establishes an anonymous `GridLayout` with four horizontal rows and five vertical columns in a `Container` named `con`:

```
con.setLayout(new GridLayout(4, 5));
```

Specifying rows and then columns when you use `GridLayout` might seem natural to you, because this is the approach you take when defining two-dimensional arrays.

As you add new `Components` to a `GridLayout`, they are positioned in sequence from left to right across each row. Unfortunately, you can't skip a position or specify an exact position for a component. (However, you can add a blank label to a grid position to give the illusion of skipping a position.) You also can specify a vertical and horizontal gap measured in pixels, using two additional arguments. For example, Figure 15-10 shows a `JDemoGridLayout` program that uses the shaded statement to establish a `GridLayout` with three horizontal rows and two vertical columns, and horizontal and vertical gaps of five pixels each. Five `JButton` `Components` are added to the `JFrame`'s automatically retrieved content pane.



```

import javax.swing.*;
import java.awt.*;
public class JDemoGridLayout extends JFrame
{
    private JButton b1 = new JButton("Button 1");
    private JButton b2 = new JButton("Button 2");
    private JButton b3 = new JButton("Button 3");
    private JButton b4 = new JButton("Button 4");
    private JButton b5 = new JButton("Button 5");
    private GridLayout layout = new GridLayout(3, 2, 5, 5);
    private Container con = getContentPane();
    public JDemoGridLayout()
    {
        con.setLayout(layout);
        con.add(b1);
        con.add(b2);
        con.add(b3);
        con.add(b4);
        con.add(b5);
        setSize(200, 200);
    }
    public static void main(String[] args)
    {
        JDemoGridLayout frame = new JDemoGridLayout();
        frame.setVisible(true);
    }
}

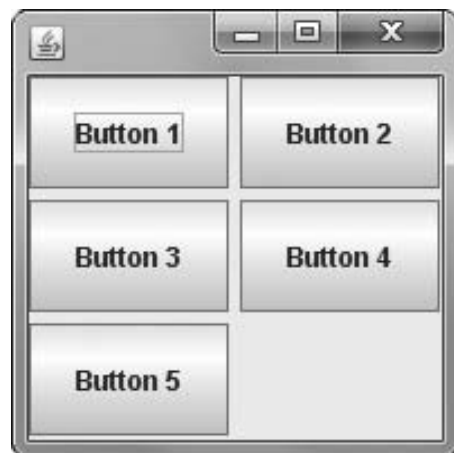
```

**Figure 15-10** The JDemoGridLayout class

Figure 15-11 shows the output of the JDemoGridLayout application. The Components are placed into the pane across the three rows. Because there are six positions but only five Components, one spot remains unused.

With GridLayout, you can specify the number of rows and use 0 for the number of columns to let the layout manager determine the number of columns, or you can use 0 for the number of rows, specify the number of columns, and let the layout manager calculate the number of rows.

When trying to decide whether to use GridLayout or FlowLayout, remember the following:



**Figure 15-11** Output of the JDemoGridLayout program

- Use `GridLayout` when you want components in fixed rows and columns and you want the components' size to fill the available space.
- Use `FlowLayout` if you want Java to determine the rows and columns, do not want a rigid row and column layout, and want components to retain their “natural” size so their contents are fully visible.

## Using CardLayout

The **CardLayout manager** generates a stack of containers or components, one on top of another, much like a blackjack dealer reveals playing cards one at a time from the top of a deck. Each component in the group is referred to as a card, and each card can be any component type—for example, a `JButton`, `JLabel`, or `JPanel`. You use a `CardLayout` when you want multiple components to share the same display space.

A card layout is created from the `CardLayout` class using one of two constructors:

- `CardLayout()` creates a card layout without a horizontal or vertical gap.
- `CardLayout(int hgap, int vgap)` creates a card layout with the specified horizontal and vertical gaps. The horizontal gaps are placed at the left and right edges. The vertical gaps are placed at the top and bottom edges.

For example, Figure 15-12 shows a `JDemoCardLayout` class that uses a `CardLayout` manager to create a stack of `JButtons` that contain the labels “Ace of Hearts”, “Three of Spades”, and “Queen of Clubs”. In the class constructor, you need a slightly different version of the `add()` method to add a component to a content pane whose layout manager is `CardLayout`. The format of the method is:

```
add(aString, aContainer);
```

In this statement, `aString` represents a name you want to use to identify the `Component` card that is added.

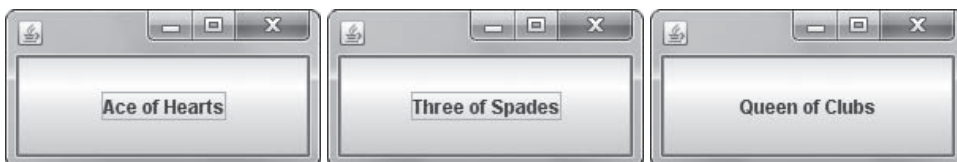
In a program that has a `CardLayout` manager, a change of cards is usually triggered by a user's action. For example, in the `JDemoCardLayout` program, each `JButton` can trigger the `actionPerformed()` method. Within this method, the statement `next(getContentPane())` flips to the next card of the container. (The order of the cards depends on the order in which you add them to the container.) You also can use `previous(getContentPane());`, `first(getContentPane());`, and `last(getContentPane());` to flip to the previous, first, and last card, respectively. You can go to a specific card by using the `String` name assigned in the `add()` method call. For example, in the application in Figure 15-12, the following statement would display the “Three of Spades” because “three” is used as the first argument when the `b2` object is added to the content pane in the `JDemoCardLayout` constructor:

```
cards.show(getContentPane(), "three");
```

```
import javax.swing.*;
import java.awt.*;
import java.awt.event.*;
public class JDemoCardLayout extends JFrame
    implements ActionListener
{
    private CardLayout cards = new CardLayout();
    private JButton b1 = new JButton("Ace of Hearts");
    private JButton b2 = new JButton("Three of Spades");
    private JButton b3 = new JButton("Queen of Clubs");
    private Container con = getContentPane();
    public JDemoCardLayout()
    {
        con.setLayout(cards);
        con.add("ace", b1);
        b1.addActionListener(this);
        con.add("three", b2);
        b2.addActionListener(this);
        con.add("queen", b3);
        b3.addActionListener(this);
        setSize(200, 100);
    }
    public void actionPerformed(ActionEvent e)
    {
        cards.next(getContentPane());
    }
    public static void main(String[] args)
    {
        JDemoCardLayout frame = new JDemoCardLayout();
        frame.setVisible(true);
    }
}
```

**Figure 15-12** The JDemoCardLayout class

Figure 15-13 shows the output of the JDemoCardLayout program when it first appears on the screen, after the user clicks the button once, and after the user clicks the button a second time. Because each JButton is a card, each JButton consumes the entire viewing area in the container that uses the CardLayout manager. If the user continued to click the card buttons in Figure 15-13, the cards would continue to cycle in order.



**Figure 15-13** Output of JDemoCardLayout when it first appears on the screen, after the user clicks once, and after the user clicks twice



The `JTabbedPane` class operates like a container with a `CardLayout`, but folder-type tabs are in place for the user to select the various components. You can find out more about the class at <http://java.sun.com>.

## Using Advanced Layout Managers

Just as professional Java programmers are constantly creating new Components, they also create new layout managers. You are certain to encounter new and interesting layout managers during your programming career; you might even create your own.

For example, when `GridLayout` is not sophisticated enough for your purposes, you can use `GridBagLayout`. The **GridBagLayout manager** allows you to add Components to precise locations within the grid, as well as to indicate that specific Components should span multiple rows or columns within the grid. For example, if you want to create a `JPanel` with six `JButtons`, in which two of the `JButtons` are twice as wide as the others, you can use `GridBagLayout`. This class is difficult to use because you must set the position and size for each component, and more than 20 methods are associated with the class. Visit <http://java.sun.com> for details on how to use this class.

Another layout manager option is the **BoxLayout manager**, which allows multiple components to be laid out either vertically or horizontally. The components do not wrap, so a vertical arrangement of components, for example, stays vertically arranged when the frame is resized. The Java Web site can provide you with details.



Watch the video *Layout Managers*.

### TWO TRUTHS & A LIE

#### Learning More About Layout Managers

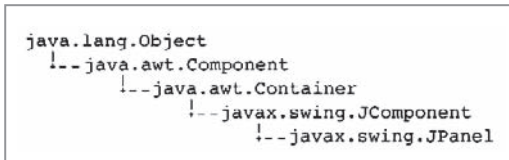
1. The `FlowLayout` manager is the default manager class for all content panes.
2. The `BorderLayout` manager can directly hold only up to five components.
3. The `GridLayout` manager arranges components in rows and columns.

The false statement is #1. The `BorderLayout` manager is the default manager class for all content panes.

## Using the `JPanel` Class

Using the `BorderLayout`, `FlowLayout`, `GridLayout`, and `CardLayout` managers would provide a limited number of screen arrangements if you could place only one Component in a section of the layout. Fortunately, you can greatly increase the number of possible component arrangements by

using the `JPanel` class. A **JPanel** is a plain, borderless surface that can hold lightweight UI components. Figure 15-14 shows the inheritance hierarchy of the `JPanel` class. You can see that every `JPanel` is a `Container`; you use a `JPanel` to hold other UI components, such as `JButtons`, `JCheckBoxes`, or even other `JPanels`. By using `JPanels` within `JPanels`, you can create an infinite variety of screen layouts. The default layout manager for every `JPanel` is `FlowLayout`.



**Figure 15-14** The inheritance hierarchy of the `JPanel` class

To add a component to a `JPanel`, you call the container's `add()` method, using the component as the argument. For example, Figure 15-15 shows the code that creates a `JFrameWithPanels` class that extends `JFrame`. A `JButton` is added to a `JPanel` named `panel1`, and two more `JButtons` are added to another `JPanel` named `panel2`. Then `panel1` and `panel2` are added to the `JFrame`'s content pane.

```

import javax.swing.*;
import java.awt.*;
import java.awt.Color;
public class JFrameWithPanels extends JFrame
{
    private final int WIDTH = 250;
    private final int HEIGHT = 120;
    private JButton button1 = new JButton("One");
    private JButton button2 = new JButton("Two");
    private JButton button3 = new JButton("Three");
    public JFrameWithPanels()
    {
        super("JFrame with Panels");
        setDefaultCloseOperation(JFrame.EXIT_ON_CLOSE);
        JPanel panel1 = new JPanel();
        JPanel panel2 = new JPanel();
        Container con = getContentPane();
        con.setLayout(new FlowLayout());
        con.add(panel1);
        con.add(panel2);
        panel1.add(button1);
        panel1.setBackground(Color.BLUE);
        panel2.add(button2);
        panel2.add(button3);
        panel2.setBackground(Color.BLUE);
        setSize(WIDTH, HEIGHT);
    }
}
  
```

**Figure 15-15** The `JFrameWithPanels` class (continues)

(continued)

```
public static void main(String[] args)
{
    JFrameWithPanels frame = new JFrameWithPanels();
    frame.setVisible(true);
}
}
```

**Figure 15-15** The `JFrameWithPanels` class

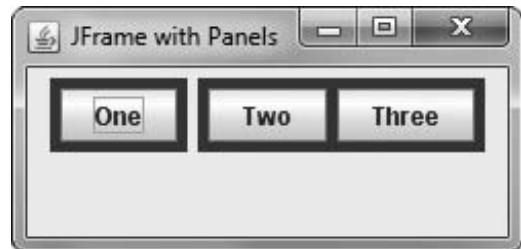
Figure 15-16 shows the output of the `JFrameWithPanels` program. Two `JPanel`s have been added to the `JFrame`. Because this application uses the `setBackground()` method to make each `JPanel`'s background blue, you can see where one panel ends and the other begins. The first `JPanel` contains a single `JButton` and the second one contains two `JButtons`.

When you create a `JPanel` object, you can use one of four constructors. The different constructors allow you to use default values or to specify a layout manager and whether the `JPanel` is double buffered. If you indicate **double buffering**, which is the default buffering strategy, you specify that additional memory space will be used to draw the `JPanel` off screen when it is updated. With double buffering, a redrawn `JPanel` is displayed only when it is complete; this provides the viewer with updated screens that do not flicker while being redrawn. The four constructors are as follows:

- `JPanel()` creates a `JPanel` with double buffering and a flow layout.
- `JPanel(LayoutManager layout)` creates a `JPanel` with the specified layout manager and double buffering.
- `JPanel(boolean isDoubleBuffered)` creates a `JPanel` with a flow layout and the specified double-buffering strategy.
- `JPanel(LayoutManager layout, boolean isDoubleBuffered)` creates a `JPanel` with the specified layout manager and the specified buffering strategy.



When you employ double buffering, the visible screen surface is called the **primary surface**, and the off-screen image is called the **back buffer**. The act of copying the contents from one surface to another is frequently referred to as a **block line transfer**, or **blitting**, because of the acronym *blit*, pronounced *blit*. Double buffering prevents “tearing,” the visual effect that occurs when you see parts of different images because the redrawing rate is not fast enough. As with most beneficial features, double buffering has a cost: additional memory requirements.



**Figure 15-16** Output of the `JFrameWithPanels` application

As with many aspects of Java, there are multiple ways to achieve the same results. For example, each of the following techniques creates a `JPanel` that uses a `BorderLayout` manager:

- You can create a named layout and use it as an argument in a `JPanel` constructor:

```
BorderLayout border = new BorderLayout();
JPanel myPanel = new JPanel(border);
```

- You can use an anonymous layout manager in the `JPanel` constructor:

```
JPanel myPanel = new JPanel(new BorderLayout());
```

- You can create a `JPanel` and then set its layout manager using the `setLayout()` method:

```
JPanel myPanel = new JPanel();
myPanel.setLayout(new BorderLayout());
```

When a `JPanel` will have a layout other than `FlowLayout`, specifying the layout manager when you create the `JPanel` is preferable for performance reasons. If you create the `JPanel` first and change its layout later, you automatically create an unnecessary `FlowLayout` object for the original instantiation.

You add components to a `JPanel` with the `add()` method. Figure 15-17 shows a `JDemoManyPanels` program in which the `JFrame` contains four `JPanel`s and 12 `JButton`s that each display a single spelled-out number so you can better understand their positions. The automatically supplied content pane for the `JFrame` is assigned a `BorderLayout`, and each `JPanel` is assigned either a `GridLayout` or `FlowLayout` and placed in one of the regions (leaving the north region empty). One or more `JButton`s are then placed on each `JPanel`. Figure 15-18 shows the output as the user adjusts the borders of the `JFrame` to change its size. Using the code as a guide, be certain you understand why each `JButton` appears as it does in the `JFrame`.

```
import javax.swing.*;
import java.awt.*;
public class JDemoManyPanels extends JFrame
{
    // Twelve buttons
    private JButton button01 = new JButton("One");
    private JButton button02 = new JButton("Two");
    private JButton button03 = new JButton("Three");
    private JButton button04 = new JButton("Four");
    private JButton button05 = new JButton("Five");
    private JButton button06 = new JButton("Six");
    private JButton button07 = new JButton("Seven");
    private JButton button08 = new JButton("Eight");
    private JButton button09 = new JButton("Nine");
    private JButton button10 = new JButton("Ten");
    private JButton button11 = new JButton("Eleven");
    private JButton button12 = new JButton("Twelve");
```

**Figure 15-17** The `JDemoManyPanels` class (continues)

(continued)

```
// Four panels
private JPanel panel01 = new JPanel(new GridLayout(2, 0));
private JPanel panel02 = new JPanel(new FlowLayout());
private JPanel panel03 = new JPanel(new FlowLayout());
private JPanel panel04 = new JPanel(new GridLayout(2, 0));

public JDemoManyPanels()
{
    setLayout(new BorderLayout());
    add(panel01, BorderLayout.WEST);
    add(panel02, BorderLayout.CENTER);
    add(panel03, BorderLayout.SOUTH);
    add(panel04, BorderLayout.EAST);

    panel01.add(button01);
    panel01.add(button02);
    panel01.add(button03);

    panel02.add(button04);
    panel02.add(button05);
    panel02.add(button06);

    panel03.add(button07);

    panel04.add(button08);
    panel04.add(button09);
    panel04.add(button10);
    panel04.add(button11);
    panel04.add(button12);

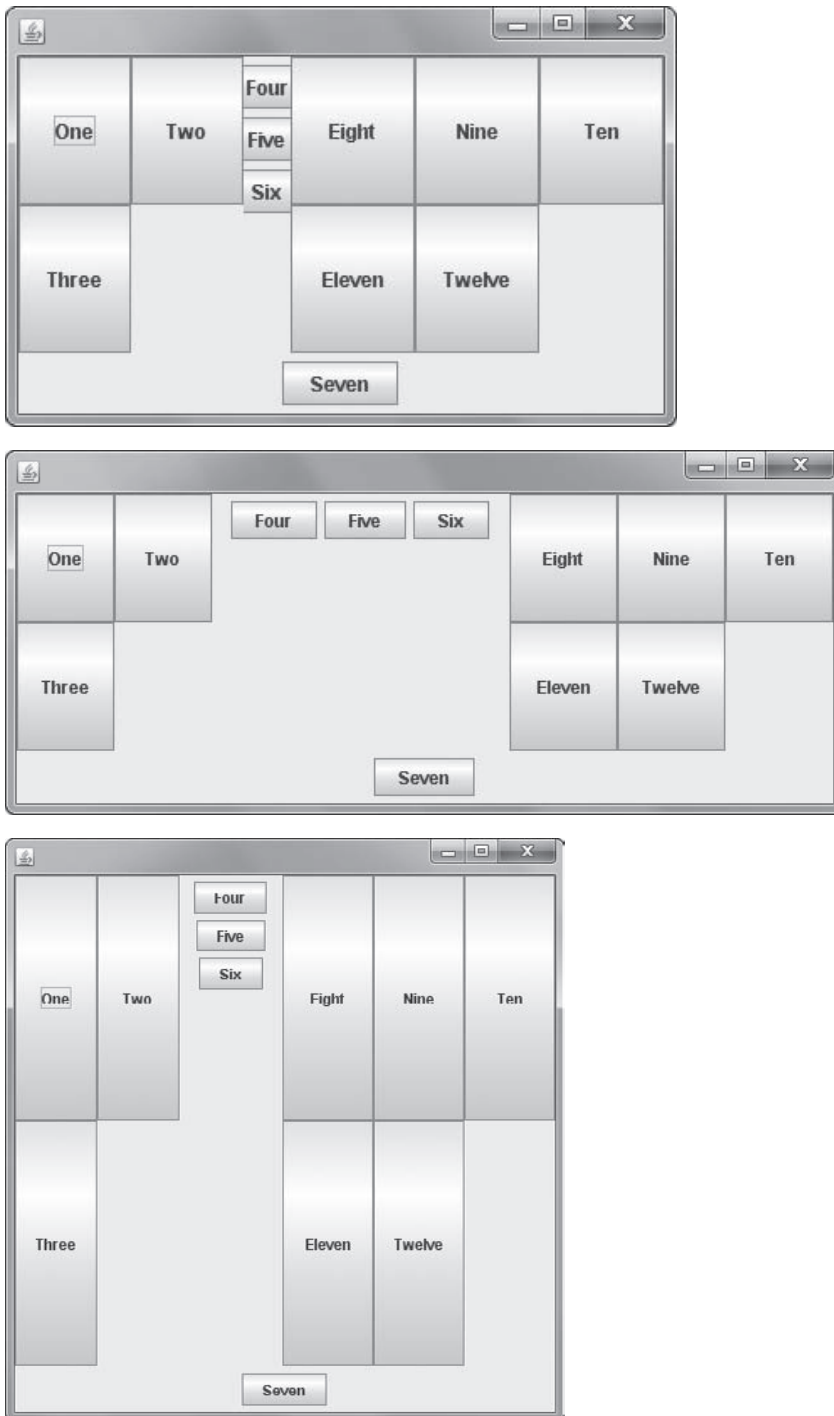
    setSize(400, 250);
}
public static void main(String[] args)
{
    JDemoManyPanels frame = new JDemoManyPanels();
    frame.setVisible(true);
}
}
```

**Figure 15-17** The JDemoManyPanels class



If you were creating a program with as many buttons and panels as the one in Figure 15-17, you might prefer to create arrays of the components instead of so many individually named ones. This example does not use an array so you can more easily see how each component is placed.





**Figure 15-18** Output of the `JDemoManyPanel1`'s program: three views as the user adjusts the `JFrame` borders



Swing containers other than `JPanel` and content panes generally provide Application Program Interface (API) methods that you should use instead of the `add()` method. See the Java Web site at <http://java.sun.com> for details.

`GridLayout` provides you with rows and columns that are similar to a two-dimensional array. Therefore, it particularly lends itself to displaying arrays of objects. For example, Figure 15-19 contains a `Checkerboard` class that displays a pattern of eight rows and columns in alternating colors. The `JPanel` placed in the content pane has a `GridLayout` of eight by eight. Sixty-four `JPanel`s are declared, and in a loop, one by one, they are instantiated and assigned to a section of the grid (see shaded statements). After each set of eight `JPanel`s is assigned to the grid (when `x` is evenly divisible by 8), the first and second color values are reversed, so that the first row starts with a blue square, the second row starts with a white square, and so on. Within each row, all the even-positioned squares are filled with one color, and the odd-positioned squares are filled with the other. Figure 15-20 shows the output.

```
import java.awt.*;
import javax.swing.*;
import java.awt.Color;
public class Checkerboard extends JFrame
{
    private final int ROWS = 8;
    private final int COLS = 8;
    private final int GAP = 2;
    private final int NUM = ROWS * COLS;
    private int x;
    private JPanel pane = new JPanel
        (new GridLayout(ROWS, COLS, GAP, GAP));
    private JPanel[] panel = new JPanel[NUM];
    private Color color1 = Color.WHITE;
    private Color color2 = Color.BLUE;
    private Color tempColor;
    public Checkerboard()
    {
        super("Checkerboard");
        setDefaultCloseOperation(JFrame.EXIT_ON_CLOSE);
        add(pane);
        for(x = 0; x < NUM; ++x)
        {
            panel[x] = new JPanel();
            pane.add(panel[x]);
            if(x % COLS == 0)
            {
                tempColor = color1;
                color1 = color2;
                color2 = tempColor;
            }
        }
    }
}
```

Figure 15-19 The `Checkerboard` class (continues)

(continued)

```
        if(x % 2 == 0)
            panel[x].setBackground(color1);
        else
            panel[x].setBackground(color2);
    }
}
public static void main(String[] args)
{
    Checkerboard frame = new Checkerboard();
    final int SIZE = 300;
    frame.setSize(SIZE, SIZE);
    frame.setVisible(true);
}
}
```

Figure 15-19 The Checkerboard class

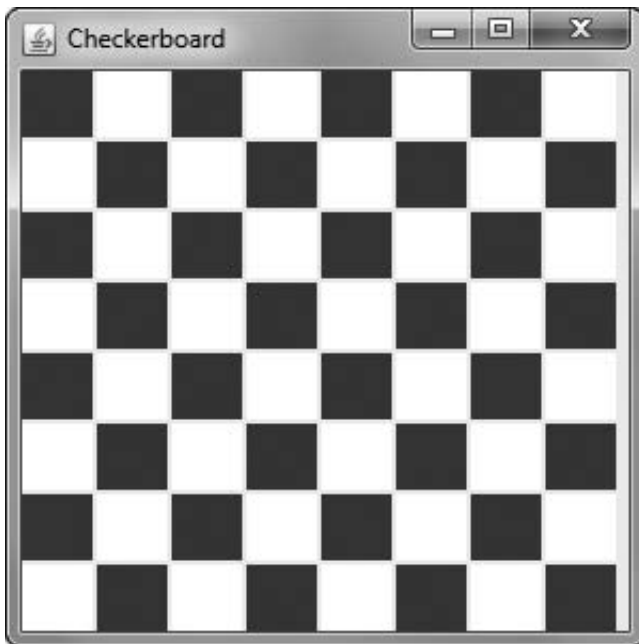


Figure 15-20 Output of the Checkerboard application



When creating the `Checkerboard` class, you might be tempted to create just two `JPanel`s, one blue and one white, and add them to the content pane multiple times. However, each GUI component can be contained only once. If a component is already in a container and you try to add it to another container, the component will be removed from the first container and then added to the second.



Watch the video *The JPanel Class*.

722

## TWO TRUTHS & A LIE

### Using the JPanel Class

1. A JPanel is a plain, borderless surface that can hold lightweight UI components.
2. To add a component to a JPanel, you call the component's `add()` method, using the JPanel as the argument.
3. Different JPanel constructors allow you to use default values or to specify a layout manager and whether the JPanel is double buffered.

The false statement is #2. To add a component to a JPanel, you call the container's `add()` method, using the component as the argument.

## Creating JScrollPane

When components in a Swing UI require more display area than they have been allocated, you can use a JScrollPane container to hold the components in a way that allows a user to scroll initially invisible parts of the pane into view. A JScrollPane provides scroll bars along the side or bottom of a pane, or both, with a viewable area called a **viewport**. Figure 15-21 displays the inheritance hierarchy of the JScrollPane class.

```

java.lang.Object
  |-- java.awt.Component
        |-- java.awt.Container
              |-- javax.swing.JComponent
                    |-- javax.swing.JScrollPane
  
```

**Figure 15-21** The inheritance hierarchy of the JScrollPane class

The JScrollPane constructor takes one of four forms:

- JScrollPane() creates an empty JScrollPane in which both horizontal and vertical scroll bars appear when needed.
- JScrollPane(Component) creates a JScrollPane that displays the contents of the specified component.

- `JScrollPane(Component, int, int)` creates a `JScrollPane` that displays the specified component and includes both vertical and horizontal scroll bar specifications.
- `JScrollPane(int, int)` creates a `JScrollPane` with both vertical and horizontal scroll bar specifications.

When you create a simple scroll pane using the constructor that takes no arguments, as in the following example, horizontal and vertical scroll bars appear only if they are needed; that is, if the contents of the pane cannot be fully displayed without them:

```
JScrollPane aScrollPane = new JScrollPane();
```

To force the display of a scroll bar, you can use class variables defined in the `ScrollPaneConstants` class, as follows:

```
ScrollPaneConstants.HORIZONTAL_SCROLLBAR_AS_NEEDED
```

```
ScrollPaneConstants.HORIZONTAL_SCROLLBAR_ALWAYS
```

```
ScrollPaneConstants.HORIZONTAL_SCROLLBAR_NEVER
```

```
ScrollPaneConstants.VERTICAL_SCROLLBAR_AS_NEEDED
```

```
ScrollPaneConstants.VERTICAL_SCROLLBAR_ALWAYS
```

```
ScrollPaneConstants.VERTICAL_SCROLLBAR_NEVER
```

For example, the following code creates a scroll pane that displays an image named `picture`, a vertical scroll bar, and no horizontal scroll bar:

```
JScrollPane scroll = new JScrollPane(picture,
    ScrollPaneConstants.VERTICAL_SCROLLBAR_ALWAYS,
    ScrollPaneConstants.HORIZONTAL_SCROLLBAR_NEVER);
```

Figure 15-22 shows a `JScrollDemo` class in which a label with a large font is added to a panel. The scroll pane named `scroll` includes the panel and two scroll bars.

```
import javax.swing.*;
import java.awt.*;
public class JScrollDemo extends JFrame
{
    private JPanel panel = new JPanel();
    private JScrollPane scroll = new JScrollPane(panel,
        ScrollPaneConstants.VERTICAL_SCROLLBAR_ALWAYS,
        ScrollPaneConstants.HORIZONTAL_SCROLLBAR_ALWAYS);
    private JLabel label = new JLabel("Four score and seven");
    private Font bigFont = new Font("Arial", Font.PLAIN, 20);
    private Container con;
    public JScrollDemo()
    {
        super("JScrollDemo");
        setDefaultCloseOperation(JFrame.EXIT_ON_CLOSE);
        con = getContentPane();
        label.setFont(bigFont);
    }
}
```

**Figure 15-22** The `JScrollDemo` application (*continues*)

(continued)

```

        con.add(scroll);
        panel.add(label);
    }
    public static void main(String[] args)
    {
        final int WIDTH = 180;
        final int HEIGHT = 100;
        JScrollDemo aFrame = new JScrollDemo();
        aFrame.setSize(WIDTH, HEIGHT);
        aFrame.setVisible(true);
    }
}

```

**Figure 15-22** The JScrollDemo application

The JScrollDemo object in the program in Figure 15-22 is purposely set small enough (180 × 100) so that only part of the label it contains is visible at a time. A user can slide the scroll bars to view the entire label. Figure 15-23 shows the output with the scroll bar in two positions.



**Figure 15-23** Output of the JScrollDemo application

## TWO TRUTHS & A LIE

### Creating JScrollPane

1. A JScrollPane can provide scroll bars along the side or bottom of a pane, or both.
2. When you create a simple scroll pane using the constructor that takes no arguments, horizontal and vertical scroll bars appear only if they are needed.
3. You cannot force the display of a scroll bar in a JScrollPane unless the components it contains require too much room.

The false statement is #3. You can use class variables defined in the JScrollPaneConstants class to force the display of a scroll bar.

## A Closer Look at Events and Event Handling

In the chapter *Introduction to Swing Components*, you worked with `ActionEvents` and `ItemEvents` that are generated when a user works with a control that is included in one of your programs. The parent class for all events is `EventObject`, which descends from the `Object` class. `EventObject` is the parent of `AWTEvent`, which in turn is the parent of specific event classes such as `ActionEvent` and `ItemEvent`. The abstract class `AWTEvent` is contained in the package `java.awt.event`. Although you might think it would have been logical for the developers to name the event base class `Event`, there is no currently active, built-in Java class named `Event` (although there was one in Java 1.0).

Figure 15-24 illustrates the inheritance hierarchy of these relationships.



**Figure 15-24** The inheritance hierarchy of event classes

You can see in Figure 15-24 that `ComponentEvent` is a parent to several event classes, including `InputEvent`, which is a parent of `KeyEvent` and `MouseEvent`. The family tree for events has roots that go fairly deep, but the class names are straightforward, and they share basic roles within your programs. For example, `ActionEvents` are generated by components that users can click, such as `JButtons`, and `TextEvents` are generated by components into which the user enters text, such as `JTextFields`. `MouseEvents` include clicking a component, and you can cull information from a `MouseEvent` such as determining the location of the mouse pointer and distinguishing between a single- and double-click. Table 15-3 lists some common user actions and the events that are generated from them.

User Action	Resulting Event Type
Click a button	ActionEvent
Click a component	MouseEvent
Click an item in a list box	ItemEvent
Click an item in a check box	ItemEvent
Change text in a text field	TextEvent
Open a window	WindowEvent
Iconify a window	WindowEvent
Press a key	KeyEvent

**Table 15-3** Examples of user actions and their resulting event types

Because `ActionEvents` involve the mouse, it is easy to confuse `ActionEvents` and `MouseEvents`. If you are interested in `ActionEvents`, you focus on changes in a component (for example, a `JButton` on a `JFrame` being pressed); if you are interested in `MouseEvents`, your focus is on what the user does manually with the mouse (for example, clicking the left mouse button).

When you write programs with GUIs, you are always handling events that originate with the mouse or keys on specific `Components` or `Containers`. Just as your telephone notifies you when you have a call, the computer's operating system notifies the user when an `AWTEvent` occurs; for example, when the mouse is clicked. Just as you can ignore your phone when you're not expecting or interested in a call, you can ignore `AWTEvents`. If you don't care about an event, such as when your program contains a component that produces no effect when clicked, you simply don't look for a message to occur.

When you care about events—that is, when you want to listen for an event—you can implement an appropriate interface for your class. Each event class shown in Table 15-3 has a listener interface associated with it, so that for every event class, `<name>Event`, there is a similarly named `<name>Listener` interface. For example, `ActionEvent` has an `ActionListener` interface. (The `MouseEvent` class has an additional listener besides `MouseListener`; it is called `MouseMotionListener`.)



Remember that an interface contains only abstract methods, so all interface methods are empty. If you implement a listener, you must provide your own methods for all the methods that are part of the interface. Of course, you can leave the methods empty in your implementation, providing a header and curly braces but no statements.

Every `<name>Listener` interface method has the return type `void`, and each takes one argument: an object that is an instance of the corresponding `<name>Event` class. Thus, the `ActionListener` interface has an event handler method named `actionPerformed()`, and its header is `void actionPerformed(ActionEvent e)`. When an action takes place, the `actionPerformed()` method executes, and `e` represents an instance of that event. Instead of implementing a listener class, you can extend an adapter class. An **adapter class** implements all the methods in an interface, providing an empty body for each method. For example, the



`MouseAdapter` class provides an empty method for all the methods contained in `MouseListener`. The advantage to extending an adapter class instead of implementing a listener class is that you need to write only the methods you want to use, and you do not have to bother creating empty methods for all the others. (If a listener has only one method, there is no need for an adapter. For example, the `ActionListener` class has one method, `actionPerformed()`, so there is no `ActionAdapter` class.)

Whether you use a listener or an adapter, you create an event handler when you write code for the listener methods; that is, you tell your class how to handle the event. After you create the handler, you must also register an instance of the class with the component that you want the event to affect. For any `<name>Listener`, you must use the form `object.add<name>Listener(Component)` to register an object with the `Component` that will listen for objects emanating from it. The `add<name>Listener()` methods, such as `addActionListener()` and `addItemListener()`, all work the same way. They register a listener with a `Component`, return `void`, and take a `<name>Listener` object as an argument. For example, if a `JFrame` is an `ActionListener` and contains a `JButton` named `pushMe`, then the following statement registers this `JFrame` as a listener for the `pushMe` `JButton`:

```
pushMe.addActionListener(this);
```

Table 15-4 lists the events with their listeners and handlers.

Event	Listener(s)	Handler(s)
ActionEvent	ActionListener	actionPerformed(ActionEvent)
ItemEvent	ItemListener	itemStateChanged(ItemEvent)
TextEvent	TextListener	textValueChanged(TextEvent)
AdjustmentEvent	AdjustmentListener	adjustmentValueChanged (AdjustmentEvent)
ContainerEvent	ContainerListener	componentAdded(ContainerEvent) componentRemoved(ContainerEvent)
ComponentEvent	ComponentListener	componentMoved(ComponentEvent) componentHidden(ComponentEvent) componentResized(ComponentEvent) componentShown(ComponentEvent)
FocusEvent	FocusListener	focusGained(FocusEvent) focusLost(FocusEvent)
MouseEvent	MouseListener MouseMotionListener	mousePressed(MouseEvent) mouseReleased(MouseEvent) mouseEntered(MouseEvent) mouseExited(MouseEvent) mouseClicked(MouseEvent) mouseDragged(MouseEvent) mouseMoved(MouseEvent)

**Table 15-4** Events with their related listeners and handlers (*continues*)

*(continued)*

Event	Listener(s)	Handler(s)
KeyEvent	KeyListener	keyPressed(KeyEvent) keyTyped(KeyEvent) keyReleased(KeyEvent)
WindowEvent	WindowListener	windowActivated(WindowEvent) windowClosing(WindowEvent) windowClosed(WindowEvent) windowDeiconified(WindowEvent) windowIconified(WindowEvent) windowOpened(WindowEvent)
MouseEvent	MouseListener	mouseClicked(MouseEvent) mouseEntered(MouseEvent) mouseExited(MouseEvent) mouseMoved(MouseEvent) mousePressed(MouseEvent) mouseReleased(MouseEvent)

**Table 15-4** Events with their related listeners and handlers

## An Event-Handling Example: KeyListener

You use the **KeyListener interface** when you are interested in actions the user initiates from the keyboard. The `KeyListener` interface contains three methods: `keyPressed()`, `keyTyped()`, and `keyReleased()`. For most keyboard applications in which the user must press a keyboard key, it is probably not important whether you take resulting action when a user first presses a key, during the key press, or upon the key's release; most likely, these events occur in quick sequence. However, on those occasions when you don't want to take action while the user holds down the key, you can place the actions in the `keyReleased()` method. It is best to use the `keyTyped()` method when you want to discover which character was typed. When the user presses a key that does not generate a character, such as a function key (sometimes called an **action key**), `keyTyped()` does not execute. The methods `keyPressed()` and `keyReleased()` provide the only ways to get information about keys that don't generate characters. The `KeyEvent` class contains constants known as **virtual key codes** that represent keyboard keys that have been pressed. For example, when you type *A*, two virtual key codes are generated: `Shift` and `"a"`. The virtual key code constants have names such as `VK_SHIFT` and `VK_ALT`. See the Java Web site for a complete list of virtual key codes. Figure 15-25 shows a `JDemoKeyFrame` class that uses the `keyTyped()` method to discover which key the user typed last.



Java programmers call `keyTyped()` events “higher-level” events because they do not depend on the platform or keyboard layout. (For example, the key that generates `VK_Q` on a U.S. keyboard layout generates `VK_A` on a French keyboard layout.) In contrast, `keyPressed()` and `keyReleased()` events are “lower-level” events and do depend on the platform and keyboard layout. According to the Java documentation, using `keyTyped()` is the preferred way to find out about character input.

```
import javax.swing.*;
import java.awt.*;
import java.awt.event.*;
public class JDemoKeyFrame extends JFrame
    implements KeyListener
{
    private JLabel prompt = new JLabel("Type keys below:");
    private JLabel outputLabel = new JLabel();
    private JTextField textField = new JTextField(10);
    public JDemoKeyFrame()
    {
        setTitle("JKey Frame");
        setDefaultCloseOperation(JFrame.EXIT_ON_CLOSE);
        setLayout(new BorderLayout());
        add(prompt, BorderLayout.NORTH);
        add(textField, BorderLayout.CENTER);
        add(outputLabel, BorderLayout.SOUTH);
        addKeyListener(this);
        textField.addKeyListener(this);
    }
    public void keyTyped(KeyEvent e)
    {
        char c = e.getKeyChar();
        outputLabel.setText("Last key typed: " + c);
    }
    public void keyPressed(KeyEvent e)
    {
    }
    public void keyReleased(KeyEvent e)
    {
    }
    public static void main(String[] args)
    {
        JDemoKeyFrame keyFrame = new JDemoKeyFrame();
        final int WIDTH = 250;
        final int HEIGHT = 100;
        keyFrame.setSize(WIDTH, HEIGHT);
        keyFrame.setVisible(true);
    }
}
```

**Figure 15-25** The JDemoKeyFrame class

A prompt in the north border area asks the user to type in the text field in the center area. With each key press by the user, the `keyTyped()` method changes the label in the south border area of the frame to display the key that generated the most recent `KeyEvent`. Figure 15-26 shows the output after the user has typed several characters into the text field.



**Figure 15-26** Output of the `JDemoKeyFrame` application after the user has typed several characters



Watch the video *Event Handling*.

## TWO TRUTHS & A LIE

### A Closer Look at Events and Event Handling

1. `ActionEvents` are generated by components that users can click, `TextEvents` are generated by components into which the user enters text, and `MouseEvents` are generated by mouse actions.
2. Every `<name>Listener` interface method has a return type that refers to an instance of the corresponding `<name>Event` class.
3. An adapter class implements all the methods in an interface, providing an empty body for each method.

The false statement is #2. Every `<name>Listener` interface method has the return type `void`, and each takes one argument: an object that is an instance of the corresponding `<name>Event` class.

## Using `AWTEvent` Class Methods

In addition to the handler methods included with the event listener interfaces, the `AWTEvent` classes themselves contain many other methods that return information about an event. For example, the `ComponentEvent` class contains a `getComponent()` method that allows you to determine which of multiple `Component`s generates an event. The `WindowEvent` class contains a similar method, `getWindow()`, that returns the `Window` that is the source of an event. Table 15-5 lists some useful methods for many of the event classes. All `Component`s have these methods:

- `addComponentListener()`
- `addFocusListener()`

- `addMouseListener()`
- `addMouseMotionListener()`

Class	Method	Purpose
EventObject	Object <code>getSource()</code>	Returns the Object involved in the event
ComponentEvent	Component <code>getComponent()</code>	Returns the Component involved in the event
WindowEvent	Window <code>getWindow()</code>	Returns the Window involved in the event
ItemEvent	Object <code>getItem()</code>	Returns the Object that was selected or deselected
ItemEvent	int <code>getStateChange()</code>	Returns an integer named <code>ItemEvent.SELECTED</code> or <code>ItemEvent.DESELECTED</code>
InputEvent	int <code>getModifiers()</code>	Returns an integer to indicate which mouse button was clicked
InputEvent	int <code>getWhen()</code>	Returns a time indicating when the event occurred
InputEvent	boolean <code>isAltDown()</code>	Returns whether the Alt key was pressed when the event occurred
InputEvent	boolean <code>isControlDown()</code>	Returns whether the Ctrl key was pressed when the event occurred
InputEvent	boolean <code>isShiftDown()</code>	Returns whether the Shift key was pressed when the event occurred
KeyEvent	int <code>getKeyChar()</code>	Returns the Unicode character entered from the keyboard
MouseEvent	int <code>getClickCount()</code>	Returns the number of mouse clicks; lets you identify the user's double-clicks
MouseEvent	int <code>getX()</code>	Returns the x-coordinate of the mouse pointer
MouseEvent	int <code>getY()</code>	Returns the y-coordinate of the mouse pointer
MouseEvent	Point <code>getPoint()</code>	Returns the Point Object that contains the x- and y-coordinates of the mouse location

**Table 15-5** Useful event class methods

You can call any of the methods listed in Table 15-5 by using the object-dot-method format that you use with all class methods. For example, if you have a `KeyEvent` named `inputEvent` and an integer named `unicodeVal`, the following statement is valid:

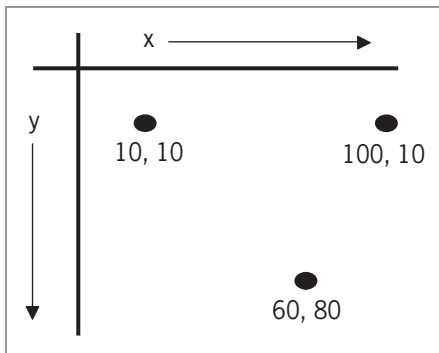
```
unicodeVal = inputEvent.getKeyChar();
```

When you use an event, you can use any of the event's methods, and through the power of inheritance, you can also use methods that belong to any superclass of the event. For example, any `KeyEvent` has access to the `InputEvent`, `ComponentEvent`, `AWTEvent`, `EventObject`, and `Object` methods, as well as to the `KeyEvent` methods.

732

## Understanding x- and y-Coordinates

Table 15-5 refers to x- and y-coordinates of a mouse pointer. A window or frame consists of a number of horizontal and vertical pixels on the screen. Any component you place on the screen has a horizontal, or **x-axis**, position as well as a vertical, or **y-axis**, position in the window. The upper-left corner of any display is position 0, 0. The first, or **x-coordinate**, value increases as you travel from left to right across the window. The second, or **y-coordinate**, value increases as you travel from top to bottom. Figure 15-27 illustrates some screen coordinate positions.



**Figure 15-27** Screen coordinate positions

### TWO TRUTHS & A LIE

#### Using AWTEvent Class Methods

1. You use many of the `AWTEvent` class methods to determine the nature of events and facts about an event.
2. The `getSource()` method returns the `Object` involved in an event, and the `getComponent()` method returns the `Component` involved in an event.
3. The methods `isAltDown()` and `isShiftDown()` are `ActionEvent` methods.

The false statement is #3. The methods `isAltDown()` and `isShiftDown()` are `KeyEvent` methods.

## Handling Mouse Events

Even though Java program users sometimes type characters from a keyboard, when you write GUI programs you probably expect users to spend most of their time operating a mouse. The **MouseMotionListener interface** provides you with methods named `mouseDragged()` and `mouseMoved()` that detect the mouse being rolled or dragged across a component surface. The **MouseListener interface** provides you with methods named `mousePressed()`, `mouseClicked()`, and `mouseReleased()` that are analogous to the keyboard event methods `keyPressed()`, `keyTyped()`, and `keyReleased()`. With a mouse, however, you are interested in more than its button presses; you sometimes simply want to know where a mouse is pointing. The additional interface methods `mouseEntered()` and `mouseExited()` inform you when the user positions the mouse over a component (entered) or moves the mouse off a component (exited). The **MouseListener interface** implements all the methods in both the `MouseListener` and `MouseMotionListener` interfaces; although it has no methods of its own, it is a convenience when you want to handle many different types of mouse events. Tables 15-6 and 15-7 show the methods of the `MouseListener` and `MouseMotionListener` classes, respectively.

Method	Description
<code>void mouseClicked(MouseEvent e)</code>	Invoked when the mouse button has been clicked (pressed and released) on a component
<code>void mouseEntered(MouseEvent e)</code>	Invoked when the mouse pointer enters a component
<code>void mouseExited(MouseEvent e)</code>	Invoked when the mouse pointer exits a component
<code>void mousePressed(MouseEvent e)</code>	Invoked when a mouse button has been pressed on a component
<code>void mouseReleased(MouseEvent e)</code>	Invoked when a mouse button has been released on a component

**Table 15-6** MouseListener methods



Many of the methods in Tables 15-6 and 15-7 also appear in tables earlier in this chapter. They are organized by interface here so you can better understand the scope of methods that are available for mouse actions. Don't forget that because `MouseListener`, `MouseMotionListener`, and `MouseListener` are interfaces, you must include each method in every program that implements them, even if you choose to place no instructions within some of the methods.

Method	Description
<code>void mouseDragged(MouseEvent e)</code>	Invoked when a mouse button is pressed on a component and then dragged
<code>void mouseMoved(MouseEvent e)</code>	Invoked when the mouse pointer has been moved onto a component but no buttons have been pressed

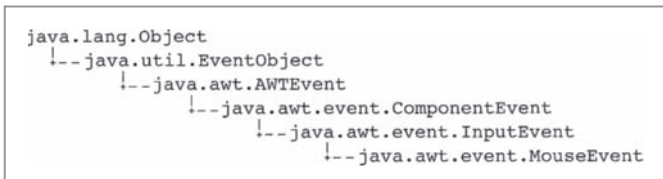
**Table 15-7** MouseMotionListener methods



The `MouseWheelListener` interface contains just one method named `mouseWheelMoved()`, and it accepts a `MouseWheelEvent` argument.

734

Each of the methods in Tables 15-6 and 15-7 accepts a `MouseEvent` argument. A **MouseEvent** is the type of event generated by mouse manipulation. Figure 15-28 shows the inheritance hierarchy of the `MouseEvent` class. From this diagram, you can see that a `MouseEvent` is a type of `InputEvent`, which is a type of `ComponentEvent`. The `MouseEvent` class contains many instance methods and fields that are useful in describing mouse-generated events. Table 15-8 lists some of the more useful methods of the `MouseEvent` class, and Table 15-9 lists some fields.



**Figure 15-28** The inheritance hierarchy of the `MouseEvent` class

Method	Description
<code>int getButton()</code>	Returns which, if any, of the mouse buttons has changed state; uses fields <code>NOBUTTON</code> , <code>BUTTON1</code> , <code>BUTTON2</code> , and <code>BUTTON3</code>
<code>int getClickCount()</code>	Returns the number of mouse clicks associated with the current event
<code>int getX()</code>	Returns the horizontal x-position of the event relative to the source component
<code>int getY()</code>	Returns the vertical y-position of the event relative to the source component

**Table 15-8** Some useful `MouseEvent` methods



Field	Description
<code>static int BUTTON1</code>	Indicates mouse button #1; used by <code>getButton()</code>
<code>static int BUTTON2</code>	Indicates mouse button #2; used by <code>getButton()</code>
<code>static int BUTTON3</code>	Indicates mouse button #3; used by <code>getButton()</code>
<code>static int NOBUTTON</code>	Indicates no mouse buttons; used by <code>getButton()</code>
<code>static int MOUSE_CLICKED</code>	The “mouse clicked” event
<code>static int MOUSE_DRAGGED</code>	The “mouse dragged” event
<code>static int MOUSE_ENTERED</code>	The “mouse entered” event
<code>static int MOUSE_EXITED</code>	The “mouse exited” event

**Table 15-9** Some useful `MouseEvent` fields

Figure 15-29 shows a `JMouseActionFrame` application that demonstrates several of the mouse listener and event methods. `JMouseActionFrame` extends `JFrame`, and because it implements the `MouseListener` interface, it must include all five methods—`mouseClicked()`, `mouseEntered()`, `mouseExited()`, `mousePressed()`, and `mouseReleased()`—even though no actions are included in the `mousePressed()` or `mouseReleased()` methods.

```
import javax.swing.*;
import java.awt.*;
import java.awt.event.*;
public class JMouseActionFrame extends JFrame implements MouseListener
{
    private int x, y;
    private JLabel label = new JLabel("Do something with the mouse");
    String msg = "";

    public JMouseActionFrame()
    {
        setTitle("Mouse Actions");
        setDefaultCloseOperation(JFrame.EXIT_ON_CLOSE);
        setLayout(new FlowLayout());
        addMouseListener(this);
        add(label);
    }
}
```

**Figure 15-29** The `JMouseActionFrame` application (*continues*)

*(continued)*

```
public void mouseClicked(MouseEvent e)
{
    int whichButton = e.getButton();
    msg = "You pressed mouse ";
    if(whichButton == MouseEvent.BUTTON1)
        msg += "button 1.";
    else
        if(whichButton == MouseEvent.BUTTON2)
            msg += "button 2.";
        else
            msg += "button 3.";
    msg += " You are at position " +
        e.getX() + ", " + e.getY() + ".";
    if(e.getClickCount() == 2)
        msg += " You double-clicked.";
    else
        msg += " You single-clicked.";
    label.setText(msg);
}

public void mouseEntered(MouseEvent e)
{
    msg = "You entered the frame.";
    label.setText(msg);
}

public void mouseExited(MouseEvent e)
{
    msg = "You exited the frame.";
    label.setText(msg);
}

public void mousePressed(MouseEvent e)
{
}

public void mouseReleased(MouseEvent e)
{
}

public static void main(String[] args)
{
    JMouseActionFrame mFrame = new JMouseActionFrame();
    final int WIDTH = 750;
    final int HEIGHT = 300;
    mFrame.setSize(WIDTH, HEIGHT);
    mFrame.setVisible(true);
}
}
```

**Figure 15-29** The JMouseActionFrame application

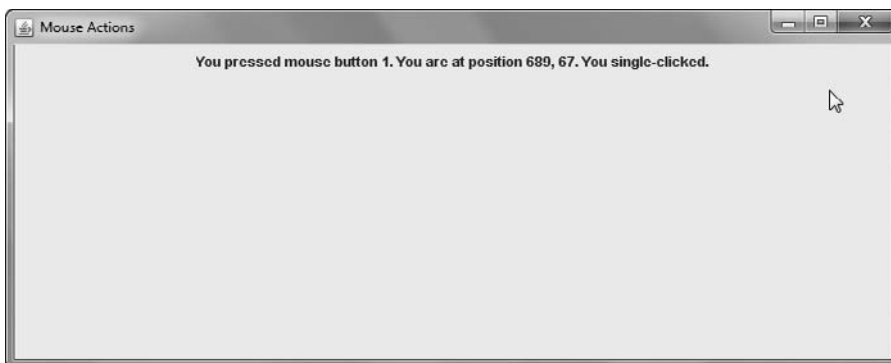
The `JMouseEventFrame` application in Figure 15-29 displays messages as the user generates mouse actions. At the start of the class, two integers are declared to hold the mouse position  $x$ - and  $y$ -coordinates. A `JLabel` and a `String` are also declared to hold messages that inform the user of the mouse actions taken. In the shaded section of Figure 15-29, the constructor sets a frame title by passing it to the parent of `JMouseEventFrame`, sets a close operation, sets the layout manager, enables the frame to listen for mouse events, and adds the `JLabel` to the `JFrame`.

In Figure 15-29, most of the action occurs in the `mouseClicked()` method (the second unshaded area in the figure). The method builds a `String` that is ultimately assigned to the `JLabel`. The same actions could have been placed in the `mousePressed()` or `mouseReleased()` method because the statements could be placed in the frame just as well at either of those times. Within the `mouseClicked()` method, the `MouseEvent` object named `e` is used several times. It is used with the `getButton()` method to determine which mouse button the user clicked, then used with `getX()` and `getY()` to retrieve the mouse position, and then used with `getClickCount()` to distinguish between single- and double-clicks.

In Figure 15-29, different messages also are generated in the `mouseEntered()` and `mouseExited()` methods, so the user is notified when the mouse pointer has “entered”—that is, passed over the surface area of—the `JFrame`, the component that is listening for actions.

The `main()` method at the end of the class creates one instance of the `JMouseEventFrame` class and sets its size and visibility.

Figure 15-30 shows the `JMouseEventFrame` application during execution. At this point, the user has just clicked the left mouse button near the upper-right corner of the frame. Of course, in your own applications you might not want only to notify users of their mouse actions; instead, you might want to perform calculations, create files, or generate any other programming tasks.



**Figure 15-30** Typical execution of the `JMouseEventFrame` application

## TWO TRUTHS & A LIE

### Handling Mouse Events

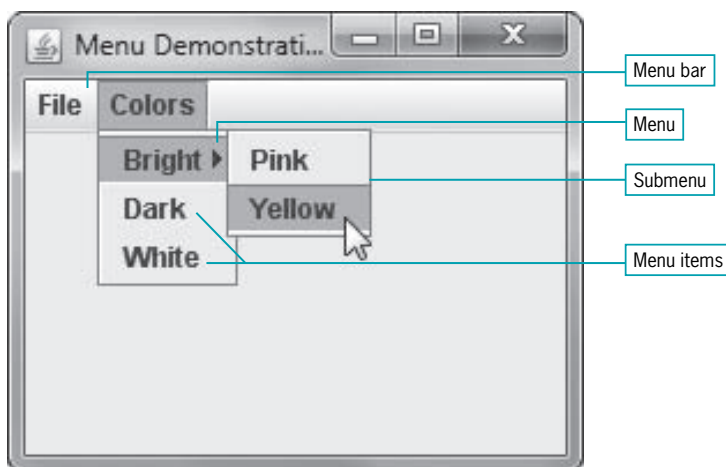
1. The `MouseMotionListener` interface provides you with methods that detect the mouse being rolled or dragged across a component surface.
2. The `MouseListener` interface provides you with methods that are analogous to the keyboard event methods `keyPressed()`, `keyTyped()`, and `keyReleased()`.
3. The `MouseListener` interface implements all the methods in the `MouseListener` interface.

The false statement is #3. The `MouseListener` interface implements all the methods in both the `MouseListener` and `MouseMotionListener` interfaces.

## Using Menus

**Menus** are lists of user options; they are commonly added features in GUI programs. Application users are accustomed to seeing horizontal menu bars across the tops of frames, and they expect to be able to click those options to produce drop-down lists that display more choices. The horizontal list of `JMenus` is a `JMenuBar`. Each `JMenu` can contain options, called `JMenuItems`, or can contain submenus that also are `JMenus`. For example, Figure 15-31 shows a `JFrame` that illustrates the use of the following components:

- A `JMenuBar` that contains two `JMenu`s named `File` and `Colors`.
- Three items within the `Colors` `JMenu`: `Bright`, `Dark`, and `White`. `Dark` and `White` are `JMenuItems`. `Bright` is a `JMenu` that holds a submenu. You can tell that `Bright` is a submenu because an arrow sits to the right of its name, and when the mouse hovers over `Bright`, two additional `JMenuItems` appear: `Pink` and `Yellow`.



**Figure 15-31** A `JFrame` with a horizontal `JMenuBar` that holds two `JMenus`

To create the output shown in Figure 15-31, a series of `JMenuBar`, `JMenu`, and `JMenuItem` objects were created and put together in stages. You can create each of the components you see in the menus in Figure 15-31 as follows:

- You can create a `JMenuBar` much like other objects—by using the `new` operator and a call to the constructor, as follows:

```
JMenuBar mainBar = new JMenuBar();
```

- You can create the two `JMenus` that are part of the `JMenuBar`:

```
JMenu menu1 = new JMenu("File");  
JMenu menu2 = new JMenu("Colors");
```

- The three components within the `Colors` `JMenu` are created as follows:

```
JMenu bright = new JMenu("Bright");  
JMenuItem dark = new JMenuItem("Dark");  
JMenuItem white = new JMenuItem("White");
```

- The two `JMenuItems` that are part of the `Bright` `JMenu` are created as follows:

```
JMenuItem pink = new JMenuItem("Pink");  
JMenuItem yellow = new JMenuItem("Yellow");
```

Once all the components are created, you assemble them.

- You add the `JMenuBar` to a `JFrame` using the `setJMenuBar()` method as follows:

```
setJMenuBar(mainBar);
```

Using the `setJMenuBar()` method assures that the menu bar is anchored to the top of the frame and looks like a conventional menu bar. Notice that the `JMenuBar` is not added to a `JFrame`'s content pane; it is added to the `JFrame` itself.

- The `JMenus` are added to the `JMenuBar` using the `add()` method. For example:

```
mainBar.add(menu1);  
mainBar.add(menu2);
```

- A submenu and two `JMenuItems` are added to the `Colors` menu as follows:

```
menu2.add(bright);  
menu2.add(dark);  
menu2.add(white);
```

- A submenu can contain its own `JMenuItems`. For example, the `Bright` `JMenu` that is part of the `Colors` menu in Figure 15-31 contains its own two `JMenuItem` objects:

```
bright.add(pink);  
bright.add(yellow);
```

Figure 15-32 shows a complete working program that creates a frame with a greeting and the `JMenu` shown in Figure 15-31.

```
import javax.swing.*;
import java.awt.*;
import java.awt.event.*;
import java.awt.Color;
public class JMenuFrame extends JFrame implements
    ActionListener
{
    private JMenuBar mainBar = new JMenuBar();
    private JMenu menu1 = new JMenu("File");
    private JMenu menu2 = new JMenu("Colors");
    private JMenuItem exit = new JMenuItem("Exit");
    private JMenu bright = new JMenu("Bright");
    private JMenuItem dark = new JMenuItem("Dark");
    private JMenuItem white = new JMenuItem("White");
    private JMenuItem pink = new JMenuItem("Pink");
    private JMenuItem yellow = new JMenuItem("Yellow");
    private JLabel label = new JLabel("Hello");
    public JMenuFrame()
    {
        setTitle("Menu Demonstration");
        setDefaultCloseOperation(JFrame.EXIT_ON_CLOSE);
        setLayout(new FlowLayout());
        setJMenuBar(mainBar);
        mainBar.add(menu1);
        mainBar.add(menu2);
        menu1.add(exit);
        menu2.add(bright);
        menu2.add(dark);
        menu2.add(white);
        bright.add(pink);
        bright.add(yellow);
        exit.addActionListener(this);
        dark.addActionListener(this);
        white.addActionListener(this);
        pink.addActionListener(this);
        yellow.addActionListener(this);
        add(label);
        label.setFont(new Font("Arial", Font.BOLD, 26));
    }
    public void actionPerformed(ActionEvent e)
    {
        Object source = e.getSource();
        Container con = getContentPane();
        if(source == exit)
            System.exit(0);
        else if(source == dark)
            con.setBackground(Color.BLACK);
        else if(source == white)
            con.setBackground(Color.WHITE);
        else if(source == pink)
            con.setBackground(Color.PINK);
        else con.setBackground(Color.YELLOW);
    }
}
```

Figure 15-32 The JMenuFrame class (continues)

(continued)

```
public static void main(String[] args)
{
    JMenuFrame mFrame = new JMenuFrame();
    final int WIDTH = 250;
    final int HEIGHT = 200;
    mFrame.setSize(WIDTH, HEIGHT);
    mFrame.setVisible(true);
}
}
```

741

**Figure 15-32** The JMenuFrame class

In the application in Figure 15-32, each JMenuItem becomes a source for an `ActionEvent`, and the `JFrame` is assigned the role of listener for each. The `actionPerformed()` method determines the source of any generated event. If the user selects the Exit option from the File menu, the application ends. If the user selects any of the colors from the Colors menu, the background color of the `JFrame` is altered accordingly.

## Using JCheckBoxMenuItem and JRadioButtonMenuItem Objects

The `JCheckBoxMenuItem` and `JRadioButtonMenuItem` classes derive from the `JMenuItem` class. Each provides more specific menu items as follows:

- `JCheckBoxMenuItem` objects appear with a check box next to them. An item can be selected (displaying a check mark in the box) or not. Usually, you use check box items to turn options on or off.
- `JRadioButtonMenuItem` objects appear with a round radio button next to them. Users usually expect radio buttons to be mutually exclusive, so you usually make radio buttons part of a `ButtonGroup`. Then, when any radio button is selected, the others are all deselected.

The state of a `JCheckBoxMenuItem` or `JRadioButtonMenuItem` can be determined with the `isSelected()` method, and you can alter the state of the check box with the `setSelected()` method.

Figure 15-33 shows a `JMenuFrame2` application in which two `JCheckBoxMenuItem`s and three `JRadioButtonMenuItem`s have been added to a `JMenu`. The controls have not yet been assigned any tasks, but Figure 15-34 shows how the menu looks when the application executes.

```
import javax.swing.*;
import java.awt.*;
import java.awt.event.*;
public class JMenuFrame2 extends JFrame
{
    private JMenuBar mainBar = new JMenuBar();
    private JMenu menu1 = new JMenu("File");
    private JCheckBoxMenuItem check1 = new
        JCheckBoxMenuItem("Check box A");
    private JCheckBoxMenuItem check2 = new
        JCheckBoxMenuItem("Check box B");
    private JRadioButtonMenuItem radio1 = new
        JRadioButtonMenuItem("Radio option 1");
    private JRadioButtonMenuItem radio2 = new
        JRadioButtonMenuItem("Radio option 2");
    private JRadioButtonMenuItem radio3 = new
        JRadioButtonMenuItem("Radio option 3");
    private ButtonGroup group = new ButtonGroup();

    public JMenuFrame2()
    {
        setTitle("Menu Demonstration");
        setDefaultCloseOperation(JFrame.EXIT_ON_CLOSE);
        setLayout(new FlowLayout());
        setJMenuBar(mainBar);
        mainBar.add(menu1);
        menu1.add(check1);
        menu1.add(check2);
        menu1.addSeparator();
        menu1.add(radio1);
        menu1.add(radio2);
        menu1.add(radio3);
        group.add(radio1);
        group.add(radio2);
        group.add(radio3);
    }

    public static void main(String[] args)
    {
        JMenuFrame2 frame = new JMenuFrame2();
        final int WIDTH = 150;
        final int HEIGHT = 200;
        frame.setSize(WIDTH, HEIGHT);
        frame.setVisible(true);
    }
}
```

**Figure 15-33** The JMenuFrame2 application



## Using addSeparator()

The shaded statement in Figure 15-33 calls the `addSeparator()` method. This method adds a horizontal line to menus in order to visually separate groups for your users. In Figure 15-34, you can see that the separator falls between the `JCheckBoxMenuItem`s and the `JRadioButtonMenuItem`s because that's the order in which the shaded `addSeparator()` method call was made. The separator does not change the functionality of the menu; it simply makes the menu more visually organized for the user.

## Using setMnemonic()

A **mnemonic** is a key that causes an already visible menu item to be chosen. You can use the `setMnemonic()` method to provide a shortcut menu key for any visible menu item. For example, when you add the following statement to the `JMenuFrame2` constructor in Figure 15-33, the menu appears as in Figure 15-35:

```
menu1.setMnemonic('F');
```

The mnemonic for the File menu is set to 'F', so the *F* in *File* is underlined. When a user presses Alt+F on the keyboard, the result is the same as if the user had clicked File on the menu: the menu list is opened and displayed.



Your downloadable student files contain a `JMenuFrame3` application that includes the `setMnemonic()` instruction that produces the output in Figure 15-35.

You should use a different mnemonic for each menu item that has one; if you use the same mnemonic multiple times, only the first assignment works. Usually, you use the first letter of the option; for example, *F* for *File*. If multiple menu items start with the same letter, the convention is to choose the next most prominent letter in the name. For example, *x* is often chosen as the mnemonic for *Exit*.



**Figure 15-34** Execution of the `JMenuFrame2` application



**Figure 15-35** The File menu with a mnemonic applied

An **accelerator** is similar to a mnemonic. It is a key combination that causes a menu item to be chosen, whether it is visible or not. For example, many word-processing programs allow you to press Ctrl+P to print from anywhere in the program. Only **leaf menu items**—menus that do not bring up other menus—can have accelerators. (They are called “leaves” because they are at the end of a branch with no more branches extending from them.) See <http://java.sun.com> for more details.

## TWO TRUTHS & A LIE

### Using Menus

1. The horizontal list of JMenus at the top of a JFrame is a JMenu.
2. Each JMenu can contain options, called JMenuItemS, or can contain submenus that also are JMenus.
3. You add a JMenuBar to a JFrame using the setJMenuBar() method.

The false statement is #1. The horizontal list of JMenus at the top of a JFrame is a JMenuBar.

## You Do It

### Using BorderLayout

Using layout managers in the containers in your applications allows flexibility in arranging the components that users see on the screen. In this section, you will create a JFrame that uses a BorderLayout and place components in each region. In the following sections, you will observe how the same components appear when other layout managers are used.

#### To create a JFrame that uses BorderLayout with a button in each region:

1. Open a new file in your text editor, and then type the following first few lines of a program that demonstrates BorderLayout with five objects:

```
import javax.swing.*;
import java.awt.*;
public class JBorderLayout extends JFrame
{
```

2. Instantiate five JButton objects, each with a label that is the name of one of the regions used by BorderLayout:

```
private JButton nb = new JButton("North");
private JButton sb = new JButton("South");
private JButton eb = new JButton("East");
private JButton wb = new JButton("West");
private JButton cb = new JButton("Center");
```

- Write the constructor that sets the JFrame's layout manager and adds each of the five JButtons to the appropriate region. Also set the default close operation for the JFrame.

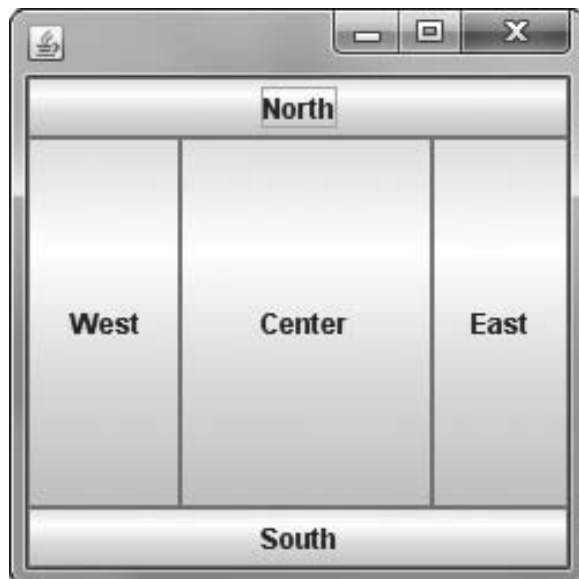
```
public JBorderLayout()
{
    setLayout(new BorderLayout());
    add(nb, BorderLayout.NORTH);
    add(sb, BorderLayout.SOUTH);
    add(eb, BorderLayout.EAST);
    add(wb, BorderLayout.WEST);
    add(cb, BorderLayout.CENTER);
    setDefaultCloseOperation(JFrame.EXIT_ON_CLOSE);
}
```

- Add a main() method that instantiates a JBorderLayout object and sets its size and visibility. Include a closing curly brace for the class:

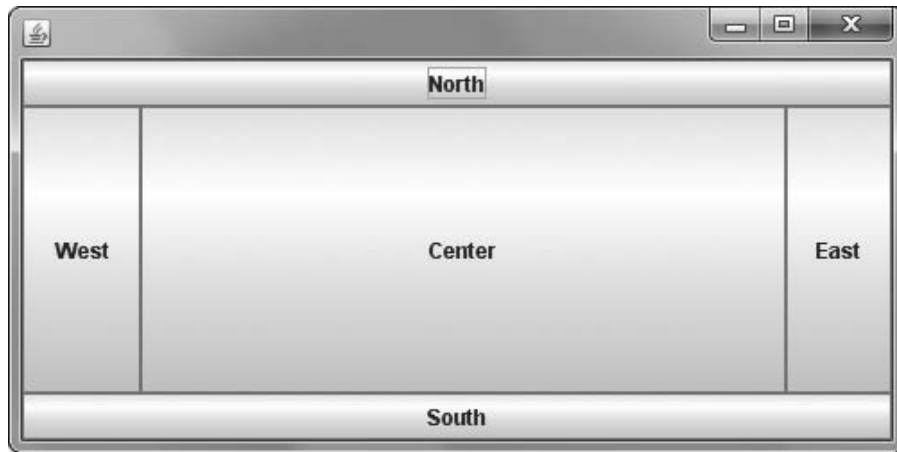
```
public static void main(String[] args)
{
    JBorderLayout jbl = new JBorderLayout();
    jbl.setSize(250, 250);
    jbl.setVisible(true);
}
}
```

- Save the file as **JBorderLayout.java**, then compile and execute it. The output looks like Figure 15-36. Each JButton entirely fills its region. (If you click the JButtons, they appear to be pressed, but because you have not implemented ActionListener, no other action is taken.)

- So you can observe the effects of changing the size of the viewing area, use your mouse to drag the right border of the JFrame to increase the width to approximately that shown in Figure 15-37. Notice that the center region expands, while the east and west regions retain their original size.



**Figure 15-36** Output of the JBorderLayout program



**Figure 15-37** Output of the `JBorderLayout` program after the user drags the right border to increase the width

7. Experiment with resizing both the width and height of the `JFrame`. Close the `JFrame` when you finish.

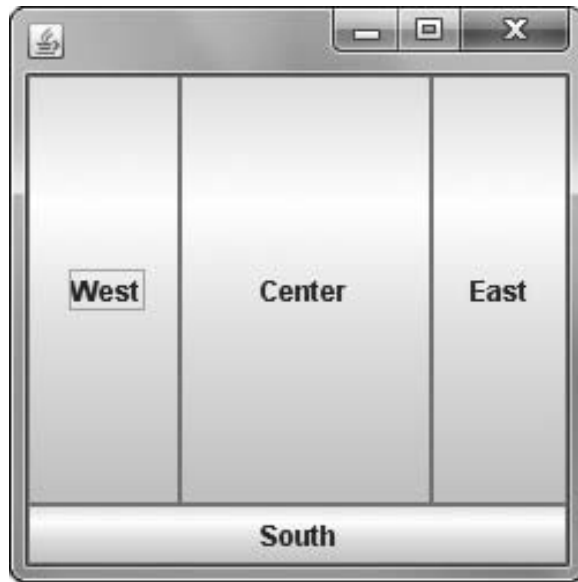
## Using Fewer than Five Components with the `BorderLayout` Manager

When you use `JBorderLayout`, you are not required to place components in every region. For example, you might use only four components, leaving the north region empty. Next, you will remove one of the objects from the `JBorderLayout` `JFrame` to observe the effect.

### To create a Container that uses `BorderLayout` with only four objects:

1. Open the `JBorderLayout.java` file in your text editor. Immediately save it as `JBorderLayoutNoNorth.java`.
2. Change the class name to `JBorderLayoutNoNorth`. Also change the constructor name and the two instances of the class name in the `main()` method.
3. Remove the declaration of the “North” button, and within the constructor, remove the statement that adds the “North” button to the `JFrame`.

4. Save the file and compile it, then run the program. The output appears as shown in Figure 15-38. The center region occupies the space formerly held by the north region.
5. Experiment with removing some of the other components from the `JBorderLayoutNoNorth` program.



**Figure 15-38** Output of the `JBorderLayoutNoNorth` program

## Using FlowLayout

Next, you will modify the `JBorderLayout` program to demonstrate how the same components appear when using `FlowLayout`.

### To demonstrate `FlowLayout`:

1. Open the `JBorderLayout.java` file in your text editor, and immediately save it as `JFlowLayoutRight.java`.
2. Change the class name from `JBorderLayout` to `JFlowLayoutRight`. Also change the constructor name and the references to the name in the `main()` method.
3. Within the constructor, change the `setLayout()` statement to use `FlowLayout` and right alignment:
 

```
setLayout(new FlowLayout(FlowLayout.RIGHT));
```
4. Alter each of the five `add()` statements so that just the button name appears within the parentheses and the region is omitted. For example, `add(nb, BorderLayout.NORTH);` becomes the following:
 

```
add(nb);
```

5. Save the file, then compile and execute it. Your output should look like Figure 15-39. The components have their “natural” size (or preferred size)—the minimum size the buttons need to display their labels. The buttons flow across the JFrame surface in a row until no more can fit; in Figure 15-39 the last two buttons added cannot fit in the first row, so they appear in the second row, right-aligned.
6. Experiment with widening and narrowing the JFrame, and observe how the components realign. Then close the JFrame.



**Figure 15-39** Output of the `JFlowLayoutRight` program

## Using GridLayout

Next, you will modify a JFrame to demonstrate GridLayout.

### To demonstrate GridLayout:

1. Open the `JFlowLayoutRight.java` file in your text editor, and save the file as `JGridLayout.java`.
2. Change the class name from `JFlowLayoutRight` to `JGridLayout`. Change the constructor name and the two references to the class in the `main()` method.
3. Within the constructor, change the `setLayout()` statement to establish a `GridLayout` with two rows, three columns, a horizontal space of two pixels, and a vertical space of four pixels:  

```
setLayout(new GridLayout(2, 3, 2, 4));
```

4. Save the file, then compile and execute it. The components are arranged in two rows and three columns from left to right across each row, in the order they were added to their container. Because there are only five components, one grid position still is available. See Figure 15-40.
5. Close the program.

## Using CardLayout

Next, you will create a `CardLayout` with five cards, each holding one of the `JButtons` used in the previous examples.

### To demonstrate `CardLayout`:

1. Open the `JGridLayout.java` file in your text editor, and save the file as `JCardLayout.java`.
2. Change the class name from `JGridLayout` to `JCardLayout`. Also change the constructor name and the two references in the `main()` method.
3. Within the constructor, change the `setLayout()` statement to establish a `CardLayout`:  
`setLayout(new CardLayout());`
4. Change the five `add()` statements that add the buttons to the content pane so that each includes a `String` that names the added component, as follows:

```
add("north", nb);
add("south", sb);
add("east", eb);
add("west", wb);
add("center", cb);
```



**Figure 15-40** Output of the `JGridLayout` program

5. Save the file, then compile and execute it. The output looks like Figure 15-41. You see only the “North” JButton because, as the first one added, it is the top card. You can click the button, but no actions take place because you have not implemented ActionListener.
6. Close the program.



**Figure 15-41** Output of the JCardLayout program

## Viewing All the Cards in CardLayout

Next, you will modify the JCardLayout program so that its buttons can initiate events that allow you to view all five JButtons you add to the content pane.

### To view all the cards in CardLayout:

1. Open the **JCardLayout.java** file in your text editor, and save the file as **JCardLayout2.java**.
2. Change the class name, constructor name, and two `main()` method references from **JCardLayout** to **JCardLayout2**.
3. At the top of the file, add the `import` statement that adds the classes and methods that allow the class to respond to events:
 

```
import java.awt.event.*;
```
4. At the end of the class header, insert the following phrase so the **JFrame** can respond to button clicks:
 

```
implements ActionListener
```
5. Instead of an anonymous layout manager, you need to create a **CardLayout** manager with an identifier that you can use with the `next()` method when the user clicks a button. Immediately after the five **JButton** declaration statements, insert the following statement:
 

```
CardLayout cardLayout = new CardLayout();
```
6. Within the constructor, change the `setLayout()` statement so it uses the named layout manager:
 

```
setLayout(cardLayout);
```



- At the end of the constructor, add five statements that allow each of the buttons to initiate an `ActionEvent`:

```
nb.addActionListener(this);
sb.addActionListener(this);
eb.addActionListener(this);
wb.addActionListener(this);
cb.addActionListener(this);
```

- After the constructor's closing curly brace, add an `actionPerformed()` method that responds to user clicks. The method uses the `next()` method to display the next card (next button) in the collection.

```
public void actionPerformed(ActionEvent e)
{
    cardLayout.next(getContentPane());
}
```

- Save, compile, and run the program. The output looks the same as in Figure 15-41: you see only the "North" `JButton`. However, when you click it, the button changes to "South", "East", "West", and "Center" in succession. Close the `JFrame` when you finish.

## Using a Menu Bar and `JPanels`

Next, you will create an application for a party planning company that uses a menu bar with multiple user options, and that uses separate `JPanels` with different layout managers to organize components.

### To create the `EventSelector` application:

- Open a new file in your text editor and enter the following first few lines of the `EventSelector` class. The class extends `JFrame` and implements `ActionListener` because the `JFrame` contains potential user mouse selections.

```
import javax.swing.*;
import java.awt.*;
import java.awt.event.*;
import java.awt.Color;
public class EventSelector extends JFrame implements ActionListener
{
```

- Create a `JMenuBar` and its two `JMenus` as follows:

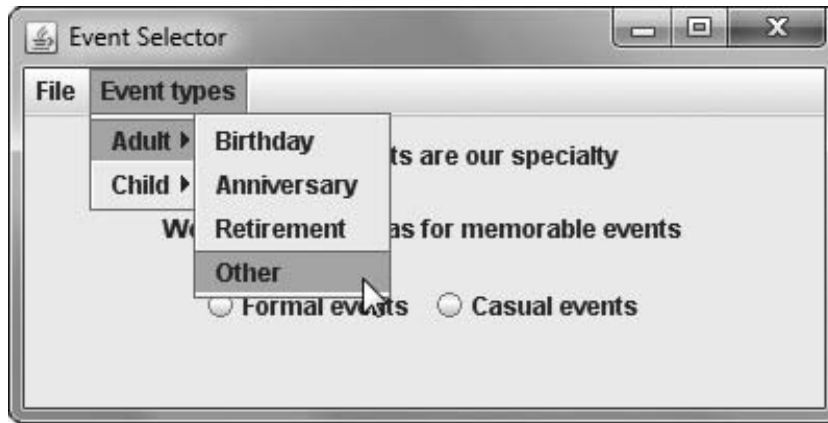
```
private JMenuBar mainBar = new JMenuBar();
private JMenu menu1 = new JMenu("File");
private JMenu menu2 = new JMenu("Event types");
```

- Next, create the items that will appear within the menus. The File menu contains an Exit option. The Event types menu contains two submenus: Adult and Child. Each of those submenus contains more options. For example, Figure 15-42 shows the expanded Adult event types menu in the finished program.

```

private JMenuItem exit = new JMenuItem("Exit");
private JMenu adult = new JMenu("Adult");
private JMenu child = new JMenu("Child");
private JMenuItem adultBirthday = new JMenuItem("Birthday");
private JMenuItem anniversary = new JMenuItem("Anniversary");
private JMenuItem retirement = new JMenuItem("Retirement");
private JMenuItem adultOther = new JMenuItem("Other");
private JMenuItem childBirthday = new JMenuItem("Birthday");
private JMenuItem childOther = new JMenuItem("Other");

```



**Figure 15-42** The Adult menu

4. Declare several other components that will be used to show how JFrames are composed:

```

private JPanel birthdayPanel = new JPanel();
private JPanel otherPanel = new JPanel();
private JLabel birthdayLabel = new
    JLabel("Birthday events are our specialty");
private JLabel otherLabel = new
    JLabel("We have lots of ideas for memorable events");
private JPanel buttonPanel = new JPanel();
private JRadioButton radioButton1 = new
    JRadioButton("Formal events");
private JRadioButton radioButton2 = new
    JRadioButton("Casual events");

```

5. Write the constructor for the JFrame. Set the title, the default close operation, and the layout. Call separate methods to compose the menu, to add the necessary action listeners to the menu items, and to lay out the JFrame's components. These tasks could be performed directly within the constructor, but you can place them in separate methods to better organize the application.

```
public EventSelector()
{
    setTitle("Event Selector");
    setDefaultCloseOperation(JFrame.EXIT_ON_CLOSE);
    setLayout(new FlowLayout());
    composeMenus();
    addActionListeners();
    layoutComponents();
}
```

6. Add the `composeMenus()` method. Set the main menu bar, and add two menus to it. Then add one option to the first menu and two submenus to the second menu. Finally, add four items to the first submenu and two items to the other one.

```
public void composeMenus()
{
    setJMenuBar(mainBar);
    mainBar.add(menu1);
    mainBar.add(menu2);
    menu1.add(exit);
    menu2.add(adult);
    menu2.add(child);
    adult.add(adultBirthday);
    adult.add(anniversary);
    adult.add(retirement);
    adult.add(adultOther);
    child.add(childBirthday);
    child.add(childOther);
}
```

7. Add the `addActionListeners()` method, which makes the `JFrame` become a listener for each menu item:

```
public void addActionListeners()
{
    exit.addActionListener(this);
    adultBirthday.addActionListener(this);
    anniversary.addActionListener(this);
    retirement.addActionListener(this);
    adultOther.addActionListener(this);
    childBirthday.addActionListener(this);
    childOther.addActionListener(this);
}
```

8. The `layoutComponents()` method arranges all the components that appear in the content pane. The `birthdayPanel` object contains a single label. The `otherPanel` object contains a label and another panel (`buttonPanel`) in a grid. The `buttonPanel` contains two radio buttons. For this demonstration, the radio buttons are not functional, but in a more complicated application, an `addActionListener()` method could be applied to them. Also, in a more complicated application, you could continue to place panels within another panel to achieve complex designs.

```

public void layoutComponents()
{
    birthdayPanel.setLayout(new FlowLayout());
    otherPanel.setLayout(new GridLayout(2, 1, 3, 3));
    birthdayPanel.add(birthdayLabel);
    otherPanel.add("other", otherLabel);
    otherPanel.add("buttons", buttonPanel);
    buttonPanel.add(radButton1);
    buttonPanel.add(radButton2);
    add(birthdayPanel);
    add(otherPanel);
}

```

9. Add an `actionPerformed()` method that responds to menu selections. Different background colors are set depending on the user's choices.

```

public void actionPerformed(ActionEvent e)
{
    Object source = e.getSource();
    Container con = getContentPane();
    if(source == exit)
        System.exit(0);
    else if(source == childBirthday || source == childOther)
        con.setBackground(Color.PINK);
    else
        con.setBackground(Color.WHITE);
    if(source == adultBirthday || source == childBirthday)
    {
        birthdayPanel.setBackground(Color.YELLOW);
        otherPanel.setBackground(Color.WHITE);
    }
    else
    {
        birthdayPanel.setBackground(Color.WHITE);
        otherPanel.setBackground(Color.YELLOW);
    }
}
}

```

10. Add the `main()` method, which instantiates an `EventSelector` object and sets its size and visibility. Add a closing curly brace for the class.

```

public static void main(String[] args)
{
    EventSelector frame = new EventSelector();
    final int WIDTH = 400;
    final int HEIGHT = 200;
    frame.setSize(WIDTH, HEIGHT);
    frame.setVisible(true);
}
}

```

11. Save the application as **EventSelector.java**, then compile and run it. Make various selections and observe the effects. Figure 15-43 shows the running application after the user has made some selections. Dismiss the frame.



**Figure 15-43** The EventSelector application

12. Experiment by making changes to the EventSelector application. For example, some menu selections could change the JFrame background to a different color, and others could add a new JLabel to the JFrame content pane.

## Don't Do It

- Don't forget that the content pane is operating behind the scenes when you use a top-level container and that, depending on the operations you want to perform, you might need to get a reference to it.
- Don't forget that when you create a custom Color object, 0 represents the darkest shade and 255 represents the lightest.
- Don't forget to set a layout manager if you do not want to use the default one for a container.
- Don't use add() to place a JFrame's menu bar. You must use the setMenuBar() method to place a menu bar correctly.
- Don't use the same mnemonic for multiple menu items.

## Key Terms

A **top-level container** is one at the top of a containment hierarchy. The Java top-level containers are `JFrame`, `JDialog`, and `JApplet`.

A **containment hierarchy** is a tree of components that has a top-level container as its root (that is, at its uppermost level).

A **content pane** contains all the visible components in a top-level container's user interface.

A **menu bar** is a horizontal strip that is placed at the top of a container and that contains user options.

A **glass pane** resides above the content pane in a container. It can contain tool tips.

The **`getContentPane()` method** returns a reference to a container's content pane.

The **`Color` class** defines colors for you to use in your applications.

The **`BorderLayout` manager** is the default manager class for all content panes. When you use the `BorderLayout` manager, the components fill the screen in five regions: north, south, east, west, and center.

The **`FlowLayout` manager** arranges components in rows across the width of a Container; when the current row is filled, additional Components are placed in new rows.

A Component's **`preferred size`** is its default size.

The **`GridLayout` manager** divides a container surface into a grid.

The **`CardLayout` manager** generates a stack of containers or components, one on top of another.

The **`GridBagLayout` manager** allows you to add Components to precise locations within the grid, as well as to indicate that specific Components should span multiple rows or columns within the grid.

The **`BoxLayout` manager** allows multiple components to be laid out either vertically or horizontally. The components do not wrap, so a vertical arrangement of components, for example, stays vertically arranged when the frame is resized.

A **`JPanel`** is a plain, borderless surface that can hold lightweight UI components.

**Double buffering** is the default buffering strategy in which `JPanels` are drawn off screen when they are updated and displayed only when complete.

The **primary surface** is the visible screen surface during double buffering.

The **back buffer** is the off-screen image during double buffering.

A **block line transfer**, or **blitting**, is the act of copying the contents from one surface to another.

A **JScrollPane** provides scroll bars along the side or bottom of a pane, or both, so that the user can scroll initially invisible parts of the pane into view.

The **viewport** is the viewable area in a `JScrollPane`.

An **adapter class** implements all the methods in an interface, providing an empty body for each method.

The **KeyListener interface** contains methods that react to actions the user initiates from the keyboard.

An **action key** is a keyboard key that does not generate a character.

**Virtual key codes** represent keyboard keys that have been pressed.

The **x-axis** is an imaginary horizontal line that indicates screen position.

The **y-axis** is an imaginary vertical line that indicates screen position.

The **x-coordinate** is a value that increases as you travel from left to right across a window.

The **y-coordinate** is a value that increases as you travel from top to bottom across a window.

The **MouseEvent interface** provides you with methods named `mouseDragged()` and `mouseMoved()` that detect the mouse being rolled or dragged across a component surface.

The **MouseListener interface** provides you with methods named `mousePressed()`, `mouseClicked()`, and `mouseReleased()` that are analogous to the keyboard event methods `keyPressed()`, `keyTyped()`, and `keyReleased()`.

The **MouseInputListener interface** implements all the methods in both the `MouseListener` and `MouseEvent` interfaces.

A **MouseEvent** is the type of event generated by mouse manipulation.

**Menus** are lists of user options.

A **mnemonic** is a key that causes an already visible menu item to be chosen.

An **accelerator** is a key combination that causes a menu item to be chosen, whether or not the menu item is visible.

A **leaf menu item** is a menu item that does not bring up another menu.

## Chapter Summary

- Every top-level container has a content pane that contains all the visible components in the container's user interface. The content pane can contain components and other containers. Whenever you create a top-level container, you can get a reference to its content pane using the `getContentPane()` method.
- The `Color` class defines 13 colors for you to use in your applications. It can be used with the `setBackground()` and `setForeground()` methods of the `Component` class to

make your applications more attractive and interesting. You also can create more than 16 million custom colors.

- A layout manager is an object that controls the size and position of components inside a `Container` object. The layout manager that you assign to the `Container` determines how the components are sized and positioned within it. The `BorderLayout` manager is the default manager class for all content panes; when you use it, the components fill the screen in five regions: north, south, east, west, and center. The `FlowLayout` manager arranges components in rows across the width of a `Container`. When you create a `GridLayout` object, you indicate the numbers of rows and columns you want, and then the container surface is divided into a grid. The `CardLayout` manager generates a stack of containers or components, one on top of another.
- A `JPanel` is a plain, borderless surface that can hold lightweight UI components.
- A `JScrollPane` provides scroll bars along the side or bottom of a pane, or both, so that the user can scroll initially invisible parts of the pane into view.
- The parent class for all event objects is named `EventObject`. `ActionEvents` are generated by components that users can click, such as `JButtons` and `JCheckBoxes`, and `TextEvents` are generated by components into which the user enters text, such as a `JTextField`. `MouseEvents` include determining the location of the mouse pointer and distinguishing between a single- and double-click. When you want to listen for an event, you implement an appropriate interface for your class. For every event class, such as `<name>Event`, there is a similarly named `<name>Listener` interface. Instead of implementing a listener class, you can extend an adapter class. An adapter class implements all the methods in an interface, providing an empty body for each method.
- In addition to the handler methods included with the event listener interfaces, the `AWTEvent` classes themselves contain methods that return information about an event.
- The `MouseListener` interface provides you with methods named `mouseDragged()` and `mouseMoved()` that detect the mouse being rolled or dragged across a component surface. The `MouseListener` interface provides you with methods named `mousePressed()`, `mouseClicked()`, and `mouseReleased()`. The additional interface methods `mouseEntered()` and `mouseExited()` inform you when the user positions the mouse over a component (entered) or moves the mouse off a component (exited). The `MouseEvent` interface implements all the methods in both the `MouseListener` and `MouseMotionListener` interfaces.
- Menus are lists of user options. You use `JMenuBar`, `JMenu`, `JMenuItem`, and other classes in menu creation.



## Review Questions

1. If you add fewer than five components to a `BorderLayout`, \_\_\_\_\_.
  - a. any empty component regions disappear
  - b. the remaining components expand to fill the available space
  - c. both a and b
  - d. none of the above
2. When you resize a `Container` that uses `BorderLayout`, \_\_\_\_\_.
  - a. the `Container` and the regions both change in size
  - b. the `Container` changes in size, but the regions retain their original sizes
  - c. the `Container` retains its size, but the regions change or might disappear
  - d. nothing happens
3. When you create a `JFrame` named `myFrame`, you can set its layout manager to `BorderLayout` with the statement \_\_\_\_\_.
  - a. `myFrame.setLayout = new BorderLayout();`
  - b. `myFrame.setLayout(new BorderLayout());`
  - c. `setLayout(myFrame = new BorderLayout());`
  - d. `setLayout(BorderLayout(myFrame));`
4. Which of the following is the correct syntax for adding a `JButton` named `b1` to a `Container` named `con` when using `CardLayout`?
  - a. `con.add(b1);`
  - b. `con.add("b1");`
  - c. `con.add("Options", b1);`
  - d. none of the above
5. You can use the \_\_\_\_\_ class to arrange components in a single row or column of a container.
  - a. `FlowLayout`
  - b. `BorderLayout`
  - c. `CardLayout`
  - d. `BoxLayout`
6. When you use \_\_\_\_\_, the components you add fill their region; they do not retain their default size.
  - a. `FlowLayout`
  - b. `BorderLayout`
  - c. `FixedLayout`
  - d. `RegionLayout`
7. The statement \_\_\_\_\_ ensures that components are placed from left to right across a `JFrame` surface until the first row is full, at which point a second row is started at the frame surface's left edge.
  - a. `setLayout(FlowLayout.LEFT);`
  - b. `setLayout(new FlowLayout(LEFT));`
  - c. `setLayout(new FlowLayout(FlowLayout.LEFT));`
  - d. `setLayout(FlowLayout(FlowLayout.LEFT));`

8. The `GridBagLayout` class allows you to \_\_\_\_\_.
  - a. add components to precise locations within the grid
  - b. indicate that specific components should span multiple rows or columns within the grid
  - c. both a and b
  - d. none of the above
9. The statement `setLayout(new GridLayout(2,7));` establishes a `GridLayout` with \_\_\_\_\_ horizontal row(s).
  - a. zero
  - b. one
  - c. two
  - d. seven
10. As you add new components to a `GridLayout`, \_\_\_\_\_.
  - a. they are positioned left to right across each row in sequence
  - b. you can specify exact positions by skipping some positions
  - c. both of the above
  - d. none of the above
11. A `JPanel` is a \_\_\_\_\_.
  - a. `Window`
  - b. `Container`
  - c. both of the above
  - d. none of the above
12. The \_\_\_\_\_ class allows you to arrange components as if they are stacked like index or playing cards.
  - a. `GameLayout`
  - b. `CardLayout`
  - c. `BoxLayout`
  - d. `GridBagLayout`
13. `AWTEvent` is the child class of \_\_\_\_\_.
  - a. `EventObject`
  - b. `Event`
  - c. `ComponentEvent`
  - d. `ItemEvent`
14. When a user clicks a `JPanel` or `JFrame`, the action generates a(n) \_\_\_\_\_.
  - a. `ActionEvent`
  - b. `MouseEvent`
  - c. `PanelEvent`
  - d. `KeyboardEvent`
15. Event handlers are \_\_\_\_\_.
  - a. abstract classes
  - b. concrete classes
  - c. listeners
  - d. methods
16. The return type of `getComponent()` is \_\_\_\_\_.
  - a. `Object`
  - b. `Component`
  - c. `int`
  - d. `void`

17. The `KeyEvent` method `getKeyChar()` returns a(n) \_\_\_\_\_.
- a. `int`
  - b. `char`
  - c. `KeyEvent`
  - d. `AWTEvent`
18. The `MouseEvent` method that allows you to identify double-clicks is \_\_\_\_\_.
- a. `getDouble()`
  - b. `isClickDouble()`
  - c. `getDoubleClick()`
  - d. `getClickCount()`
19. You can use the \_\_\_\_\_ method to determine the `Object` in which an `ActionEvent` originates.
- a. `getObject()`
  - b. `getEvent()`
  - c. `getOrigin()`
  - d. `getSource()`
20. Which of the following is true in a standard menu application?
- a. A `JMenuItem` holds a `JMenu`.
  - b. A `JMenuItem` holds a `JMenuBar`.
  - c. A `JMenuBar` holds a `JMenu`.
  - d. A `JMenu` holds a `JMenuBar`.

## Exercises

1. Create a `JFrame` and set the layout to `BorderLayout`. Place a `JButton` containing the name of a politician in each region (left, center, and right; or west, center, and east). Each politician's physical position should correspond to your opinion of his or her political stance. Save the file as **`JPoliticalFrame.java`**.
2. Create 26 `JButtons`, each labeled with a single, different letter of the alphabet. Create a `JFrame` to hold five `JPanels` in a five-by-one grid. Place six `JButtons` within each of the first four `JPanels` and two `JButtons` within the fifth `JPanel` of the `JFrame`. Add a `JLabel` to the fifth `JPanel`. When the user clicks a `JButton`, the text of the `JLabel` is set to "Folder X", where X is the letter of the alphabet that is clicked. Save the file as **`JFileCabinet.java`**.
3. Create a `JFrame` that holds four buttons with the names of four different fonts. Display a demonstration `JLabel` using the font that the user selects. Save the file as **`JFontFrame.java`**.
4. Create a `JFrame` that uses `BorderLayout`. Place a `JButton` in the center region. Each time the user clicks the `JButton`, change the background color in one of the other regions. Save the file as **`JColorFrame.java`**.
5. Create a `JFrame` with `JPanels`, a `JButton`, and a `JLabel`. When the user clicks the `JButton`, reposition the `JLabel` to a new location in a different `JPanel`. Save the file as **`JMovingFrame.java`**.
6. Create a class named `JPanelOptions` that extends `JPanel` and whose constructor accepts two colors and a `String`. Use the colors for background and foreground to display the `String`. Create an application named `JTeamColors` with `GridLayout`. Display four `JPanelOptions` `JPanels` that show the names, in their team colors, of

- four of your favorite sports teams. Save the files as **JPanelOptions.java** and **JTeamColors.java**.
7. Write an application that lets you determine the integer value returned by the `InputEvent` method `getModifiers()` when you click your left, right, or—if you have one—middle mouse button on a `JFrame`. Save the file as **JLeftOrRight.java**.
  8.
    - a. Search the Java Web site at <http://java.sun.com> for information on how to use a `JTextArea`. Write an application for the WebBuy Company that allows a user to compose the three parts of a complete e-mail message: the “To:”, “Subject:”, and “Message:” text. The “To:” and “Subject:” text areas should provide a single line for data entry. The “Message:” area should allow multiple lines of input and be able to scroll if necessary to accommodate a long message. The user clicks a button to send the e-mail message. When the message is complete and the Send button is clicked, the application should display “Mail has been sent!” on a new line in the message area. Save the file as **JEMail.java**.
    - b. Modify the `JEMail` application to include a Clear button that the user can click at any time to clear the “To:”, “Subject:”, and “Message:” fields. Save the file as **JEMail2.java**.
  9.
    - a. Create an application that uses a graphic interface to capture appointment data for a salesperson and writes that data to a random access output file. The data required for each appointment includes the client’s name, the day of the month, and the hour. For simplicity, this application accepts dates for the current month only, so the day field is an integer. Assume that only one appointment can be scheduled for a day, so that the day can be the key field. Allow the user to enter data one record at a time and to click a button to save it. Save the class as **CreateRandomDateFile.java**. Figure 15-44 shows the input screen into which the user has typed data for the first record.



**Figure 15-44** Data entry screen for the `CreateRandomDateFile` application

- b. Create an application that allows the user to enter a date and display the stored appointment for that date, if any. Save the file as **ReadRandomDateFile.java**.
10. Create a JFrame for the Summervale Resort. Allow the user to view information about different rooms available, dining options, and activities offered. Include at least two options in each menu and display appropriate information when the user makes a choice. Figure 15-45 shows a sample menu. Save the file as **SummervaleResort.java**.



**Figure 15-45** Typical execution of the SummervaleResort application



### Debugging Exercise

11. Each of the following files in the Chapter.15 folder of your downloadable student files has syntax and/or logic errors. In each case, determine the problem and fix the program. After you correct the errors, save each file using the same filename preceded with Fix. For example, DebugFifteen1.java will become FixDebugFifteen1.java.
- a. DebugFifteen1.java                      c. DebugFifteen3.java  
 b. DebugFifteen2.java                      d. DebugFifteen4.java



### Game Zone



As you create some of the games in this section, you might find it convenient to add or remove components in a container after construction. Recall from Chapter 14 that in order for the user to see your changes, you might need to call the `validate()`, `invalidate()`, and `repaint()` methods. You will learn more about the `repaint()` method in the next chapter, *Graphics*.

12. a. Create a Mine Field game in which the user attempts to click 10 panels of a grid before hitting the “bomb.” Set up a JFrame using BorderLayout, use the NORTH region for a congratulatory message, and use the CENTER region for the game. In the CENTER region, create a four-by-five grid using GridLayout and populate the

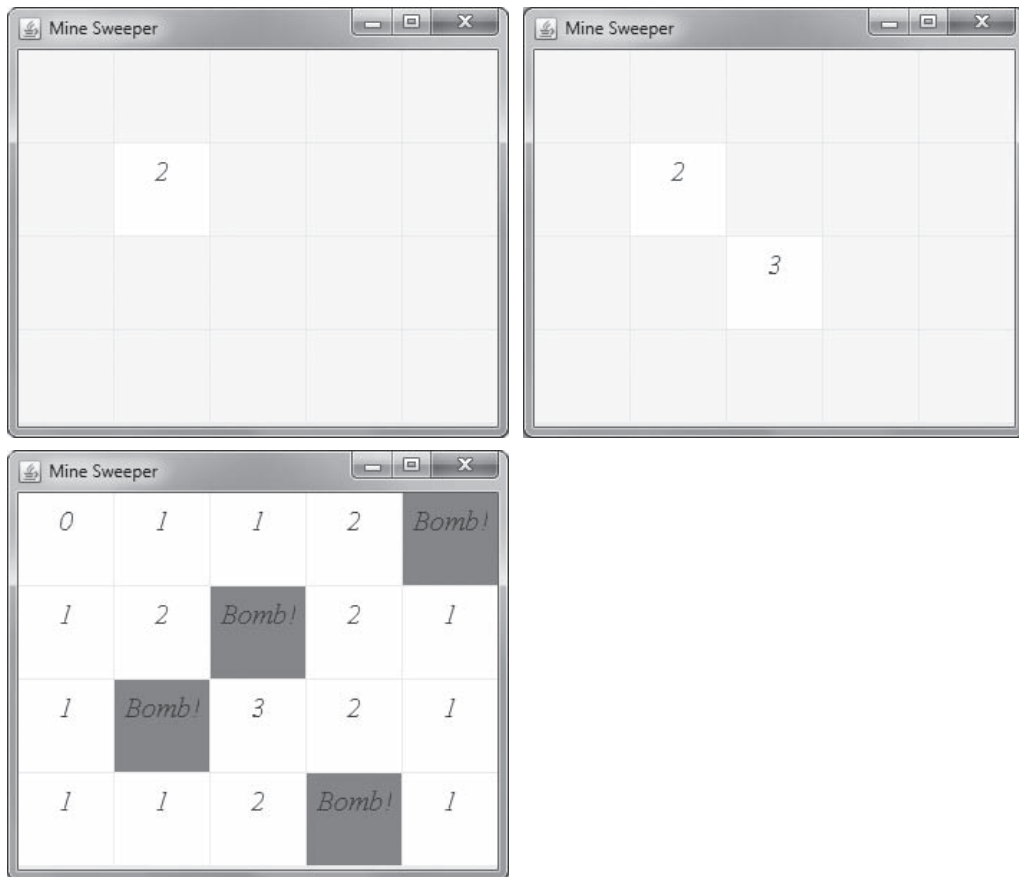
- grid with `JPanels`. Set the background color for all the `JPanels` to `Color.BLUE`. Randomly choose one of the panels to be the bomb; the other 19 panels are “safe.” Allow the player to click on grids. If the player chooses a safe panel, turn the panel to `Color.WHITE`. If the player chooses the bomb panel, turn the panel to `Color.RED` and turn all the remaining panels white. If the user successfully chooses 10 safe panels before choosing the bomb, display a congratulatory message in the NORTH `JFrame` region. Save the game as **MineField.java**.
- b. Improve the Mine Field game by allowing the user to choose a difficulty level before beginning. Place three buttons labeled “Easy”, “Intermediate”, and “Difficult” in one region of the `JFrame`, and place the game grid and congratulatory message in other regions. Require the user to select a difficulty level before starting the game, then disable the buttons. If the user chooses “Easy”, the user must select only five safe panels to win the game. If the user selects “Intermediate”, require 10 safe panels, as in the original game. If the user selects “Difficult”, require 15 safe panels. Save the game as **MineField2.java**.
13.
    - a. Create a game that helps new mouse users improve their hand-eye coordination. Within a `JFrame`, display an array of 48 `JPanels` in a `GridLayout` using eight rows and six columns. Randomly display an *X* on one of the panels. When the user clicks the correct panel (the one displaying the *X*), remove the *X* and display it on a different panel. After the user has successfully “hit” the correct panel 10 times, display a congratulatory message that includes the user’s percentage (hits divided by clicks). Save the file as **JCatchTheMouse.java**.
    - b. Review how to use the `GregorianCalendar` class from Chapter 4, then revise the `JCatchTheMouse` game to conclude by displaying the number of seconds it took the user to click all 10 *X*s. When the application starts, create a `GregorianCalendar` object and use the `get(Calendar.SECOND)` and `get(Calendar.MINUTE)` methods with it to get the `SECOND` and `MINUTE` values at the start of the game. When the user has clicked all 10 *X*s, create a second `GregorianCalendar` object and get the `SECOND` and `MINUTE` values at the end of the game. If the user starts and ends a game during the same minute, then the playing time is simply the difference between the two `SECOND` values. Make sure your application times the game correctly even if the start and stop times do not occur during the same `MINUTE`. Save the file as **JCatchTheMouseTimed.java**.
    - c. In the `JCatchTheMouseTimed` game described in Game Zone exercise 13b, the timer does not work correctly if the user happens to play when the hour, day, or year changes. Use <http://java.sun.com> to find out how to use the `GregorianCalendar` class method `getTimeInMillis()`, then modify the game to measure playing time accurately, no matter when the user plays the game. Save the file as **JCatchTheMouseTimed2.java**.



If you were writing a professional timed game, you would test the timer's accuracy regardless of when the user decided to play. For example, if the user played over the midnight hour on New Year's Eve, you would either have to test the game then (which is impractical), or reset your system's clock to simulate New Year's Eve. If you are writing the programs in this book on a school's computer network, you might be blocked by the administrator from changing the date and time. Even if you are working on your own computer, do not attempt to change the date and time unless you understand the impact on other installed applications. For example, your operating system might assume that an installed virus-protection program is expired, or a financial program might indicate that automatically paid bills are overdue.

14. The game *Corner the King* is played on a checkerboard. To begin, a checker is randomly placed in the bottom row. The player can move one or two squares to the left or upwards, then the computer can move one or two squares left or up. The first to reach the upper-left corner wins. Design a game in which the computer's moves are chosen randomly. When the game ends, display a message that indicates the winner. Save the game as **CornerTheKing.java**.
15. Create a target practice game that allows the user to click moving targets and displays the number of hits in a 10-second period. Create a grid of at least 100 `JPanels`. Randomly display an *X* on five panels to indicate targets. As the user clicks each *X*, change the label to indicate a hit. When all five *X*s have been hit, randomly display a new set of five targets. Continue with as many sets as the user can hit in 10 seconds. (Use <http://java.sun.com> to find how to use the `GregorianCalendar` class method `getTimeInMillis()` to calculate the time change.) When the time is up, display a count of the number of targets hit. Save the file as **JTargetPractice.java**.
16. You set up the card game *Concentration* by placing pairs of cards face down in a grid. The player turns up two cards at a time, exposing their values. If the cards match, they are removed from the grid. If the cards do not match, they are turned back over so their values are hidden again, and the player selects two more cards to expose. Using the knowledge gained by the previously exposed cards, the player attempts to remove all the pairs of cards from play. Create a Java version of this game using a `GridLayout` that is four rows high and five columns wide. Randomly assign two of the numbers 0 through 9 to each of 20 `JPanels`, and place each of the 20 `JPanels` in a cell of the grid. Initially, show only "backs" of cards by setting each panel's background to a solid color. When the user clicks a first card, change its color and expose its value. After the user clicks a second card, change its color to the same color as the first exposed card, expose the second card's value, and keep both cards exposed until the user's mouse pointer exits the second card. If the two exposed cards are different, hide the cards again. If the two turned cards match, then "remove" the pair from play by setting their background colors to white. When the user has matched all 20 cards into 10 pairs, display a congratulatory message. Save the game as **JConcentration.java**.
17. Create a *Mine Sweeper* game by setting up a grid of rows and columns in which "bombs" are randomly hidden. You choose the size and difficulty of the game; for example, you might choose to create a fairly simple game by displaying a four-by-five grid that contains four bombs. If a player clicks a panel in the grid that contains a

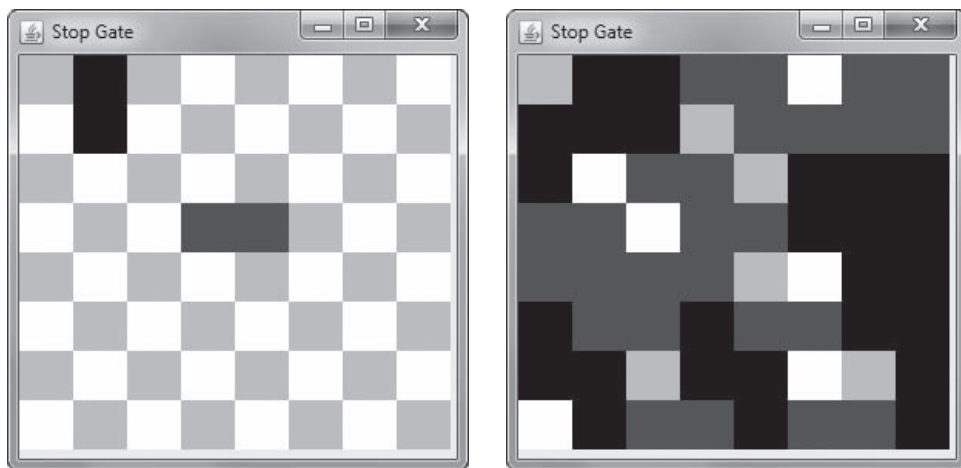
bomb, then the player loses the game. If the clicked panel is not a bomb, display a number that indicates how many adjacent panels contain a bomb. For example, if a user clicks a panel containing a 0, the user knows it is safe to click any panel above, below, beside, or diagonally adjacent to the cell, because those cells cannot possibly contain a bomb. If the player loses by clicking a bomb, display all the numeric values as well as the bomb positions. If the player succeeds in clicking all the panels except those containing bombs, the player wins and you should display a congratulatory message. Figure 15-46 shows the progression of a typical game. In the first screen, the user has clicked a panel, and the display indicates that two adjacent cells contain a bomb. In the second screen, the user has clicked a second panel, and the display indicates that three adjacent cells contain bombs. In the last screen, the user has clicked a bomb panel, and all the bomb positions are displayed. Save the game as **MineSweeper.java**.



**Figure 15-46** Typical progression of MineSweeper game



18. Create the game Lights Out using a `BorderLayout`. Place a five-by-five grid of panels in one region, and reserve another region for a congratulatory message. Randomly set each panel in the grid to a dark color or light color. The object of the game is to force all the panels to be dark, thus turning the “lights out.” When the player clicks a panel, turn all the panels in the same row and column, including the clicked panel, to the opposite color. For example, if the user clicks the panel in the second row, third column, then darken all the light-colored panels in the second row and third column, and lighten all the dark-colored panels in that row and column. When all the panels in the grid are dark, all the lights are out, so display a congratulatory message. Save the game as **LightsOut.java**.
19. The game StopGate is played on a checkerboard with a set of dominoes; each domino is large enough to cover two checkerboard squares. One player places a domino horizontally on the checkerboard, covering any two squares. The other player then places a domino vertically to cover any other two squares. When a player has no more moves available, that player loses. Create a computerized version of the game in which the player places the horizontal pieces and the computer randomly selects a position for the vertical pieces. (Game construction will be simpler if you allow the player to select only the left square of a two-square area and assume the domino covers that position plus the position immediately to the right.) Use a different color for the player’s dominoes and the computer’s dominoes. Display a message naming the winner when no more moves are possible. Figure 15-47 shows a typical game after the player and computer have each made one move, and near the end of the game when the player is about to win—the player has two moves remaining, but the computer has none. Save the file as **StopGate.java**.



**Figure 15-47** A typical game of StopGate just after play begins and near the end of the game

*This page intentionally left blank*

## Graphics

In this chapter, you will:

- ③ Learn about the `paint()` and `repaint()` methods
- ③ Use the `drawString()` method to draw `Strings` using various fonts and colors
- ③ Draw lines and shapes
- ③ Learn more about fonts
- ③ Draw with Java 2D graphics

## Learning About the `paint()` and `repaint()` Methods

When you run a Java program that contains graphics, such as the `JFrame` applications in the previous chapters, the display surface frequently must be redisplayed, or **rendered**.

Redisplaying a surface also is called **painting**. Painting operations fall into two broad categories based on what causes them:

- **System-triggered painting** operations occur when the system asks a component to render its contents. This happens when the component is first made visible, if it is resized, or if it is damaged. For example, a component becomes damaged when another component that previously covered part of it has been moved, revealing a portion that was not visible.
- **Application-triggered painting** operations occur when the internal state of a component has changed. For example, when a user clicks a button, a “pressed” version of the button must be rendered.

No matter which way a paint request is triggered, a `Component`’s **`paint()` method** is invoked. The header for the `paint()` method is:

```
public void paint(Graphics g)
```

The parameter to the method is a `Graphics` object. The **`Graphics` class** is an abstract class that descends directly from `Object` and holds data about graphics operations and methods for drawing shapes, text, and images. When AWT invokes the `paint()` method, the `Graphics` object parameter is preconfigured with the appropriate values for drawing on the component:

- The `Graphics` object’s *color* is set to the component’s foreground property.
- The `Graphics` object’s *font* is set to the component’s font property.
- The `Graphics` object’s *translation* is set such that the coordinates 0, 0 represent the upper-left corner of the component.
- The `Graphics` object’s *clip rectangle* is set to the area of the component that needs repainting.

Programs must use this `Graphics` object (or one derived from it) to render output. They can change the values of the `Graphics` object as necessary.

You override the `paint()` method in your programs when you want specific actions to take place when components must be rendered. You don’t usually call the `paint()` method directly. Instead, you call the **`repaint()` method**, which you can use when a window needs to be updated, such as when it contains new images or you have moved a new object onto the screen. The Java system calls the `repaint()` method when it needs to update a window, or you can call it yourself—in either case, `repaint()` creates a `Graphics` object for you that becomes the `paint()` method parameter. The `repaint()` method calls another method named `update()`, which clears its `Component`’s content pane and calls the `paint()` method. The series of events is best described with an example. Figure 16-1 shows a `JDemoPaint` class that extends `JFrame`. The frame contains a `JButton`. The constructor sets a title, layout manager, and default close operation, and it adds the button to the frame. The button is designated as a source for actions to which the frame can respond.

```
import javax.swing.*;
import java.awt.*;
import java.awt.event.*;
public class JDemoPaint extends JFrame implements ActionListener
{
    JButton pressButton = new JButton("Press");
    public JDemoPaint()
    {
        setTitle("Paint Demo");
        setLayout(new FlowLayout());
        setDefaultCloseOperation(JFrame.EXIT_ON_CLOSE);
        add(pressButton);
        pressButton.addActionListener(this);
    }
    public void actionPerformed(ActionEvent e)
    {
        System.out.print("Button pressed. ");
        repaint();
    }
    public void paint(Graphics g)
    {
        super.paint(g);
        System.out.println("In paint method.");
    }
    public static void main(String[] args)
    {
        JDemoPaint frame = new JDemoPaint();
        frame.setSize(150, 100);
        frame.setVisible(true);
    }
}
```

**Figure 16-1** The `JDemoPaint` class

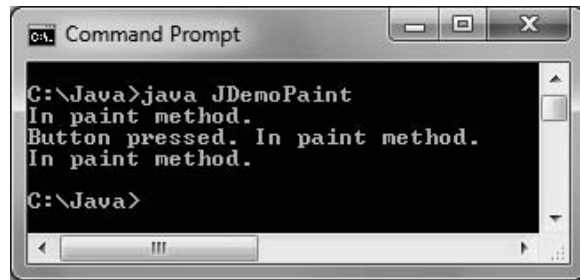


In Figure 16-1, the shaded first line of code in the `paint()` method is `super.paint(g)`. This statement is a call to the `paint()` method that is part of `JDemoPaint`'s parent class (`JFrame`), and it passes the local `Graphics` object (named `g`) to this method. Although this program and others in this chapter will work without this statement, omitting it causes errors in more complicated applications. For now, get in the habit of including this method call as the first statement in any `JFrame`'s `paint()` method, using whatever local name you have declared for your `paint()` method's `Graphics` argument.

In the `JDemoPaint` class in Figure 16-1, the `actionPerformed()` method executes when the user presses the `JButton`. The method contains a call to `repaint()`, which is unseen in the class and which automatically calls the `paint()` method.

The `paint()` method in the `JDemoPaint` class overrides the automatically supplied `paint()` method. The `paint()` method displays a line of output at the command line—it announces that the `paint()` method is executing. Figure 16-2 shows a typical execution of the program. The `JFrame` is first drawn when it is constructed, and the message *In paint method.* appears

at the command line. When the user clicks the button on the frame, two messages are displayed: *Button pressed.* from the `actionPerformed()` method, and *In paint method.* from the `paint()` method that is called by `repaint()`. When the user minimizes and restores the frame, `paint()` is called automatically, and the *In paint method.* message is displayed again.



```

C:\Java>java JDemoPaint
In paint method.
Button pressed. In paint method.
In paint method.
C:\Java>

```

**Figure 16-2** Typical execution of `JDemoPaint` program



If you call `repaint()` alone in a class that is a container, then the entire container is repainted. (The call to `repaint()` is actually `this.repaint()`;) Repainting the entire container might be unnecessary and waste time if only part of the container has changed. If you call `repaint()` with a component, as in `pressButton.repaint()`, then only that component is repainted.



The `repaint()` method only requests that Java repaint the screen. If a second request to `repaint()` occurs before Java can carry out the first request, Java executes only the last `repaint()` method.



Before the built-in `paint()` method is called, the entire container is filled with its background color. Then the `paint()` method redraws the contents. The effect is that components are “erased” before being redrawn.

## Using the `setLocation()` Method

The **`setLocation()` method** allows you to place a component at a specific location within a `JFrame`’s content pane. In Chapter 15, you learned that a window or frame consists of a number of pixels on the screen, and that any component you place on the screen has a horizontal, or *x*-axis, position as well as a vertical, or *y*-axis, position. When you allow a layout manager to position components, specific positions are selected automatically for each component.

You can change the position of a component by using the `setLocation()` method and passing it *x*- and *y*-coordinate positions. For example, to position a `JLabel` object named `someLabel` at the upper-left corner of a `JFrame`, you write the following within the `JFrame` class:

```
someLabel.setLocation(0, 0);
```

If a window is 200 pixels wide by 100 pixels tall, you can place a `Button` named `pressMe` in the approximate center of the window with the following statement:

```
pressMe.setLocation(100, 50);
```

The coordinate arguments can be numeric constants or variables.

When you use `setLocation()`, the upper-left corner of the component is placed at the specified *x*- and *y*-coordinates. In other words, if a window is 100 by 100 pixels, `aButton.setLocation(100,100);` places the `JButton` outside the window, where you cannot see the component.

Figure 16-3 shows a `JDemoLocation` class that uses a call to the `setLocation()` method in the `actionPerformed()` method. The values of the *x*- and *y*-coordinates passed to `setLocation()` are initialized to 0, and then each is increased by 30 every time the user clicks the `JButton`. The `JButton` moves 30 pixels down and to the right every time it is clicked.

```
import javax.swing.*;
import java.awt.*;
import java.awt.event.*;
public class JDemoLocation extends JFrame implements ActionListener
{
    JButton pressButton = new JButton("Press");
    int x = 0, y = 0;
    final int GAP = 30;
    public JDemoLocation()
    {
        setTitle("Location Demo");
        setLayout(new FlowLayout());
        setDefaultCloseOperation(JFrame.EXIT_ON_CLOSE);
        add(pressButton);
        pressButton.addActionListener(this);
    }
    public void actionPerformed(ActionEvent e)
    {
        pressButton.setLocation(x, y);
        x += GAP;
        y += GAP;
    }
    public static void main(String[] args)
    {
        JDemoLocation frame = new JDemoLocation();
        frame.setSize(150, 150);
        frame.setVisible(true);
    }
}
```

**Figure 16-3** The `JDemoLocation` class

Figure 16-4 shows the `JFrame` in four positions: when it starts with the `JButton` in its default position; after the user clicks the `JButton` once, moving it to position 0, 0; after the user clicks it a second time, moving it to position 30, 30; and after the user clicks it a third time, moving it to position 60, 60. If the user continues to click the `JButton`, it moves off the frame surface. You could add a decision to prevent continued progression of the `setLocation()` coordinates.



**Figure 16-4** Execution of the JDemoLocation program



The `setLocation()` method works correctly only when it is used after the layout manager has finished positioning all the application's components (or in cases where no layout manager is functioning). If you try to use `setLocation()` on a component within its container's constructor, the component will not be repositioned because the layout manager will not be finished placing components.

## Creating Graphics Objects

When you call the `paint()` method from an application, you can use the automatically created `Graphics` object that is passed to it, but you can also instantiate your own `Graphics` objects. For example, you might want to use a `Graphics` object when some action occurs, such as a mouse event. Because the `actionPerformed()` method does not supply you with a `Graphics` object automatically, you can create your own.

To display a string when the user clicks a `JButton`, you can code an `actionPerformed()` method such as the following:

```
public void actionPerformed(ActionEvent e)
{
    Graphics draw = getGraphics();
    draw.drawString("You clicked the button!", 50, 100);
}
```

This method instantiates a `Graphics` object named `draw`. (You can use any legal Java identifier.) The `getGraphics()` method provides the `draw` object with `Graphics` capabilities. Then the `draw` object can employ `Graphics` methods such as `setFont()`, `setColor()`, and `drawString()`.

Notice that when you create the `draw` object, you are not calling the `Graphics` constructor directly. (The name of the `Graphics` constructor is `Graphics()`, not `getGraphics()`.) This operation is similar to the way you call `getContentPane()`. You are not allowed to call the `Graphics` or `ContentPane` constructors because those classes are abstract classes.



If you call `getGraphics()` in a frame that is not visible, you receive a `NullPointerException`, and the program will not execute.





Watch the video *Using paint() and repaint()*.

## TWO TRUTHS & A LIE

775

### Learning About the paint() and repaint() Methods

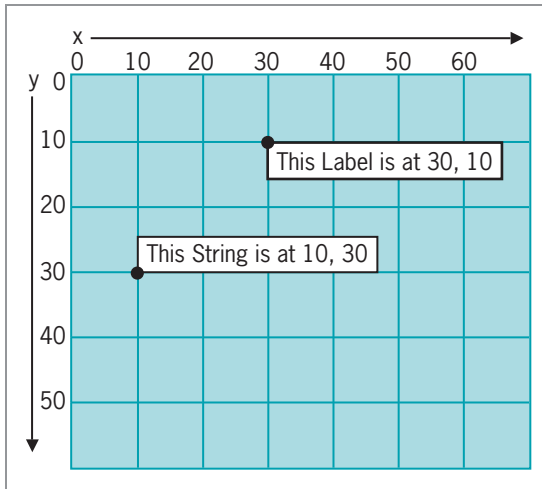
1. Painting can be system triggered (for example, when a component is resized) or application triggered (for example, when a user clicks a button).
2. When the paint() method is called, the Graphics object parameter is preconfigured with the appropriate state for drawing on the component, including the color and font.
3. You override the repaint() method in your programs when you want specific actions to take place when components must be rendered. You usually call the paint() method directly, and it calls repaint().

The false statement is #3. You override the paint() method in your programs when you want specific actions to take place when components must be rendered. You don't usually call the paint() method directly—you call repaint().

## Using the drawString() Method

The **drawString() method** allows you to draw a `String` in a `JFrame` or other component. The `drawString()` method requires three arguments: a `String`, an x-axis coordinate, and a y-axis coordinate.

You are already familiar with x- and y-axis coordinates because you used them with the `setLocation()` method for components. However, there is a minor difference in how you place components using the `setLocation()` method and how you place `Strings` using the `drawString()` method. When you use x- and y-coordinates with components, such as `JButtons` or `JLabels`, the upper-left corner of the component is placed at the coordinate position. When you use x- and y-coordinates with `drawString()`, the lower-left corner of the `String` appears at the coordinates. Figure 16-5 shows the positions of a `JLabel` placed at the coordinates 30, 10 and a `String` placed at the coordinates 10, 30.



**Figure 16-5** Placement of `String` and `JLabel` objects on a frame

The `drawString()` method is a member of the `Graphics` class, so you need to use a `Graphics` object to call it. Recall that the `paint()` method header shows that the method receives a `Graphics` object from the `update()` method. If you use `drawString()` within `paint()`, the `Graphics` object you name in the header is available to you. For example, if you write a `paint()` method with the header `public void paint(Graphics brush)`, you can draw a `String` within your `paint()` method by using a statement such as: `brush.drawString("Hi", 50, 80);`

## Using the `setFont()` and `setColor()` Methods

You can improve the appearance of strings drawn using `Graphics` objects by using the `setFont()` method. The `setFont()` method requires a `Font` object, which, as you may recall from Chapter 14, you can create with a statement such as:

```
Font someFont = new Font("Arial", Font.BOLD, 16);
```

Then you can instruct a `Graphics` object to use the font by inserting the font as the argument in a `setFont()` method. For example, if a `Graphics` object is named `artist` and a `Font` object is named `smallFont`, the font is set to `smallFont` with the following:

```
artist.setFont(smallFont);
```

Figure 16-6 shows an application that uses the `setFont()` method with a `Graphics` object named `brush`.

```
import javax.swing.*;
import java.awt.*;
public class JDemoFont extends JFrame
{
    Font bigFont = new Font("Serif", Font.ITALIC, 48);
    String hello = "Hello";
    public void paint(Graphics brush)
    {
        super.paint(brush);
        brush.setFont(bigFont);
        brush.drawString(hello, 10, 100);
    }
    public static void main(String[] args)
    {
        JDemoFont frame = new JDemoFont();
        frame.setSize(180, 150);
        frame.setVisible(true);
    }
}
```

**Figure 16-6** The JDemoFont class

When the `paint()` method executes in the `JDemoFont` example, `bigFont` is assigned to the automatically created `brush` object. Then the `brush` object is used to draw the `hello` string at position 10, 100. Figure 16-7 shows the output.



**Figure 16-7** Output of the `JDemoFont` program

## Using Color

You can designate a `Graphics` color with the `setColor()` method. As you learned in Chapter 15, the `Color` class contains 13 constants; you can use any of these constants as an argument to the `setColor()` method. For example, you can instruct a `Graphics` object named `brush` to apply green paint by using the following statement:

```
brush.setColor(Color.GREEN);
```

Until you change the color, subsequent graphics output appears as green.

## TWO TRUTHS & A LIE

### Using the drawString() Method

1. The drawString() method requires three arguments: a String, an x-axis coordinate, and a y-axis coordinate.
2. When you use x- and y-coordinates with components, such as JButtons or JLabels, the lower-left corner of the component is placed at the coordinate position, but when you use x- and y-coordinates with drawString(), the upper-left corner of the String appears at the coordinates.
3. The drawString() method is a member of the Graphics class, so you need to use a Graphics object to call it.

The false statement is #2. When you use x- and y-coordinates with components, such as JButtons or JLabels, the upper-left corner of the component is placed at the coordinate position, but when you use x- and y-coordinates with drawString(), the lower-left corner of the String appears at the coordinates.

## Drawing Lines and Shapes

Just as you can draw Strings using a Graphics object and the drawString() method, Java provides you with several methods for drawing a variety of lines and geometric shapes.



Any line or shape is drawn in the current color you set with the setColor() method. When you do not set a color, lines are drawn in black by default.

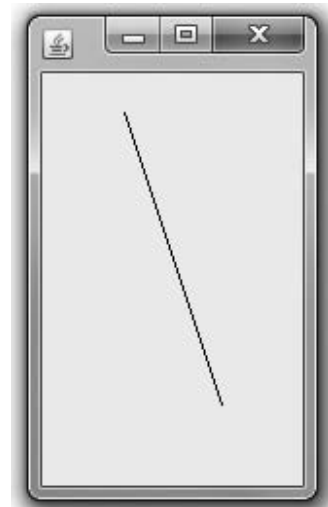


It is almost impossible to draw a picture of any complexity without sketching it first on a piece of graph paper to help you determine correct coordinates.

## Drawing Lines

You can use the **drawLine() method** to draw a straight line between any two points on the screen. The drawLine() method takes four arguments: the x- and y-coordinates of the line's starting point and the x- and y-coordinates of the line's ending point. For example, if you create a Graphics object named pen, then the following statement draws a straight line that slants down and to the right, from position 50, 50 to position 100, 200, as shown in Figure 16-8.

```
pen.drawLine(50, 50, 100, 200);
```



**Figure 16-8** A line created with pen.drawLine(50, 50, 100, 200)



Your downloadable student files contain a `JDemoLine.java` file with a working program that draws the line shown in Figure 16-8.

Because you can start at either end when you draw a line, an identical line is created with the following:

```
pen.drawLine(100, 200, 50, 50);
```

779

## Drawing Rectangles

You could draw a rectangle by drawing four lines. Alternatively, you can use the **`drawRect()` method** and **`fillRect()` method**, respectively, to draw the outline of a rectangle or to draw a solid, or filled, rectangle. Each of these methods requires four arguments. The first two arguments represent the *x*- and *y*-coordinates of the upper-left corner of the rectangle. The last two arguments represent the width and height of the rectangle. For example, the following statement draws a short, wide rectangle that begins at position 20, 100, and is 200 pixels wide by 10 pixels tall:

```
drawRect(20, 100, 200, 10);
```

The **`clearRect()` method** also requires four arguments and draws a rectangle. The difference between using the `drawRect()` and `fillRect()` methods and the `clearRect()` method is that the first two methods use the current drawing color, whereas the `clearRect()` method draws what appears to be an empty or “clear” rectangle. A rectangle created with the `clearRect()` method is not really “clear”; in other words, it is not transparent. When you create a rectangle, you do not see objects that might be hidden behind it. Instead, the `clearRect()` method clears anything drawn from view, showing the original content pane.

For example, the constructor in the `JDemoRectangles` program shown in Figure 16-9 sets the background color of the content pane to blue and sets the layout manager.

```
import javax.swing.*;
import java.awt.*;
import java.awt.Color;
public class JDemoRectangles extends JFrame
{
    Container con = getContentPane();
    public JDemoRectangles()
    {
        con.setBackground(Color.BLUE);
        con.setLayout(new FlowLayout());
    }
    public void paint(Graphics gr)
    {
        super.paint(gr);
        gr.setColor(Color.RED);
    }
}
```

**Figure 16-9** The `JDemoRectangles` class (continues)

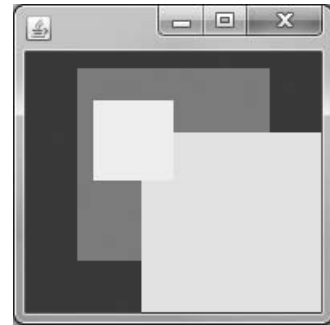
(continued)

```
        gr.fillRect(40, 40, 120, 120);
        gr.setColor(Color.YELLOW);
        gr.fillRect(80, 80, 160, 160);
        gr.clearRect(50, 60, 50, 50);
    }
    public static void main(String[] args)
    {
        JDemoRectangles frame = new JDemoRectangles();
        frame.setSize(200, 200);
        frame.setVisible(true);
    }
}
```

**Figure 16-9** The `JDemoRectangles` class

In the `paint()` method in Figure 16-9, the drawing color is set to red, and a filled rectangle is drawn. Then the drawing color is changed to yellow and a second filled rectangle is drawn to overlap the first. Finally, a smaller, “clear” rectangle is drawn that overlaps the other rectangles. As Figure 16-10 shows, you cannot see the boundaries of the original rectangles in the “clear” area—you simply see that portions of the filled rectangles have been removed from the drawing.

You can create rectangles with rounded corners when you use the `drawRoundRect()` method. The **`drawRoundRect()` method** requires six arguments. The first four arguments match the four arguments required to draw a rectangle: the *x*- and *y*-coordinates of the upper-left corner, the width, and the height. The two additional arguments represent the arc width and height associated with the rounded corners (an **arc** is a portion of a circle). If you assign zeros to the arc coordinates, the rectangle is not rounded; instead, the corners are square. At the other extreme, if you assign values to the arc coordinates that are at least the width and height of the rectangle, the rectangle is so rounded that it is a circle. The `paint()` method in Figure 16-11 draws four rectangles with increasingly large corner arcs. The first rectangle is drawn at coordinates 20, 40, and the horizontal coordinate is increased by 100 for each subsequent rectangle. Each rectangle is the same width and height, but each set of arc values becomes larger, producing rectangles that are not rounded, slightly rounded, very rounded, and completely rounded in sequence. Figure 16-12 shows the program’s output. Notice that a rectangle with the same height and width is a square, and a completely rounded square is actually a circle.



**Figure 16-10** Output of the `JDemoRectangles` program

```
import javax.swing.*;
import java.awt.*;
public class JDemoRoundRectangles extends JFrame
{
    public void paint(Graphics gr)
    {
        super.paint(gr);
        int x = 20;
        int y = 40;
        final int WIDTH = 80, HEIGHT = 80;
        final int HORIZONTAL_GAP = 100;
        for(int arcSize = x; arcSize <= HEIGHT; arcSize += 20)
        {
            gr.drawRoundRect(x, y, WIDTH, HEIGHT, arcSize, arcSize);
            x += HORIZONTAL_GAP;
        }
    }
    public static void main(String[] args)
    {
        JDemoRoundRectangles frame = new JDemoRoundRectangles();
        frame.setSize(420, 140);
        frame.setVisible(true);
    }
}
```

Figure 16-11 The JDemoRoundRectangles class

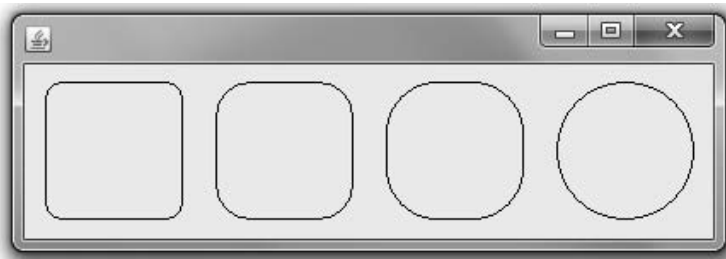


Figure 16-12 Output of the JDemoRoundRectangles program

Java also contains a `fillRoundRect()` method that creates a filled rounded rectangle and a `clearRoundRect()` method that creates a clear rounded rectangle.

## Creating Shadowed Rectangles

The **`draw3DRect()` method** is a minor variation on the `drawRect()` method. You use the `draw3DRect()` method to draw a rectangle that appears to have “shadowing” on two of its edges—the effect is that of a rectangle that is lit from the upper-left corner and slightly raised or slightly lowered. The `draw3DRect()` method requires a fifth argument in addition

to the x- and y-coordinates and width and height required by the `drawRect()` method. The fifth argument is a Boolean value, which is true if you want the raised rectangle effect (darker on the right and bottom) and false if you want the lowered rectangle effect (lighter on the right and bottom). There is also a **`fill3DRect()` method** for creating filled three-dimensional (3D) rectangles; this method is used in the program in Figure 16-13.

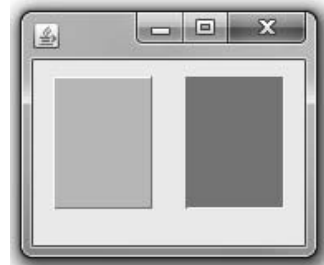
```
import javax.swing.*;
import java.awt.*;
import java.awt.Color;
public class JDemo3DRectangles extends JFrame
{
    public void paint(Graphics gr)
    {
        super.paint(gr);
        final int WIDTH = 60, HEIGHT = 80;
        gr.setColor(Color.PINK);
        gr.fill3DRect(20, 40, WIDTH, HEIGHT, true);
        gr.fill3DRect(100, 40, WIDTH, HEIGHT, false);
    }
    public static void main(String[] args)
    {
        JDemo3DRectangles frame = new JDemo3DRectangles();
        frame.setSize(180, 150);
        frame.setVisible(true);
    }
}
```

**Figure 16-13** The `JDemo3DRectangles` class

The program in Figure 16-13 creates two filled 3D rectangles in pink. (The 3D methods work best with lighter drawing colors.) You can see that the shadowing effect on the output in Figure 16-14 is very subtle; the shadowing is only one pixel wide.

## Drawing Ovals

You can draw an oval using the `drawRoundRect()` or `fillRoundRect()` method, but it is usually easier to use the **`drawOval()` and `fillOval()` methods**. The `drawOval()` and `fillOval()` methods both draw ovals using the same four arguments that rectangles use. When you supply `drawOval()` or `fillOval()` with x- and y-coordinates for the upper-left corner and width and height measurements, you can picture an imaginary rectangle that uses the four arguments. The oval is then placed within the rectangle so it touches the



**Figure 16-14** Output of the `JDemo3DRectangles` program



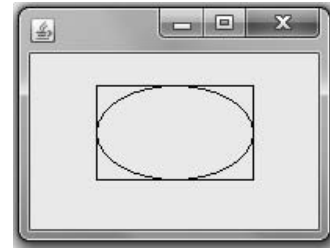
rectangle at the center of each of the rectangle's sides. For example, suppose that you create a `Graphics` object named `tool` and draw a rectangle with the following statement:

```
tool.drawRect(50, 50, 100, 60);
```

Suppose that then you create an oval with the same coordinates as follows:

```
tool.drawOval(50, 50, 100, 60);
```

The output appears as shown in Figure 16-15, with the oval edges just skimming the rectangle's sides.



**Figure 16-15** Demonstration of the `drawOval()` method

783



Your downloadable student files contain a `JDemoOval.java` file that produces the frame in Figure 16-15.

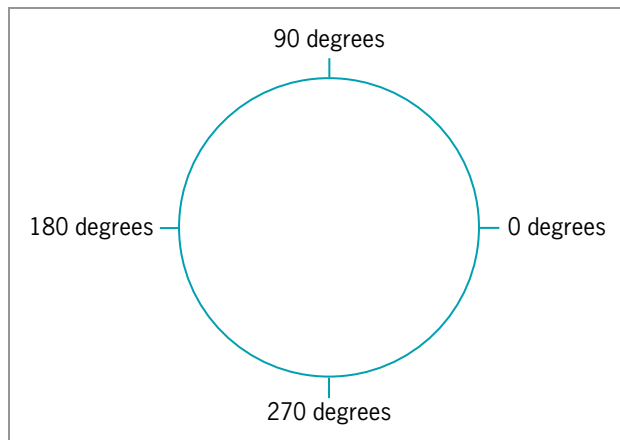
If you draw a rectangle with identical height and width, you draw a square. If you draw an oval with identical height and width, you draw a circle.

## Drawing Arcs

In Java, you can draw an arc using the `Graphics` **`drawArc()` method**. To use the `drawArc()` method, you provide six arguments:

- The  $x$ - and  $y$ -coordinates of the upper-left corner of an imaginary rectangle that represents the bounds of the imaginary circle that contains the arc
- The width and height of the imaginary rectangle that represents the bounds of the imaginary circle that contains the arc
- The beginning arc position and the arc angle

Arc positions and angles are measured in degrees; there are 360 degrees in a circle. The  $0^\circ$  position for any arc is the three o'clock position, as shown in Figure 16-16. The other 359 degree positions increase as you move counterclockwise around an imaginary circle, so  $90^\circ$  is at the top of the circle in the 12 o'clock position,  $180^\circ$  is opposite the starting position at nine o'clock, and  $270^\circ$  is at the bottom of the circle in the six o'clock position.



**Figure 16-16** Arc positions

The arc angle is the number of degrees over which you want to

draw the arc, traveling counterclockwise from the starting position. For example, you can draw a half circle by indicating an arc angle of 180° or a quarter circle by indicating an arc angle of 90°. If you want to travel clockwise from the starting position, you express the degrees as a negative number. Just as when you draw a line, when drawing any arc you can take one of two approaches: either start at point A and travel to point B, or start at point B and travel to point A. For example, to create an arc object using a `Graphics` object named `g` that looks like the top half of a circle, the following statements produce identical results:

```
g.drawArc(x, y, w, h, 0, 180);
g.drawArc(x, y, w, h, 180, -180);
```

The first statement starts an arc at the three o'clock position and travels 180 degrees counterclockwise to the nine o'clock position. The second statement starts at nine o'clock and travels clockwise to three o'clock.

The **`fillArc()` method** creates a solid arc. The arc is drawn, and two straight lines are drawn from the arc endpoints to the center of the imaginary circle whose perimeter the arc occupies. For example, assuming you have declared a `Graphics` object named `g`, the following two statements together produce the output shown in Figure 16-17:

```
g.fillArc(20, 50, 100, 100, 20, 320);
g.fillArc(60, 50, 100, 100, 340, 40);
```

Each of the two arcs is in a circle that has a size of 100 by 100. The first arc almost completes a full circle, starting at position 20 (near two o'clock) and ending 320 degrees around the circle (at position 340, near four o'clock). The second filled arc more closely resembles a pie slice, starting at position 340 and extending 40 degrees to end at position 20.

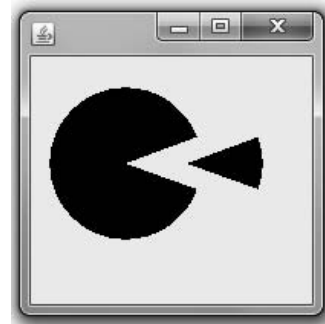


Figure 16-17 Two filled arcs



Your downloadable student files contain a program named `JDemoFillArc.java` that produces Figure 16-17.

## Creating Polygons

When you want to create a shape that is more complex than a rectangle, you can use a sequence of calls to the `drawLine()` method, or you can use the **`drawPolygon()` method** to draw complex shapes. The `drawPolygon()` method requires three arguments: two integer arrays and a single integer.

The first integer array holds a series of x-coordinate positions, and the second array holds a series of corresponding y-coordinate positions. These positions represent points that are connected to form the polygon. The third integer argument is the number of pairs of points you want to connect. If you don't want to connect all the points represented by the array values, you can assign this third argument integer a value that is smaller than the number of

elements in each array. However, an error occurs if the third argument is a value higher than the available number of coordinate pairs.

For example, examine the code shown in Figure 16-18, which is a `JFrame` application that has one task: to draw a star-shaped polygon.

```
import javax.swing.*;
import java.awt.*;
public class JStar extends JFrame
{
    public void paint(Graphics gr)
    {
        super.paint(gr);
        int xPoints[] = {42, 52, 72, 52, 60, 40, 15, 28, 9, 32, 42};
        int yPoints[] = {38, 62, 68, 80, 105, 85, 102, 75, 58, 60, 38};
        gr.drawPolygon(xPoints, yPoints, xPoints.length);
    }
    public static void main(String[] args)
    {
        JStar frame = new JStar();
        frame.setSize(80, 150);
        frame.setVisible(true);
    }
}
```

785

**Figure 16-18** The `JStar` class

In the `JStar` program, two parallel arrays are assigned *x*- and *y*-coordinates. It is almost impossible to create a program like this without sketching the desired shape on a piece of graph paper to discover appropriate coordinate values. The `drawPolygon()` method uses the two arrays and the length of one of the arrays for the number of points. The program's output appears in Figure 16-19.

You can use the **`fillPolygon()` method** to draw a solid shape. The major difference between the `drawPolygon()` and `fillPolygon()` methods is that if the beginning and ending points used with the `fillPolygon()` method are not identical, the two endpoints are connected by a straight line before the polygon is filled with color.

Rather than providing the `fillPolygon()` method with three arguments, you can also create a `Polygon` object and pass the constructed object as a single argument to the `fillPolygon()` method. The `Polygon` constructor requires an array of *x*-coordinates, an array of *y*-coordinates, and a size. For example, you can create a filled polygon using the following statements:



**Figure 16-19** Output of the `JStar` program

```
Polygon someShape = new Polygon(xPoints, yPoints, xPoints.length);  
gr.fillPolygon(someShape);
```

The `Polygon` class also has a default constructor, so you can instantiate an empty `Polygon` object (with no points) using the following statement:

```
Polygon someFutureShape = new Polygon();
```

You use the **`addPoint()` method** in statements such as the following to add points to the polygon later:

```
someFutureShape.addPoint(100, 100);  
someFutureShape.addPoint(150, 200);  
someFutureShape.addPoint(50, 250);
```

It is practical to use `addPoint()` instead of coding the point values when you want to write a program in which you calculate points later or in which the user enters polygon point values. Points can be added to the polygon indefinitely.

## Copying an Area

After you create a graphics image, you might want to create copies of the image. For example, you might want a company logo to appear several times in an application. Of course, you can redraw the picture, but you can also use the **`copyArea()` method** to copy any rectangular area to a new location. The `copyArea()` method requires six parameters:

- The x- and y-coordinates of the upper-left corner of the area to be copied
- The width and height of the area to be copied
- The horizontal and vertical displacement of the destination of the copy

For example, the following line of code causes a `Graphics` object named `gr` to copy an area 20 pixels wide by 30 pixels tall from the upper-left corner of your `JFrame` (coordinates 0, 0) to an area that begins 100 pixels to the right and 50 pixels down:

```
gr.copyArea(0, 0, 20, 30, 100, 50);
```



Watch the video *Drawing Lines and Shapes*.

## TWO TRUTHS & A LIE

### Drawing Lines and Shapes

1. You can use the `drawLine()` method to draw a straight line between any two points on the screen.
2. You can use methods named `drawRect()`, `fillRect()`, `clearRect()`, `drawOval()`, and `fillOval()` to create a variety of shapes.
3. When you draw an arc, the zero-degree position is at 12 o'clock on an imaginary clock, and the 90-degree position is at three o'clock.

The false statement is #3. When you draw an arc, the zero-degree position is at three o'clock, and the degree values increase as you move counterclockwise in a 360-degree circle, so the 90-degree position is at 12 o'clock.

787

## Learning More About Fonts

As you add more components in your GUI applications, positioning becomes increasingly important. In particular, when you draw `Strings` using different fonts, it is difficult to place them correctly so they don't overlap, making them difficult or impossible to read. In addition, the number of available fonts varies greatly across operating systems, so even when you define a font using a string argument such as "Arial" or "Courier", you have no guarantee that the font will be available on every computer that runs your application. If a user's computer does not have the requested font loaded, Java chooses a default replacement font, so you can never be completely certain how your output will look. Fortunately, Java provides many useful methods for obtaining information about the fonts you use.

You can discover the fonts that are available on your system by using the **`getAvailableFontFamilyNames()` method**, which is part of the `GraphicsEnvironment` class defined in the `java.awt` package. The `GraphicsEnvironment` class describes the collection of `Font` objects and `GraphicsDevice` objects available to a Java application on a particular platform. The `getAvailableFontFamilyNames()` method returns an array of `String` objects that are the names of available fonts. For example, the following statements declare a `GraphicsEnvironment` object named `ge`, and then use the object with the `getAvailableFontFamilyNames()` method to store the font names in a string array:

```
GraphicsEnvironment ge =
    GraphicsEnvironment.getLocalGraphicsEnvironment();
String[] fontnames = ge.getAvailableFontFamilyNames();
```

Notice in the preceding example that you can't instantiate the `GraphicsEnvironment` object directly. Instead, you must get a reference object to the current computer environment by calling the static `getLocalGraphicsEnvironment()` method. Figure 16-20 shows a `JFrame`

that lists all the available font names on the computer on which the program was executed. After the `GraphicsEnvironment` object is created and the `getAvailableFontFamilyNames()` method is used to retrieve the array of font names, the names are displayed on the screen using a `for` loop in which the horizontal coordinate where each font `String` is drawn is increased by a fixed value, so that five columns are displayed equally spaced across the `JFrame` surface. After five items are displayed, the horizontal coordinate is set back to 10 and the vertical coordinate is increased so that the next five-column row is displayed below the previous one. The output for one specific computer is shown in Figure 16-21.

```
import javax.swing.*;
import java.awt.*;
public class JFontList extends JFrame
{
    public void paint(Graphics gr)
    {
        super.paint(gr);
        int i, x, y = 40;
        final int VERTICAL_SPACE = 10;
        final int HORIZONTAL_SPACE = 160;
        GraphicsEnvironment ge =
            GraphicsEnvironment.getLocalGraphicsEnvironment();
        String[] fontnames = ge.getAvailableFontFamilyNames();
        for(i = 0; i < fontnames.length; i += 5)
        {
            x = 10;
            gr.setFont(new Font("Arial", Font.PLAIN, 10));
            gr.drawString(fontnames[i], x, y);
            if(i + 1 < fontnames.length)
                gr.drawString(fontnames[i + 1], x += HORIZONTAL_SPACE, y);
            if(i + 2 < fontnames.length)
                gr.drawString(fontnames[i + 2], x += HORIZONTAL_SPACE, y);
            if(i + 3 < fontnames.length)
                gr.drawString(fontnames[i + 3], x += HORIZONTAL_SPACE, y);
            if(i + 4 < fontnames.length)
                gr.drawString(fontnames[i + 4], x += HORIZONTAL_SPACE, y);
            y = y + VERTICAL_SPACE;
        }
    }
    public static void main(String[] args)
    {
        JFontList frame = new JFontList();
        frame.setSize(820, 620);
        frame.setVisible(true);
    }
}
```

Figure 16-20 The `JFontList` class

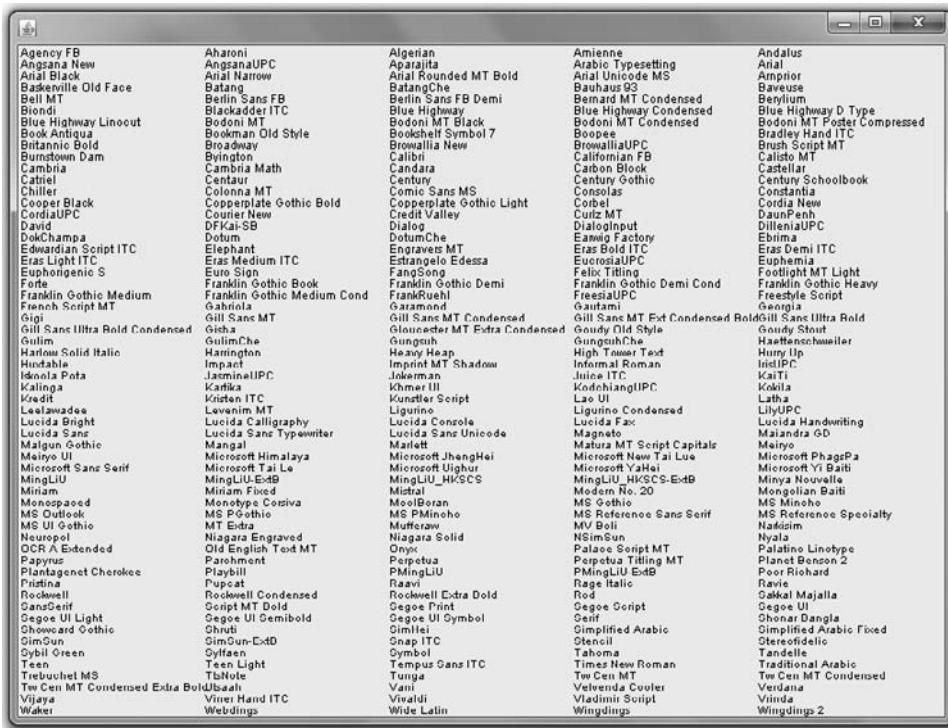


Figure 16-21 Output of the JFontList program

## Discovering Screen Statistics Using the Toolkit Class

Frequently, before you can determine the best Font size to use, it is helpful to know statistics about the screen on which the Font will be displayed. For example, you can discover the resolution and screen size on your system by using the `getScreenResolution()` and `getScreenSize()` methods, which are part of the Toolkit class.

The `getDefaultToolkit()` method provides information about the system in use. The `getScreenResolution()` method returns the number of pixels as an integer. You can create a Toolkit object and get the screen resolution using the following code:

```
Toolkit tk = Toolkit.getDefaultToolkit();
int resolution = tk.getScreenResolution();
```

The Dimension class is useful for representing the width and height of a user interface component, such as a JFrame or a JButton. The Dimension class has three constructors:

- The `Dimension()` method creates an instance of `Dimension` with a width of 0 and a height of 0.
- `Dimension(Dimension d)` creates an instance of `Dimension` whose width and height are the same as for the specified dimension.
- `Dimension(int width, int height)` constructs a `Dimension` and initializes it to the specified width and height.

The `getScreenSize()` method, a member of the `Toolkit` object, returns an object of type `Dimension`, which specifies the width and height of the screen in pixels. Knowing the number of pixels for the width and height of your display is useful to set the coordinates for the position, width, and height of a window. For example, the following code stores the width and height of a screen in separate variables:

```
Toolkit tk = Toolkit.getDefaultToolkit();
Dimension screen = tk.getScreenSize();
int width = screen.width;
int height = screen.height;
```

## Discovering Font Statistics

Typesetters and desktop publishers measure the height of every font in three parts: ascent, descent, and leading.

**Ascent** is the height of an uppercase character from a baseline to the top of the character. **Descent** measures the part of characters that “hang below” the baseline, such as the tails on the lowercase letters *g* and *j*. **Leading**

(pronounced *ledging*) is the amount of space between the bottom of the descent of one line and the top of the characters in the successive line of type. The **height of a font** is the sum of the leading, ascent, and descent. Figure 16-22 labels each of these measurements.

You can discover a font’s statistics by first using the `Graphics` class `getFontMetrics()` method to return a `FontMetrics` object, and then by using one of the following `FontMetrics` class methods with the object to return one of a `Font`’s statistics:

- `public int getLeading()`
- `public int getAscent()`
- `public int getDescent()`
- `public int getHeight()`



Another method, `getLineMetrics()`, is more complicated to use, but returns similar font statistics. For more details, see <http://java.sun.com>.

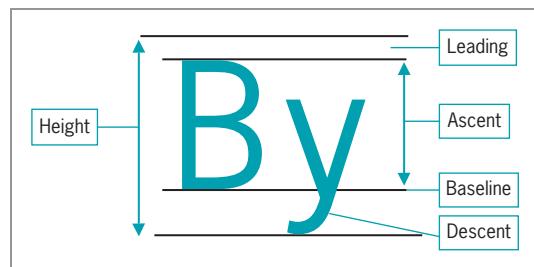


Figure 16-22 Parts of a font’s height

Each of these methods returns an integer value representing the font size in points (one point measures 1/72 of an inch) of the requested portion of the `Font` object. For example, if you define a `Font` object named `myFont` and a `Graphics` object named `paintBrush`, you can set the current font for the `Graphics` object by using the following statements:

```
paintBrush.setFont(myFont);
int heightOfFont = paintBrush.getFontMetrics().getHeight();
```





When you define a `Font` object, you use point size. However, when you use the `FontMetrics` `get` methods, the sizes are returned in pixels.

Then the `heightOfFont` variable holds the total height of `myFont` characters.

A practical use for discovering the height of a font is to space `Strings` correctly as you display them. For example, instead of placing every `String` in a series vertically equidistant from the previous `String` with a statement such as the following:

```
pen.drawString("Some string", x, y += INCREASE);
```

(where `INCREASE` is always the same), you can make the actual increase in the vertical position dependent on the font. If you code the following, you are assured that each `String` has enough room, and appears regardless of which font is currently in use by the `Graphics` pen object:

```
pen.drawString("Some string",
    x, y += pen.getFontMetrics().getHeight());
```

When you create a `String`, you know how many characters are in the `String`. However, you cannot be certain which font Java will use or substitute, and because fonts have different measurements, it is difficult to know the exact width of the `String` that appears in a `JFrame`. Fortunately, the `FontMetrics` class contains a `stringWidth()` method that returns the integer width of a `String`. As an argument, the **`stringWidth()` method** requires the name of a `String`. For example, if you create a `String` named `myString`, you can retrieve the width of `myString` with the following code:

```
int width = gr.getFontMetrics().stringWidth(myString);
```



Watch the video *Font Methods*.

## TWO TRUTHS & A LIE

### Learning More About Fonts

1. Java is widely used partly because its fonts are guaranteed to look the same on all computers.
2. You can discover the resolution and screen size on your system by using the `getScreenResolution()` and `getScreenSize()` methods, which are part of the `Toolkit` class.
3. Ascent is the height of an uppercase character from a baseline to the top of the character, and descent measures the part of characters that “hang below” the baseline, such as the tail on the lowercase letter `y`.

The false statement is #1. If a user's computer does not have a font you have requested, Java chooses a default replacement font, so you can never be completely certain how your output will look.

## Drawing with Java 2D Graphics

Drawing operations earlier in this chapter were called using a `Graphics` object—either an automatically generated one that was passed to the `paint()` method or one the programmer instantiated. In addition, you can call drawing operations using an object of the **Graphics2D class**. The advantage of using Java 2D objects is the higher-quality, two-dimensional (2D) graphics, images, and text they provide.

Features of some of the 2D classes include:

- Fill patterns, such as gradients
- Strokes that define the width and style of a drawing stroke
- Anti-aliasing, a graphics technique for producing smoother screen graphics

`Graphics2D` is found in the `java.awt` package. A `Graphics2D` object is produced by casting, or converting and promoting, a `Graphics` object. For example, in a `paint()` method that automatically receives a `Graphics` object, you can cast the object to a `Graphics2D` object using the following code:

```
public void paint(Graphics pen)
{
    Graphics2D newpen = (Graphics2D)pen;
```

The process of drawing with Java 2D objects includes:

- Specifying the rendering attributes
- Setting a drawing stroke
- Creating objects to draw

### Specifying the Rendering Attributes

The first step in drawing a 2D object is to specify how a drawn object is rendered. Whereas drawings that are not 2D can only use the attribute `Color`, with 2D you can designate other attributes, such as line width and fill patterns. You specify 2D colors by using the `setColor()` method, which works like the `Graphics` method of the same name. Using a `Graphics2D` object, you can set the color to black using the following code:

```
gr2D.setColor(Color.BLACK);
```

**Fill patterns** control how a drawing object is filled in. In addition to using a solid color, 2D fill patterns can be a gradient fill, a texture, or even a pattern that you devise. A fill pattern is created by using the `setPaint()` method of `Graphics2D` with a fill pattern object as the only argument. Classes from which you can construct a fill pattern include `Color`, `TexturePaint`, and `GradientPaint`.

A **gradient fill** is a gradual shift from one color at one coordinate point to a different color at a second coordinate point. If the color shift occurs once between the points—for example, slowly changing from yellow to red—you are using an **acyclic gradient**, one that does not

cycle between the colors. If the shift occurs repeatedly, such as from yellow to red and back to yellow again, you are using a **cyclic gradient**, one that does cycle between the colors.

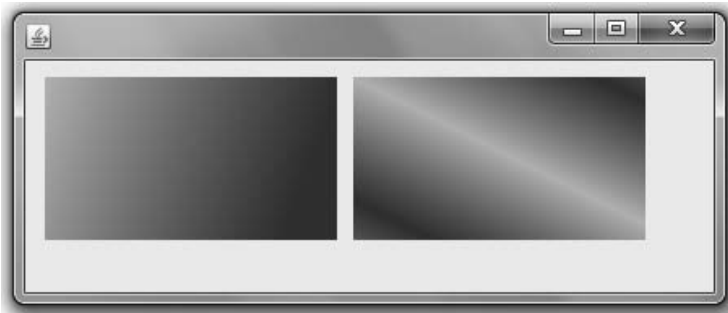
Figure 16-23 shows an application that demonstrates acyclic and cyclic gradient fills. The first shaded `setPaint()` method call sets a gradient that begins at coordinates 20, 40 in `LIGHT_GRAY` and ends at coordinates 180, 100 in `DARK_GRAY`. The last argument to the `GradientPaint()` constructor is `false`, indicating an acyclic gradient. After the `Graphics2D` object's paint is applied, a filled rectangle is drawn over the same area. These statements produce the rectangle on the left in Figure 16-24, which gradually shifts from light gray to dark gray, moving down and to the right. The second shaded `setPaint()` statement in Figure 16-23 establishes a new gradient beginning farther to the right. In this statement, the final argument to `GradientPaint()` is `true`, creating a cyclic gradient. As you can see on the right side in Figure 16-24, this rectangle's shading changes gradually across its surface.



Later in this chapter, you will learn about the `Rectangle2D.Double` class used to create the rectangles in this application.

```
import javax.swing.*;
import java.awt.*;
import java.awt.geom.*;
import java.awt.Color;
public class JGradient extends JFrame
{
    public void paint(Graphics gr)
    {
        super.paint(gr);
        int x = 20, y = 40, x2 = 180, y2 = 100;
        Graphics2D gr2D = (Graphics2D)gr;
        gr2D.setPaint(new GradientPaint(x, y, Color.LIGHT_GRAY,
            x2, y2, Color.DARK_GRAY, false));
        gr2D.fill(new Rectangle2D.Double(x, y, x2, y2));
        x = 210;
        gr2D.setPaint(new GradientPaint(x, y, Color.LIGHT_GRAY,
            x2, y2, Color.DARK_GRAY, true));
        gr2D.fill(new Rectangle2D.Double(x, y, x2, y2));
    }
    public static void main(String[] args)
    {
        JGradient frame = new JGradient();
        frame.setSize(440, 180);
        frame.setVisible(true);
    }
}
```

**Figure 16-23** The `JGradient` class



**Figure 16-24** Output of the JGradient application

## Setting a Drawing Stroke

All lines in non-2D graphics operations are drawn as solid, with square ends and a line width of one pixel. With the 2D methods, the drawing line is a **stroke**, which represents a single movement as if you were using a drawing tool, such as a pen or a pencil. In Java 2D, you can change a stroke's width using the **setStroke()** method. Stroke is actually an interface; the class that defines line types and implements the Stroke interface is named **BasicStroke**. A BasicStroke constructor takes three arguments:

- A float value representing the line width
- An int value determining the type of cap decoration at the end of a line
- An int value determining the style of juncture between two line segments

BasicStroke class variables determine the endcap and juncture style arguments. **Endcap styles** apply to the ends of lines that do not join with other lines, and include CAP\_BUTT, CAP\_ROUND, and CAP\_SQUARE. **Juncture styles**, for lines that join, include JOIN\_MITER, JOIN\_ROUND, and JOIN\_BEVEL.

The following statements create a BasicStroke object and make it the current stroke:

```
BasicStroke aLine = new BasicStroke(1.0f,
    BasicStroke.CAP_ROUND, BasicStroke.JOIN_ROUND);
```

Figure 16-25 shows a program that draws a rectangle using a very wide stroke.

```
import javax.swing.*;
import java.awt.*;
import java.awt.geom.*;
public class JStroke extends JFrame
{
    public void paint(Graphics gr)
    {
        super.paint(gr);
        Graphics2D gr2D = (Graphics2D)gr;
```

**Figure 16-25** The JStroke class (continues)

(continued)

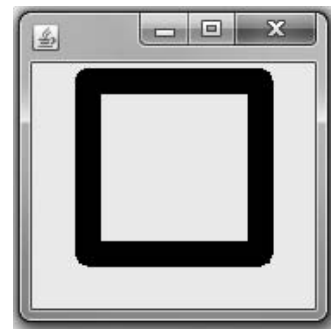
```

        BasicStroke aStroke = new BasicStroke(15.0f,
            BasicStroke.CAP_ROUND, BasicStroke.JOIN_ROUND);
        gr2D.setStroke(aStroke);
        gr2D.draw(new Rectangle2D.Double(40, 40, 100, 100));
    }
    public static void main(String[] args)
    {
        JStroke frame = new JStroke();
        frame.setSize(180, 180);
        frame.setVisible(true);
    }
}

```

**Figure 16-25** The JStroke class

The shaded statement in the `JStroke` class sets the `BasicStroke` width to 15 pixels using round endcap and juncture parameters. Notice that the line width value is followed by an `f`, making the value a `float` instead of a `double`. Figure 16-26 shows the drawn rectangle.



**Figure 16-26** Output of the `JStroke` program

## Creating Objects to Draw

After you have created a `Graphics2D` object and specified the rendering attributes, you can create different objects to draw. Objects that are drawn in Java 2D are first created by defining them as geometric shapes using the `java.awt.geom` package classes. You can define the shape of lines, rectangles, ovals, and arcs; after you define the shape, you use it as an argument to the `draw()` or `fill()` methods. The `Graphics2D` class does not have different methods for each shape you can draw.

### Lines

Lines are created using the `Line2D.Float` class or the `Line2D.Double` class. Each of these classes has a constructor that takes four arguments, which are the `x`- and `y`-coordinates of the line endpoints. For example, to create a line from the endpoint 60, 5 to the endpoint 13, 28, you could write the following:

```
Line2D.Float line = new Line2D.Float(60F, 5F, 13F, 28F);
```

It also is possible to create lines based on points. You can use the `Point2D.Float` or `Point2D.Double` class to create points that have both `x`- and `y`-coordinates. For example, you could create two `Point2D.Float` points using the following code:

```
Point2D.Float pos1 = new Point2D.Float(60F, 5F);
Point2D.Float pos2 = new Point2D.Float(13F, 28F);
```

Then the code to create a line might be:

```
Line2D.Float line = new Line2D.Float (pos1, pos2);
```

## Rectangles

796

You can create rectangles by using a `Rectangle2D.Float` or a `Rectangle2D.Double` class. As with the `Line` and `Point` classes, these two classes are distinguished by the type of argument used to call their constructors: `float` or `double`. Both `Rectangle2D.Float` and `Rectangle2D.Double` can be created using four arguments representing the x-coordinate, y-coordinate, width, and height. For example, the following code creates a `Rectangle2D.Float` object named `rect` at 10, 10 with a width of 50 and height of 40:

```
Rectangle2D.Float rect = new Rectangle2D.Float(10F, 10F, 50F, 40F);
```

## Ovals

You can create `Oval` objects with the `Ellipse2D.Float` or `Ellipse2D.Double` class. The `Ellipse2D.Float` constructor requires four arguments representing the x-coordinate, y-coordinate, width, and height. The following code creates an `Ellipse2D.Float` object named `e11` at 10, 73 with a width of 40 and height of 20:

```
Ellipse2D.Float e11 = new Ellipse2D.Float(10F, 73F, 40F, 20F);
```

## Arcs

You can create arcs with the `Arc2D.Float` or `Arc2D.Double` class. The `Arc2D.Float` constructor takes seven arguments. The first four arguments represent the x-coordinate, y-coordinate, width, and height that apply to the ellipse of which the arc is a part. The remaining three arguments are as follows:

- The starting position of the arc
- The number of degrees it travels
- An integer field indicating how it is closed

The starting position is expressed in degrees in the same way as in the `Graphics` class `drawArc()` method; for example, 0 is the three o'clock position. The number of degrees traveled by the arc is specified in a counterclockwise direction using positive numbers. The final argument uses one of the three class fields:

- `Arc2D.PIE` connects the arc to the center of an ellipse and looks like a pie slice.
- `Arc2D.CHORD` connects the arc's endpoints with a straight line.
- `Arc2D.OPEN` is an unclosed arc.

To create an `Arc2D.Float` object named `ac` at 10, 133 with a width of 30 and height of 33, a starting degree of 30, 120 degrees traveled, and using the class variable `Arc2D.PIE`, you use the following statement:

```
Arc2D.Float ac = new Arc2D.Float(10, 133, 30, 33, 30, 120, Arc2D.PIE);
```

## Polygons

You create a `Polygon` object by defining movements from one point to another. The movement that creates a polygon is a `GeneralPath` object; the `GeneralPath` class is found in the `java.awt.geom` package.

- The statement `GeneralPath pol = new GeneralPath();` creates a `GeneralPath` object named `pol`.
- The `moveTo()` method of `GeneralPath` is used to create the beginning point of the polygon. Thus, the statement `pol.moveTo(10F, 193F);` starts the polygon named `pol` at the coordinates 10, 193.
- The `lineTo()` method is used to create a line that ends at a new point. The statement `pol.lineTo(25F, 183F);` creates a second point using the arguments of 25 and 183 as the x- and y-coordinates of the new point.
- The statement `pol.lineTo(100F, 223F);` creates a third point. The `lineTo()` method can be used to connect the current point to the original point. Alternatively, you can use the `closePath()` method without any arguments.

### TWO TRUTHS & A LIE

#### Drawing with Java 2D Graphics

1. The advantage of using Java 2D objects is the higher-quality, 2D graphics, images, and text they provide.
2. With Java's 2D graphics, you can designate attributes such as color, line width, and fill patterns.
3. With Java's 2D methods, the drawing line is a brush that represents a single movement as if you were using a drawing tool, such as a pen or a pencil.

The false statement is #3. With Java's 2D methods, the drawing line is a stroke that represents a single movement as if you were using a drawing tool, such as a pen or a pencil.

## You Do It

### Using the drawString() Method

In the next steps, you will write a class that extends JFrame and that uses the drawString() method.

798

#### To use the drawString() method:

1. Open a new text file, and begin a class definition for a JDemoGraphics class by typing the following:

```
import javax.swing.*;*;  
import java.awt.*;*;  
public class JDemoGraphics extends JFrame  
{
```

2. Declare a String by typing the following:

```
String movieQuote = new String("You talkin' to me?");
```

3. Add a constructor to set the default close operation:

```
public JDemoGraphics()  
{  
    setDefaultCloseOperation(JFrame.EXIT_ON_CLOSE);  
}
```

4. Type the following paint() method that calls the super() method and uses a Graphics object to draw the movieQuote String.

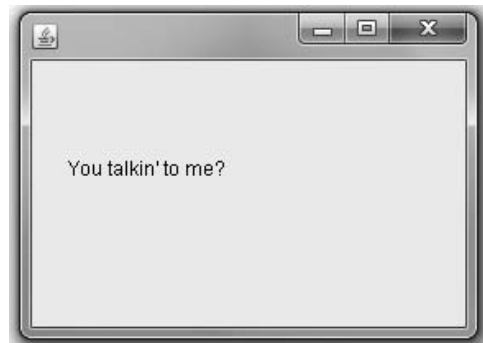
```
public void paint(Graphics gr)  
{  
    super.paint(gr);  
    gr.drawString(movieQuote, 30, 100);  
}
```

5. Add a main() method that instantiates a JDemoGraphics object and sets its size and visibility. Then add the closing curly brace for the class:

```
public static void main(String[] args)  
{  
    JDemoGraphics frame = new JDemoGraphics();  
    frame.setSize(280, 200);  
    frame.setVisible(true);  
}
```

6. Save the file as **JDemoGraphics.java**, and then compile and execute it. The program's output appears in Figure 16-27.

7. Close the JFrame to end the application.



**Figure 16-27** Output of the JDemoGraphics program



## Using Fonts and Colors

Next, you will use your knowledge of fonts and colors to set the color and font style of a drawn String.

### To add a Font and Color to your JDemoGraphics class:

799

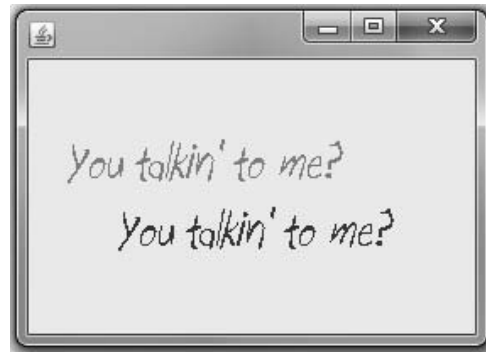
1. Open the **JDemoGraphics.java** text file in your text editor, and immediately save it as **JDemoGraphics2.java**. Change the class name, the constructor name, and the two references in the `main()` method to match.
2. Add a new `import` statement to the current list so that the application can use color:  
**`import java.awt.Color;`**
3. Just after the `movieQuote` declaration, add a `Font` object by typing the following:  
**`Font bigFont = new Font("Boopee", Font.ITALIC, 30);`**
4. Within the `paint()` method after the call to `super()`, type the following statements so the `gr` object uses the `bigFont` object and the color magenta:

```
gr.setFont(bigFont);  
gr.setColor(Color.MAGENTA);
```

5. Following the existing `drawString()` method call, type the following lines to change the color and add another call to the `drawString()` method:

```
gr.setColor(Color.BLUE);  
gr.drawString(movieQuote, 60, 140);
```

6. Save the file, compile it, and execute it. The program's output appears in Figure 16-28. Although the figure is shown in black and white in this book, notice that the Strings on your screen are displayed as magenta and blue text. The font that appears in your program might be different from the one shown in the figure, depending on your computer's installed fonts. (You can view a list of available fonts on your computer by executing a program similar to the `JFontList` program shown in Figure 16-20.)
7. Close the `JFrame` to end the application.



**Figure 16-28** Output of the `JDemoGraphics2` program

## Creating Your Own Graphics Object

Next, you will create a `Graphics` object named `pen` and use the object to draw a `String` on the screen. The text of the `String` will appear to move each time a  `JButton`  is clicked.

800

### To write an application in which you create your own `Graphics` object:

1. Open a new text file in your text editor, and type the following `import` statements for the program:

```
import javax.swing.*;
import java.awt.*;
import java.awt.event.*;
import java.awt.Color;
```

2. Start typing the following class that extends `JFrame` and uses the mouse. The class defines a `String`, a `JButton`, a `Font`, and four integers: two to hold `x`- and `y`-coordinates, one to act as a constant size to measure the gap between lines displayed on the screen, and one to hold the size of the `JFrame`:

```
public class JDemoCreateGraphicsObject extends JFrame
    implements ActionListener
{
    String movieQuote = new String("Here's looking at you, kid");
    JButton moveButton = new JButton("Move It");
    Font broadwayFont = new Font("Broadway", Font.ITALIC, 12);
    int x = 10, y = 50;
    final int GAP = 20;
    final int SIZE = 400;
```

3. Type the following constructor, which changes the background color and sets the layout of the `Container`, adds the `JButton`, prepares the `JFrame` to listen for `JButton` events, sets the close operation, and sets the size of the frame:

```
public JDemoCreateGraphicsObject()
{
    Container con = getContentPane();
    con.setBackground(Color.YELLOW);
    con.setLayout(new FlowLayout());
    con.add(moveButton);
    moveButton.addActionListener(this);
    setDefaultCloseOperation(JFrame.EXIT_ON_CLOSE);
    setSize(SIZE, SIZE);
}
```

4. Within the `actionPerformed()` method, you can create a `Graphics` object and use it to draw the `String` on the screen. Each time a user clicks the `JButton`, the `x`- and `y`-coordinates both increase, so a copy of the movie quote appears slightly below and to the right of the previous one. Type the following `actionPerformed()` method to accomplish this processing:

```
public void actionPerformed(ActionEvent e)
{
    Graphics pen = getGraphics();
    pen.setFont(broadwayFont);
    pen.setColor(Color.MAGENTA);
    pen.drawString(movieQuote, x += GAP, y += GAP);
}
```

5. Add a `main()` method to instantiate a `JDemoCreateGraphicsObject` object and give it visibility. Add a closing curly brace for the class.

```
public static void main(String[] args)
{
    JDemoCreateGraphicsObject frame = new
        JDemoCreateGraphicsObject();
    frame.setVisible(true);
}
}
```

6. Save the file as `JDemoCreateGraphicsObject.java`, and then compile and run the program. Click the **Move It** button several times to see the `String` message appear and move on the screen.
7. When you finish clicking the button, close the `JFrame` to end the application.

## Examining Screen Coordinates

If you run `JDemoCreateGraphicsObject` and click the `JButton` enough times, the movie quote `String` appears to march off the bottom of the `JFrame`. Every time you click the `JButton`, the `x`- and `y`-coordinates used by `drawString()` increase, and there is no limit to their value. You can prevent this error by checking the screen coordinates' values to see if they exceed the `JFrame`'s dimensions.

### To avoid the error of exceeding the frame's viewing area:

1. Open the `JDemoCreateGraphicsObject` file, and immediately save it as `JDemoCreateGraphicsObject2`. Change the class name, constructor name, and the two references to the class in the `main()` method to match.
2. Because the screen size is 400 by 400, you can ensure that at least part of the `String` appears in the frame by preventing the `y`-coordinate from exceeding a value that is slightly less than 400. Create a constant to hold this limit by adding the following just after the declaration of `SIZE`:
 

```
final int LIMIT = SIZE - 50;
```
3. In the `actionPerformed()` method, replace the stand-alone call to `drawString()` with one that depends on `LIMIT` as follows:

```
if(y < LIMIT)
    pen.drawString(movieQuote, x += GAP, y += GAP);
```

4. Add an `else` clause that disables the `JButton` after the x-coordinate becomes too large:  

```
else  
    moveButton.setEnabled(false);
```
5. Save the file, compile it, and execute it. Now when you click the **Move It** button, the movie quote moves until the y-coordinate reaches 350, when the `JButton` is disabled; the movie quote no longer violates the frame's size limits.
6. Close the frame to end the program.

## Creating a Drawing

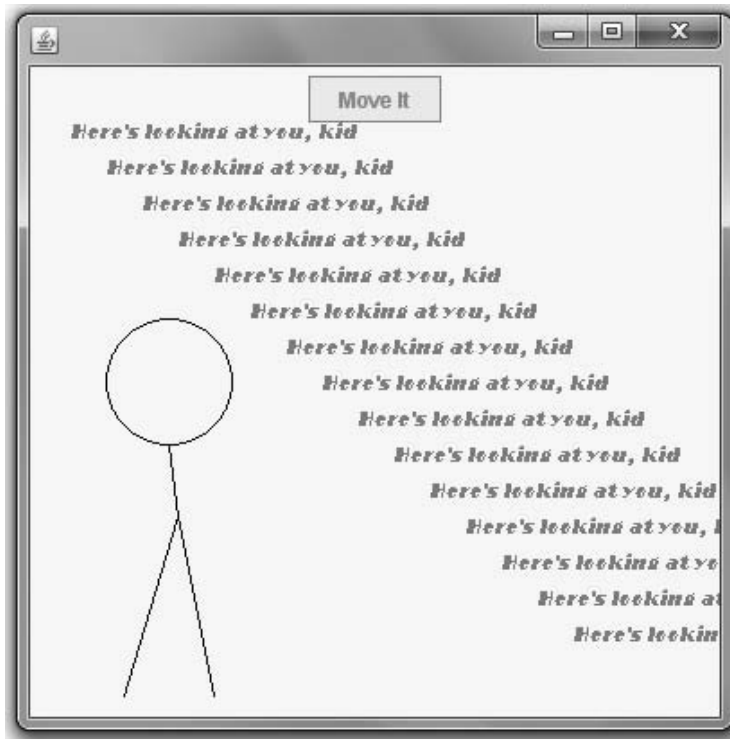
Next, you will add a simple line drawing to the `JDemoCreateGraphicsObject2` program. The drawing will appear after the user clicks the `JButton` enough times to disable the `JButton`.

### To add a line drawing to a `JFrame`:

1. Open the `JDemoCreateGraphicsObject2` file, and immediately save it as `JDemoCreateGraphicsObject3.java`. Change the class name, constructor name, and two references in the `main()` method to match.
2. Replace the current `if...else` structure that tests whether `y` is less than `LIMIT` in the `actionPerformed()` method. Instead, use the following code, which tests the value of `y` and either draws the quote or disables the `JButton` and draws a picture. Set the drawing color to black, and create a simple drawing of a stick person that includes a head, torso, and two legs:

```
if(y < LIMIT)  
    pen.drawString(movieQuote, x += GAP, y += GAP);  
else  
{  
    moveButton.setEnabled(false);  
    pen.setColor(Color.BLACK);  
    pen.drawOval(50, 170, 70, 70);  
    pen.drawLine(85, 240, 90, 280);  
    pen.drawLine(90, 280, 60, 380);  
    pen.drawLine(90, 280, 110, 380);  
}
```

3. Save the file, compile it, and execute it. After the movie quote moves to the `LIMIT` value, the `JButton` is disabled and the drawing appears, as shown in Figure 16-29.



**Figure 16-29** The `JDemoCreateGraphicsObject3` program after the `JButton` is disabled

4. Close the application.
5. Modify the application so the drawing has more details, such as arms, feet, and a simple face. Save the revised application as **`JDemoCreateGraphicsObject4.java`**.

## Copying an Area

Next, you will learn how to copy an area containing a shape that you want to appear several times on a `JFrame`. By copying, you do not have to re-create the shape each time.

### To copy an area:

1. Open a new text file in your text editor, and then enter the beginning statements for a `JFrame` that uses the `copyArea()` method:

```
import javax.swing.*;
import java.awt.*;
import java.awt.Color;
public class JThreeStars extends JFrame
{
```

2. Add the following statements, which create a polygon in the shape of a star:

```
int xPoints[] = {42, 52, 72, 52,
                60, 40, 15, 28, 9, 32, 42};
int yPoints[] = {38, 62, 68, 80,
                105, 85, 102, 75, 58, 60, 38};
Polygon aStar = new Polygon(xPoints, yPoints, xPoints.length);
```

3. Add a constructor that sets the default close operation:

```
public JThreeStars()
{
    setDefaultCloseOperation(JFrame.EXIT_ON_CLOSE);
}
```

4. Add the following paint() method, which sets a color, draws a star, and then draws two additional identical stars:

```
public void paint(Graphics star)
{
    super.paint(star);
    star.setColor(Color.BLUE);
    star.drawPolygon(aStar);
    star.copyArea(0, 0, 75, 105, 80, 40);
    star.copyArea(0, 0, 75, 105, 40, 150);
}
```

5. Add a main() method that instantiates a JThreeStars object and sets its size and visibility. Add a closing brace to end the class:

```
public static void main(String[] args)
{
    JThreeStars frame = new JThreeStars();
    frame.setSize(200, 300);
    frame.setVisible(true);
}
}
```

6. Save the file as **JThreeStars.java**, and then compile the program. When you run the program, the output looks like Figure 16-30.
7. Close the frame to end the application.
8. Modify the program to add two more stars in any location you choose, save and compile the program, and confirm that the stars are copied to your desired locations.



**Figure 16-30** Output of the JThreeStars program with one star

## Using FontMetrics Methods to Compare Fonts

Next, you will write a program to demonstrate FontMetrics methods. You will create three Font objects and display their metrics.

### To demonstrate FontMetrics methods:

805

1. Open a new text file in your text editor, and then enter the first few lines of the JDemoFontMetrics program:

```
import javax.swing.*;
import java.awt.*;
public class JDemoFontMetrics extends JFrame
{
```

2. Type the following code to create a String and a few fonts to use for demonstration purposes:

```
String movieQuote =
    new String("Go ahead, make my day");
Font courierItalic = new Font("Courier New", Font.ITALIC, 16),
    timesPlain = new Font("Times New Roman", Font.PLAIN, 16),
    scriptBold = new Font("Freestyle Script", Font.BOLD, 16);
```

3. Add the following code to define four integer variables to hold the four font measurements, and two integer variables to hold the current horizontal and vertical output positions within the JFrame:

```
int ascent, descent, height, leading;
int x = 20, y = 50;
```

4. Within the JFrame, you will draw Strings positioned 40 pixels apart vertically. After each of those Strings, the Strings that hold the statistics will be 15 pixels apart. Type the following statements to create constants to hold these vertical increase values:

```
final int INCREASE_SMALL = 15;
final int INCREASE_LARGE = 40;
```

5. Add a constructor as follows:

```
public JDemoFontMetrics()
{
    setDefaultCloseOperation(JFrame.EXIT_ON_CLOSE);
}
```

6. Add the following statements to start writing a paint() method. Within the method, you set the Font to courierItalic, draw the movieQuote String to show a working example of the font, and then call a displayMetrics() method that you will write in Step 7. Pass the Graphics object to the displayMetrics() method, so the method can discover the sizes associated with the current font. Perform the same three steps using the timesPlain and scriptBold fonts.

```

public void paint(Graphics pen)
{
    super.paint(pen);
    pen.setFont(courierItalic);
    pen.drawString(phrase, x, y);
    displayMetrics(pen);
    pen.setFont(timesPlain);
    pen.drawString(movieQuote, x, y += INCREASE_LARGE);
    displayMetrics(pen);
    pen.setFont(scriptBold);
    pen.drawString(movieQuote, x, y += INCREASE_LARGE);
    displayMetrics(pen);
}

```

7. Next, add the header and opening curly brace for the `displayMetrics()` method. The method will receive a `Graphics` object from the `paint()` method. Add the following statements to call the four `getFontMetrics()` methods to obtain values for the leading, ascent, descent, and height variables:

```

public void displayMetrics(Graphics metrics)
{
    leading = metrics.getFontMetrics().getLeading();
    ascent = metrics.getFontMetrics().getAscent();
    descent = metrics.getFontMetrics().getDescent();
    height = metrics.getFontMetrics().getHeight();
}

```

8. Add the following four `drawString()` statements to display the values. Use the expression `y += INCREASE_SMALL` to change the vertical position of each `String` by the constant. Add a closing curly brace for the method.

```

metrics.drawString("Leading is " + leading,
    x, y += INCREASE_SMALL);
metrics.drawString("Ascent is " + ascent,
    x, y += INCREASE_SMALL);
metrics.drawString("Descent is " + descent,
    x, y += INCREASE_SMALL);
metrics.drawString("Height is " + height,
    x, y += INCREASE_SMALL);
}

```

9. Add a `main()` method, and include a closing curly brace for the class:

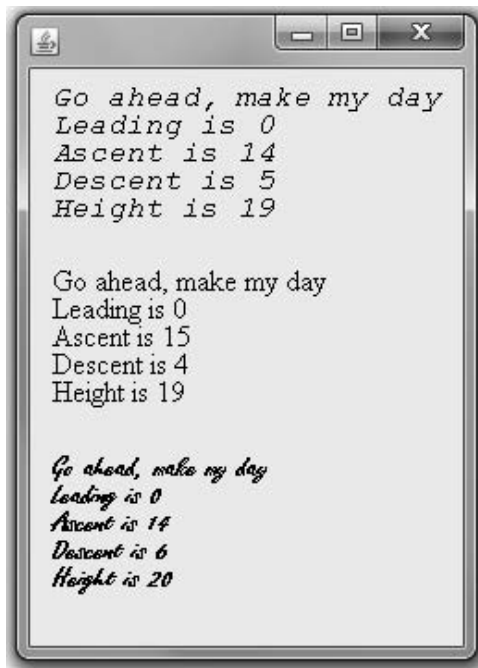
```

public static void main(String[] args)
{
    JDemoFontMetrics frame = new JDemoFontMetrics();
    frame.setSize(250, 350);
    frame.setVisible(true);
}
}

```

10. Save the file as `JDemoFontMetrics.java`, and then compile it. When you run the program, the output should look like Figure 16-31. Notice that even though each `Font` object was constructed with a size of 16, the individual statistics vary for each `Font` object.





**Figure 16-31** Output of the `JDemoFontMetrics` program

11. Close the frame to end the program.

## Using `FontMetrics` Methods to Place a Border Around a String

Next, you will use the `FontMetrics` methods to draw a rectangle around a `String`. Instead of guessing at appropriate pixel positions, you can use the height and width of the `String` to create a box with borders placed symmetrically around the `String`.

### To draw a rectangle around a String:

1. Open a new file in your text editor, and enter the first few lines of a `JBoxAround` `JFrame`:
 

```
import javax.swing.*;
import java.awt.*;
public class JBoxAround extends JFrame
{
```
2. Enter the following statements to add a `String`, a `Font`, and variables to hold the font metrics and x- and y-coordinates:

```
String movieQuote =
    new String("An offer he can't refuse");
Font serifItalic = new Font("Serif", Font.ITALIC, 20);
int leading, ascent, height, width;
int x = 40, y = 60;
```

3. Create the following named constant that holds a number of pixels indicating the dimensions of the rectangle that you draw around the `String`:

```
static final int BORDER = 5;
```

4. Add a constructor as follows:

```
public JBoxAround()  
{  
    setDefaultCloseOperation(JFrame.EXIT_ON_CLOSE);  
}
```

5. Add the following `paint()` method, which sets the font, draws the `String`, and obtains the font metrics:

```
public void paint(Graphics gr)  
{  
    super.paint(gr);  
    gr.setFont(serifItalic);  
    gr.drawString(movieQuote, x, y);  
    Leading = gr.getFontMetrics().getLeading();  
    ascent = gr.getFontMetrics().getAscent();  
    height = gr.getFontMetrics().getHeight();  
    width = gr.getFontMetrics().stringWidth(movieQuote);  
}
```

6. Draw a rectangle around the `String` using the following `drawRect()` method. In Figure 16-32, the  $x$ - and  $y$ -coordinates of the upper-left edge are set at  $x - \text{BORDER}$ ,  $y - (\text{ascent} + \text{leading} + \text{BORDER})$ . The proper width and height are then determined to draw a uniform rectangle around the string.

The values of the  $x$ - and  $y$ -coordinates used in the `drawString()` method indicate the left side of the baseline of the first character in the `String`. You want to position the upper-left corner of the rectangle five pixels to the left of the `String`, so the first argument to `drawRect()` is 5 less than  $x$ , or  $x - \text{BORDER}$ . The second argument to `drawRect()` is the  $y$ -coordinate of the `String` minus the ascent of the `String`, minus the leading of the `String`, minus 5, or  $y - (\text{ascent} + \text{leading} + \text{BORDER})$ . The final two arguments to `drawRect()` are the width and height of the rectangle. The width is the `String`'s width plus five pixels on the left and five pixels on the right. The height of the rectangle is the `String`'s height, plus five pixels above the `String` and five pixels below the `String`.

```
    gr.drawRect(x - BORDER, y - (ascent + leading + BORDER),  
        width + 2 * BORDER, height + 2 * BORDER);  
}
```

7. Add the following `main()` method and a closing brace for the class:

```
public static void main(String[] args)  
{  
    JBoxAround frame = new JBoxAround();  
    frame.setSize(330, 100);  
    frame.setVisible(true);  
}  
}
```

- Save the file as **JBoxAround.java**. Compile and execute it. Your output should look like Figure 16-32.



**Figure 16-32** Output of the JBoxAround program

- Experiment with changing the contents of the `String`, the `x` and `y` starting coordinates, and the value of the `BORDER` constant. Confirm that the rectangle is drawn symmetrically around any `String` object.

## Using Drawing Strokes

Next, you will create a line with a drawing stroke to illustrate how it can have different end types and juncture types where lines intersect.

### To create a line with a drawing stroke:

- Open a new file in your text editor, and then enter the first few lines of a `J2DLine` `JFrame`. (Note that you are importing the `java.awt.geom` package.)

```
import javax.swing.*;
import java.awt.*;
import java.awt.geom.*;
public class J2DLine extends JFrame
{
```

- Add a constructor:

```
public J2DLine()
{
    setDefaultCloseOperation(JFrame.EXIT_ON_CLOSE);
}
```

- Enter the following statements to create a `paint()` method, create a `Graphics` environment `gr`, and cast the `Graphics` environment to a `Graphics2D` environment `gr2D`. Create `x`- and `y`-points with the `Point2D.Float` class.

```
public void paint(Graphics gr)
{
    super.paint(gr);
    Graphics2D gr2D = (Graphics2D)gr;
    Point2D.Float pos1 = new Point2D.Float(80, 50);
    Point2D.Float pos2 = new Point2D.Float(20, 100);
```

4. Create a `BasicStroke` object, and then create a drawing stroke named `aStroke`. Note that the line width is set to 15 pixels, and the endcap style and juncture style are set to `CAP_ROUND` and `JOIN_MITER`, respectively.

```
BasicStroke aStroke = new BasicStroke(15.0f,  
    BasicStroke.CAP_ROUND, BasicStroke.JOIN_MITER);
```

5. Add the following code to create a line between the points `pos1` and `pos2`, and draw the line. Add a closing curly brace for the method.

```
gr2D.setStroke(aStroke);  
Line2D.Float line = new Line2D.Float(pos1, pos2);  
gr2D.draw(line);  
}
```

6. Add a `main()` method and the closing curly brace for the class:

```
public static void main(String[] args)  
{  
    J2DLine frame = new J2DLine();  
    frame.setSize(100, 120);  
    frame.setVisible(true);  
}
```

7. Save the file as `J2DLine.java`, then compile and execute it. Your output should look like Figure 16-33.
8. Experiment by making the `JFrame` size larger and adding more lines to create an interesting design.



**Figure 16-33** Output of the `J2DLine` program

## Working with Shapes

Next, you will use the Java 2D drawing object types to create a `JFrame` that illustrates sample rectangles, ovals, arcs, and polygons.

### To create the `JShapes2D JFrame`:

1. Open a new file in your text editor, and then enter the first few lines of a `JShapes2D JFrame`:

```
import javax.swing.*;  
import java.awt.*;  
import java.awt.geom.*;  
public class JShapes2D extends JFrame  
{
```

2. Add a constructor that sets the default close operation as follows:

```
public JShapes2D()  
{  
    setDefaultCloseOperation(JFrame.EXIT_ON_CLOSE);  
}
```

3. Enter the following statements to create a `paint()` method, create a `Graphics` environment `gr`, and cast the `Graphics` environment to a `Graphics2D` environment `gr2D`:

```
public void paint(Graphics gr)
{
    super.paint(gr);
    Graphics2D gr2D = (Graphics2D)gr;
```

4. Create two `Rectangle2D.Float` objects named `rect` and `rect2`. Draw the `rect` object and fill the `rect2` object:

```
Rectangle2D.Float rect =
    new Rectangle2D.Float(20F, 40F, 40F, 40F);
Rectangle2D.Float rect2 =
    new Rectangle2D.Float(20F, 90F, 40F, 40F);
gr2D.draw(rect);
gr2D.fill(rect2);
```

5. Create two `Ellipse2D.Float` objects named `ellipse` and `ellipse2`. Draw the `ellipse` object and fill the `ellipse2` object:

```
Ellipse2D.Float ellipse = new
    Ellipse2D.Float(20F, 140F, 40F, 40F);
Ellipse2D.Float ellipse2 = new
    Ellipse2D.Float(20F, 190F, 40F, 40F);
gr2D.draw(ellipse);
gr2D.fill(ellipse2);
```

6. Create two `Arc2D.Float` objects named `ac` and `ac2`. Draw the `ac` object and fill the `ac2` object:

```
Arc2D.Float ac = new
    Arc2D.Float(20, 240, 50, 50, 30, 120, Arc2D.PIE);
Arc2D.Float ac2 = new
    Arc2D.Float(20, 290, 50, 50, 30, 120, Arc2D.PIE);
gr2D.draw(ac);
gr2D.fill(ac2);
```

7. Create a new `GeneralPath` object named `po1`. Set the starting point of the polygon and create two additional points. Use the `closePath()` method to close the polygon by connecting the current point to the starting point. Draw the `po1` object, then end the method with a curly brace:

```
GeneralPath po1 = new GeneralPath();
po1.moveTo(20F, 320F);
po1.lineTo(40F, 380F);
po1.lineTo(100F, 400F);
po1.closePath();
gr2D.draw(po1);
}
```

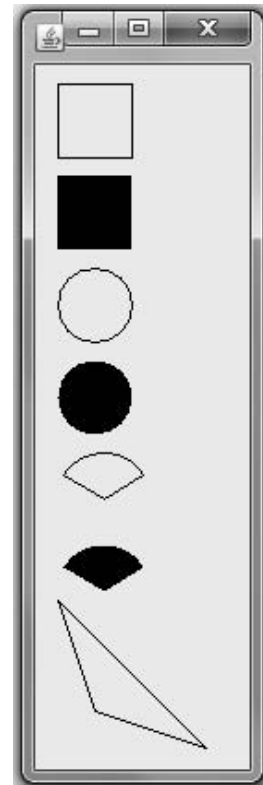
8. Add a `main()` method and the final curly brace for the class:

```
public static void main(String[] args)
{
    JShapes2D frame = new JShapes2D();
    frame.setSize(100, 420);
    frame.setVisible(true);
}
}
```

9. Save the file as `JShapes2D.java`, and compile and execute the program. Your output should look like Figure 16-34. When you are ready, close the window, then experiment with making changes to the program to produce different shapes.

## Don't Do It

- Don't forget to call `super.paint()` as the first statement in the `paint()` method when you write a class that extends `JFrame`. Failing to do so can cause odd results, especially when you combine GUI widgets with graphics.
- Don't forget that the `setLocation()` method works correctly only when it is used after the layout manager has finished positioning all the application's components (or in cases where no layout manager is functioning).
- Don't forget that the lower-left corner of a `String` is placed at the coordinates used when you call `drawString()`.



**Figure 16-34** Output of the `JShapes2D` program

## Key Terms

When a drawing is **rerendered**, it is repainted or redisplayed.

Redisplaying a surface also is called **painting**.

**System-triggered painting** operations occur when the system requests a component to render its contents.

**Application-triggered painting** operations occur when the internal state of a component has changed.

The **paint()** method runs when Java displays a screen; you can write your own **paint()** method to override the automatically supplied one whenever you want to paint graphics such as shapes on the screen.

The **Graphics class** is an abstract class that descends directly from **Object** and holds data about graphics operations and methods for drawing shapes, text, and images.

You call the **repaint()** method when a window needs to be updated, such as when it contains new images.

The **setLocation()** method allows you to place a component at a specific location within a **JFrame**'s content pane.

The **drawString()** method allows you to draw a **String** in a **JFrame** or other component.

The **drawLine()** method draws a straight line between any two points on the screen.

The **drawRect()** method draws the outline of a rectangle.

The **fillRect()** method draws a solid, or filled, rectangle.

The **clearRect()** method draws a rectangle using the background color to create what appears to be an empty or “clear” rectangle.

The **drawRoundRect()** method draws rectangles with rounded corners.

An **arc** is a portion of a circle.

You use the **draw3DRect()** method to draw a rectangle that appears to have “shadowing” on two of its edges—the effect is that of a rectangle that is lit from the upper-left corner and slightly raised or slightly lowered.

You use the **fill3DRect()** method to create filled, 3D rectangles.

The **drawOval()** method draws an oval.

The **fillOval()** method draws a solid, filled oval.

The **drawArc()** method draws an arc.

The **fillArc()** method creates a solid arc.

The **drawPolygon()** method draws complex shapes.

The **fillPolygon()** method draws a solid shape.

The **addPoint()** method adds points to a **Polygon** object.

The **copyArea()** method copies any rectangular area to a new location.

The **getAvailableFontFamilyNames()** method returns the fonts that are available on your system.

The **getDefaultToolkit()** method provides information about the system in use.

The **getScreenResolution()** method returns the screen resolution on the current system.

The **getScreenSize()** method returns the screen size as a `Dimension` object.

**Ascent** is one of three measures of a `Font`'s height; it is the height of an uppercase character from a baseline to the top of the character.

**Descent** is one of three measures of a `Font`'s height; it measures the part of characters that “hang below” the baseline, such as the tails on the lowercase letters *g* and *j*.

**Leading** is one of three measures of a `Font`'s height; it is the amount of space between the bottom of the descent of one line and the top of the characters in the successive line of type.

The **height of a font** is the sum of its leading, ascent, and descent.

You can discover a `Font`'s height by using the `Graphics` class **getFontMetrics()** method to return a `FontMetrics` object, and then using one of the following: `public int getLeading()`, `public int getAscent()`, `public int getDescent()`, or `public int getHeight()`.

The `FontMetrics` class contains a **stringWidth()** method that returns the integer width of a `String`.

The **Graphics2D** class provides tools for 2D drawing.

**Fill patterns** control how a drawing object is filled in.

A **gradient fill** is a gradual shift from one color at one coordinate point to a different color at a second coordinate point.

An **acyclic gradient** is a fill pattern in which a color shift occurs once between two points.

A **cyclic gradient** is a fill pattern in which a shift between colors occurs repeatedly between two points.

A **stroke** is a line-drawing feature in Java 2D that represents a single movement as if you were using a drawing tool, such as a pen or a pencil.

The **setStroke()** method changes a stroke's width in Java 2D.

**BasicStroke** is the class that defines line types and implements the `Stroke` interface.

**Endcap styles** apply to the ends of lines that do not join with other lines, and include `CAP_BUTT`, `CAP_ROUND`, and `CAP_SQUARE`.

**Juncture styles**, for lines that join, include `JOIN_MITER`, `JOIN_ROUND`, and `JOIN_BEVEL`.

## Chapter Summary

- Painting operations can be system triggered or application triggered. Painting operations are performed by a `Component`'s `paint()` method, which takes a `Graphics` argument that renders output. You override the `paint()` method in your programs when you want specific actions to take place when components must be rendered. The `setLocation()` method allows you to place a component at a specific location within a `JFrame`'s content pane.



- The `drawString()` method allows you to draw a `String`. The method requires three arguments: a `String`, an x-axis coordinate, and a y-axis coordinate. The `drawString()` method is a member of the `Graphics` class, so you need to use a `Graphics` object to call it. You can improve the appearance of strings drawn using `Graphics` objects by using the `setFont()` and `setColor()` methods.
- Java provides you with several methods for drawing a variety of lines and geometric shapes, such as `drawLine()`, `drawRect()`, `drawOval()`, `drawPolygon()`, and others. You can also use the `copyArea()` method to copy any rectangular area to a new location.
- If a user's computer does not have a requested font, Java chooses a default replacement font, so you can never be completely certain how your output will look. You can discover the fonts that are available on your system by using the `getAvailableFontFamilyNames()` method, which is part of the `GraphicsEnvironment` class. This class describes the collection of `Font` objects and `GraphicsDevice` objects available to a Java application on a particular platform. You can discover the resolution and screen size on your system by using the `getScreenResolution()` and `getScreenSize()` methods, which are part of the `Toolkit` class. The height of every font is the sum of three parts: ascent, descent, and leading. A practical use for discovering the height of a font is to space `Strings` correctly as you display them.
- You can call drawing operations using a `Graphics2D` object. The advantage of using Java 2D objects is the higher-quality, 2D graphics, images, and text they provide. With 2D you can designate attributes such as line width and fill patterns.

## Review Questions

1. Repainting of a visible surface is triggered by \_\_\_\_\_.
  - a. the operating system
  - b. the application
  - c. either of these
  - d. none of these
2. The method that calls the `paint()` method for you is \_\_\_\_\_.
  - a. `callPaint()`
  - b. `repaint()`
  - c. `requestPaint()`
  - d. `draw()`
3. The `paint()` method header requires a(n) \_\_\_\_\_ argument.
  - a. `void`
  - b. `integer`
  - c. `String`
  - d. `Graphics`
4. The `setLocation()` method \_\_\_\_\_.
  - a. is used to position a `JFrame` on the screen
  - b. is used to set regional and national preferences for an application
  - c. takes two integer arguments that represent position coordinates
  - d. must be used with every component placed on a `JFrame`

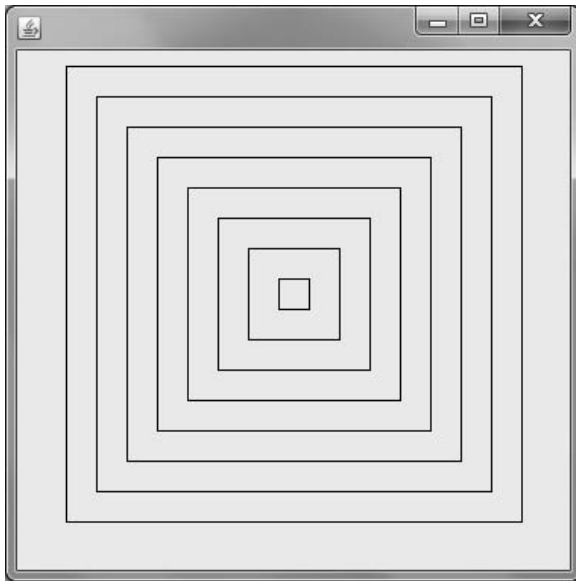
5. The statement `g.drawString(someString, 50, 100);` places `someString`'s \_\_\_\_\_ corner at position 50, 100.
  - a. upper-left
  - b. lower-left
  - c. upper-right
  - d. lower-right
6. If you use the `setColor()` method to change a `Graphics` object's color to yellow, \_\_\_\_\_.
  - a. only the next output from the object appears in yellow
  - b. all output from the object for the remainder of the method always appears in yellow
  - c. all output from the object for the remainder of the application always appears in yellow
  - d. all output from the object appears in yellow until you change the color
7. The correct statement to instantiate a `Graphics` object named `picasso` is \_\_\_\_\_.
  - a. `Graphics picasso;`
  - b. `Graphics picasso = new Graphics();`
  - c. `Graphics picasso = getGraphics();`
  - d. `Graphics picasso = getGraphics(new);`
8. The statement `g.drawRoundRect(100, 100, 100, 100, 0, 0);` draws a shape that looks most like a \_\_\_\_\_.
  - a. square
  - b. round-edged rectangle
  - c. circle
  - d. straight line
9. If you draw an oval with the same value for width and height, you draw a(n) \_\_\_\_\_.
  - a. circle
  - b. square
  - c. rounded square
  - d. ellipsis
10. The zero-degree position for any arc is at the \_\_\_\_\_ o'clock position.
  - a. three
  - b. six
  - c. nine
  - d. twelve
11. The method you use to create a solid arc is \_\_\_\_\_.
  - a. `solidArc()`
  - b. `fillArc()`
  - c. `arcSolid()`
  - d. `arcFill()`
12. You use the \_\_\_\_\_ method to copy any rectangular area to a new location.
  - a. `copyRect()`
  - b. `copyArea()`
  - c. `repeatRect()`
  - d. `repeatArea()`

13. The measurement of an uppercase character from the baseline to the top of the character is its \_\_\_\_\_.
- a. ascent
  - b. descent
  - c. leading
  - d. height
14. To be certain that a vertical series of Strings has enough room to appear in a frame, you use which of the following statements?
- a. `g.drawString("Some string", x, y += g.getFontMetrics().getHeight());`
  - b. `g.drawString("Some string", x, y += g.getFontMetrics().getLeading());`
  - c. `g.drawString("Some string", x, y += g.getFontMetrics().getAscent());`
  - d. `g.drawString("Some string", x, y += g.getFontMetrics().getDescent());`
15. You can discover the fonts that are available on your system by using the \_\_\_\_\_.
- a. `getAvailableFontFamilyNames()` method of the `GraphicsEnvironment` class
  - b. `getFonts()` method of the `Graphics` class
  - c. `getMyFonts()` method of the `GraphicsFonts` class
  - d. `getAllFonts()` method of the `Fonts` class
16. The `getScreenResolution()` method and `getScreenSize()` method \_\_\_\_\_.
- a. both return the number of pixels as an `int` type
  - b. respectively return the number of pixels as an `int` type and an object of type `Dimension`
  - c. both return an object of type `Dimension`
  - d. respectively return the number of pixels as a `double` type and an object of type `Dimension`
17. A `Graphics2D` object is produced by \_\_\_\_\_.
- a. the `setGraphics2D()` method
  - b. the `Graphics2D newpen = Graphics2D()` statement
  - c. the `Graphics2D = Graphics(g)` statement
  - d. casting a `Graphics` object
18. The process of drawing with Java 2D objects includes \_\_\_\_\_.
- a. specifying the rendering attributes
  - b. setting a drawing stroke
  - c. both of the above
  - d. none of the above

19. A gradient fill is a gradual change in \_\_\_\_\_.
- a. color
  - b. font size
  - c. drawing style
  - d. line thickness
20. With the 2D methods, the drawing line is a \_\_\_\_\_.
- a. brush
  - b. stroke
  - c. belt
  - d. draw

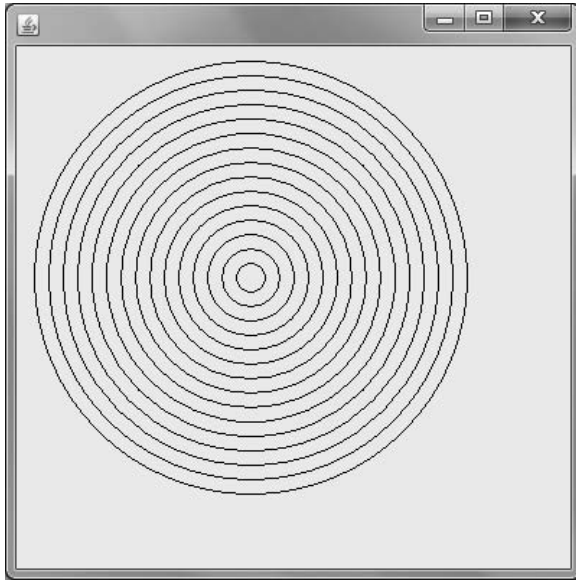
## Exercises

1. Write an application that extends `JFrame` and that displays your first name in every even-numbered font size from 4 through 24. Save the file as **JFontSizeDemo.java**.
2. Write an application that extends `JFrame` and that displays your name in blue the first time the user clicks a `JButton`. The second time the user clicks the `JButton`, make the first name seem to disappear. (*Hint*: Redraw it using the background color.) At the same time, draw your first name again in a larger font in dark gray. Save the file as **JBlueGray.java**.
3. Write an application that extends `JFrame` and that displays eight nested rectangles, like those in Figure 16-35. You may use only one `drawRect()` statement in the program. (*Hint*: Use it in a loop.) Save the file as **JNestedBoxes.java**.



**Figure 16-35** Output of the `JNestedBoxes` program

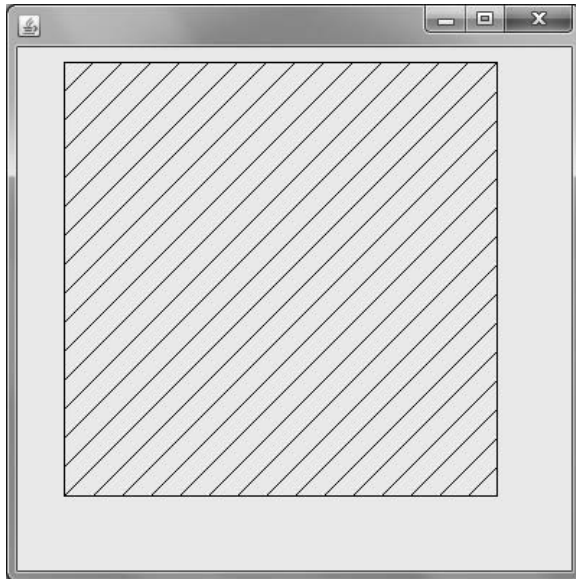
- Write an application that extends `JFrame` and that displays 15 nested circles, like those in Figure 16-36. You may use only one `drawOval()` statement in the program. Save the file as **`JNestedCircles.java`**.



819

**Figure 16-36** Output of the `JNestedCircles` program

- Write an application that extends `JFrame` and that displays diagonal lines in a square, like those in Figure 16-37. Save the file as **`JDiagonalLines.java`**.



**Figure 16-37** Output of the `JDiagonalLines` program

6. Write an application that extends `JFrame` and that displays a form for creating an e-mail directory. The form should contain three `JLabels` that describe three `JTextFields` for first name, last name, and e-mail address. After the user enters the third item (an e-mail address) and presses Enter, the frame should display the information that was entered. Use the `drawString()` method to display a heading line, such as “The e-mail information you entered is:”, followed by the e-mail information. Save the file as **`JEmailForm.java`**.
7.
  - a. Write an application that extends `JFrame` and that displays a yellow smiling face on the screen. Save the file as **`JSmileFace.java`**.
  - b. Add a `JButton` to the `JSmileFace` program so the smile changes to a frown when the user clicks the `JButton`. Save the file as **`JSmileFace2.java`**.
8.
  - a. Use polygons and lines to create a graphics image that looks like a fireworks display. Write an application that extends `JFrame` and that displays the fireworks. Save the file as **`JFireworks.java`**.
  - b. Add a `JButton` to the `JFireworks` program. Do not show the fireworks until the user clicks the `JButton`. Save the file as **`JFireworks2.java`**.
9.
  - a. Write an application that extends `JFrame` and that displays your name. Place boxes around your name at intervals of 10, 20, 30, and 40 pixels. Save the file as **`JBorders.java`**.
  - b. Make each of the four borders display a different color in the `JBorders` program. Save the file as **`JBorders2.java`**.
10. Write an application that extends `JFrame` and that prompts the user to enter his or her name and weight in pounds. After the name and weight are entered, use `Graphics2D` methods to display the user’s name and weight, with the weight displayed in pounds, ounces, kilograms, and metric tons on separate lines. Use the following conversion factors:
  - ♦ 1 pound = 16 ounces
  - ♦ 1 kilogram = 1 pound / 2.204623
  - ♦ 1 metric ton = 1 pound / 2204.623Save the file as **`JCalculateWeight.java`**.
11. Write an application that extends `JFrame` and that uses the `Graphics2D` environment to create a `GeneralPath` object. Use the `GeneralPath` object to create the outline of your favorite state. Display the state name at the approximate center of the state boundaries. Save the file as **`JFavoriteState.java`**.
12. Write an application that extends `JFrame` and that draws a realistic-looking stop sign. Save the file as **`JStopSign.java`**.
13. Write an application that displays a `JFrame` that does the following:
  - ♦ Turns yellow when the user’s mouse enters the frame
  - ♦ Turns black when the user’s mouse exits the frame

- Displays a larger circle at the point where the user left-clicks
- Displays a smaller circle at the point where the user right-clicks

At most, one circle should appear on the surface of the frame at a time. Save the file as **JMouseFrame.java**.



## Debugging Exercise

14. Each of the following files in the Chapter.16 folder of your downloadable student files has syntax and/or logic errors. In each case, determine the problem and fix the program. After you correct the errors, save each file using the same filename preceded with Fix. For example, DebugSixteen1.java will become FixDebugSixteen1.java.
- DebugSixteen1.java
  - DebugSixteen2.java
  - DebugSixteen3.java
  - DebugSixteen4.java



## Game Zone

15. a. In Chapter 9, you created a Tic Tac Toe game in which you used a 2D array of characters to hold Xs and Os for a player and the computer. Now create a JFrame that uses an array of nine JButtons to represent the Tic Tac Toe grid. When the user clicks a JButton that has not already been taken, place an X on the button and then allow the computer to place an O on a different button. Announce the winner when either the computer or the player achieves three marks in sequence, or announce that the game was a tie. Figure 16-38 shows a typical game in progress and after the player has won. Save the game as **JTicTacToe.java**.



**Figure 16-38** Typical execution of JTicTacToe program

- b. Add a graphic that displays a large letter representing the winning player of the game in Game Zone exercise 15a. Draw a large *X*, *O*, or, in case of a tie, an overlapping *X* and *O* in different colors. Save the game as **JTicTacToe2.java**.

16. Create an application that plays a card game named Lucky Seven. In real life, the game can be played with seven cards, each containing a number from 1 through 7, that are shuffled and dealt number-side down. To start the game, a player turns over any card. The exposed number on the card determines the position (reading from left to right) of the next card that must be turned over. For example, if the player turns over the first card and its number is 7, the next card turned must be the seventh card (counting from left to right). If the player turns over a card whose number denotes a position that was already turned, the player loses the game. If the player succeeds in turning over all seven cards, the player wins.

Instead of cards, you will use seven buttons labeled 1 through 7 from left to right. Randomly associate one of the seven values 1 through 7 with each button. (In other words, the associated value might or might not be equivalent to the button's labeled value.) When the player clicks a button, reveal the associated hidden value. If the value represents the position of a button already clicked, the player loses. If the revealed number represents an available button, force the user to click it; that is, do not take any action until the user clicks the correct button. After a player clicks a button, remove the button from play. (After you remove a button, you can call `repaint()` to ensure that the image of the button is removed.)

For example, a player might click Button 7, revealing a 4. Then the player clicks Button 4, revealing a 2. Then the player clicks Button 2, revealing a 7. The player loses because Button 7 was already used. Save the game as **JLuckySeven.java**.

17. a. In Chapters 7 and 8, you created a game named Secret Phrase in which the user guesses a randomly selected secret phrase by entering one letter at a time. Now create a GUI application that plays the game, allowing users to choose a letter by selecting one of 26 buttons. (*Hint*: Consider creating an array of buttons rather than 26 individually named buttons.)

Disable a letter button once it has been guessed, and after the puzzle is complete, disable all the letters. Figure 16-39 shows a typical execution (1) after the user has guessed an *A*, which is in the phrase; (2) after the user has guessed a *D*, which is not in the phrase; and (3) after the user has completed the puzzle. Save the file as **JSecretPhrase.java**.

- b. Make the `JSecretPhrase` game more like the traditional letter-guessing game Hangman by drawing a “hanged” person piece by piece with each missed letter. For example, when the user chooses a correct letter, place it in the appropriate position or positions in the phrase, but the first time the user chooses a letter that is not in the target phrase, draw a head for the “hanged” man. The second time the user makes an incorrect guess, add a torso. Continue with arms and legs. If the complete body is drawn before the user has guessed all the letters in the phrase, display a message indicating that the player has lost the game. If the user completes the phrase before all the body parts are drawn, display a message that the player has won. Save the game as **JSecretPhrase2.java**.



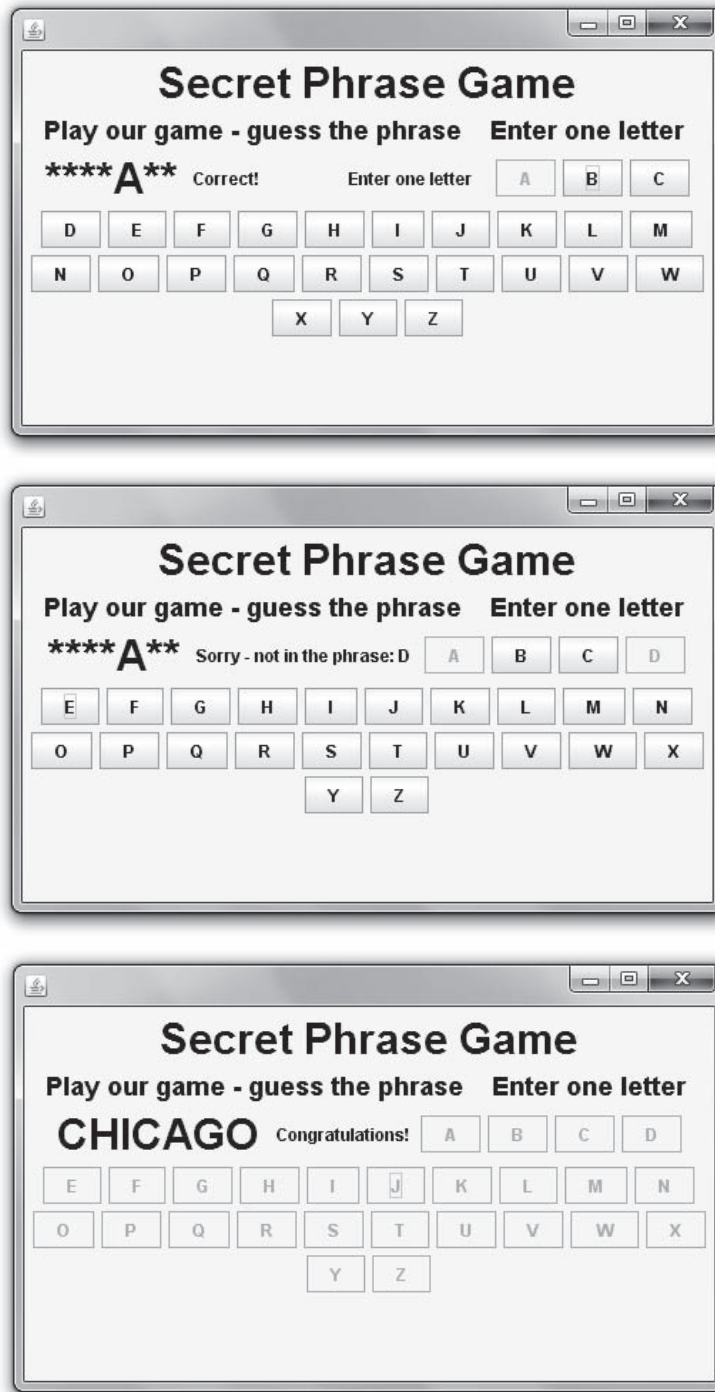


Figure 16-39 Typical execution of JSecretPhrase program

*This page intentionally left blank*

# Applets, Images, and Sound

In this chapter, you will:

- ⦿ Learn about applets
- ⦿ Write an HTML document to host an applet
- ⦿ Create a `JApplet` that contains an `init()` method
- ⦿ Work with `JApplet` components
- ⦿ Understand the `JApplet` life cycle
- ⦿ Understand multimedia and use images
- ⦿ Add sound to `JApplets`

## Introducing Applets

An **applet** is a program that is called within another application—often a Web browser. It can contain any number of components, such as buttons, text fields, and pictures, and it can respond to user-initiated events, such as mouse clicks or keyboard presses. Many of an applet's behaviors come from methods that reside in a Java class named `JApplet`—the programmer can create additional behaviors. The name *applet* means “little application.” An applet is “little” in that it is not a full-blown program, but relies on other programs to execute it.

A Java applet is like a Java application in several ways:

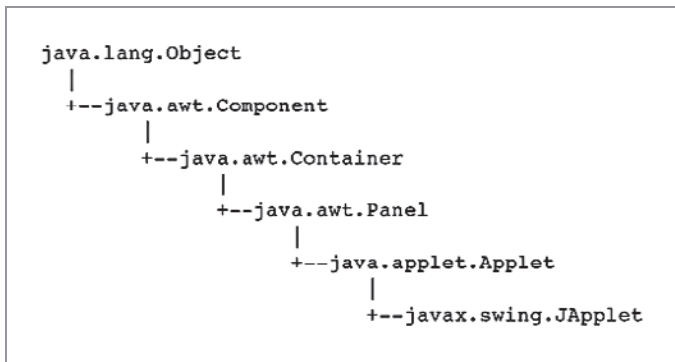
- You save both applets and applications with a `.java` file extension.
- You compile both applets and applications into bytecode using the `javac` command, and the bytecode is stored in a file with a `.class` file extension.
- Both applets and applications can contain any number of methods you define and any number of variables and constants. Both can contain decisions, loops, arrays, and all the other language elements you have learned about in Java.
- Both can (and applets almost always do) contain GUI elements such as buttons and labels, and event listeners that respond to user-initiated actions.

An applet also is different from an application in several ways:

- Unlike applications, applets descend from the `JApplet` class.
- Unlike applications, applets run from another application. You do not use the `java` command to execute an applet.
- Unlike applications, applets do not contain a `main()` method. In this chapter, you will learn about the methods every applet contains.
- Unlike an application that uses a `JFrame`, you do not set a default close operation for a `JApplet`.
- Applets cannot delete, read, or create files on the user's system.
- Applets cannot run any other program on the user's system.

## Understanding the `JApplet` Class

`JApplet` is a Swing class from which you can inherit. A `JApplet` is a `Component`, and it is also a `Container`. Figure 17-1 shows the relationship of `JApplet` to its ancestors. When you create a `JApplet`, you gain access to over 200 methods through inheritance.



**Figure 17-1** Inheritance hierarchy of the `JApplet` class

You can import the `JApplet` class to a program by using one of the following statements:

```
import javax.swing.JApplet;
import javax.swing.*;
```

## Running an Applet

To view an applet, it must be called from another document; frequently the document is written in HTML. **HTML**, or **Hypertext Markup Language**, is a simple language used to create Web pages for the Internet. HTML contains many commands that allow you to format text on a Web page, import graphic images, and link your page to other Web pages. You run applets within a page on the Internet, an intranet, or a local computer.



The current version of HTML is **Extensible Hypertext Markup Language (XHTML)**. The differences are minor, although XHTML is stricter. Most Web developers are continuing to use HTML until XHTML matures and some compatibility issues are resolved. You can find more information and tutorials on both HTML and XHTML at [www.w3schools.com](http://www.w3schools.com).

You can run an applet in one of two ways:

- You can run an applet in a Web browser, such as Internet Explorer, Firefox, Opera, or Safari. To do so, you open the applet-hosting HTML document in the browser. For example, in Internet Explorer, you click File on the menu bar, click Open, and type the complete path for the HTML document that you created. After you press Enter, the applet appears on your screen. The applet can be run within a page on the Internet or an intranet, but you do not have to connect to the Internet to run an applet in your browser—you can simply use the browser locally.
- You can also view your applet on a local computer by using the **Applet Viewer**, which is a program that comes with the Java Development Kit (JDK) and provides a convenient environment in which to test your applets. To use the Applet Viewer, type the **appletviewer command** at the command line, followed by the full HTML filename, including the extension. When you press Enter, the Applet Viewer window opens and displays the applet.



When you save an HTML file, you can use .html or .htm as a file extension. In some older versions of DOS and Windows, filename extensions were not allowed to be more than three characters. Current Web browsers and servers accept files with .htm and .html extensions. Examples in this book use the four-character .html extension.

## TWO TRUTHS & A LIE

### Introducing Applets

1. An applet can contain any number of components, such as buttons, text fields, and pictures, and can respond to user-initiated events, such as mouse clicks or keyboard presses.
2. Applets and applications are similar in that both have .java file extensions and you compile both with the javac command.
3. Applets and applications are different in that applets do not use loops and arrays.

The false statement is #3. Applets use all the language constructs in Java.

## Writing an HTML Document to Host an Applet

When you create an applet, you do the following:

- Write the applet in Java and save it with a .java file extension, just as when you write a Java application.
- Compile the applet into bytecode using the javac command, just as when you write a Java application.
- Write an HTML document that includes a statement to call your compiled Java class.
- Load the HTML document into a Web browser (such as Internet Explorer) or run the Applet Viewer program, which in turn uses the HTML document.

Java in general and applets in particular are popular topics among programmers, partly because users can execute applets using a Web browser on the Internet. A **Web browser** is a program that allows you to display HTML documents on your computer screen. Web documents often contain Java applets.



Because applets are sent over the Internet and run from other applications, applet code is not trusted. A malicious programmer might try to include code that contains a virus, reads data from your files, or performs other unwanted tasks. Therefore, applet code runs in a constrained area called a sandbox. A **sandbox** is a safe area in which a program can run, much like a real sandbox is an area in a yard where children can play safely.

Fortunately, to run a Java applet, you don't need to learn much HTML; you need to learn only two pairs of HTML commands, called **tags**. The tag that begins every HTML document is `<html>`. Like all tags, this opening tag is surrounded by angle brackets. The `html` within the tag is an HTML keyword that specifies that an HTML document follows the keyword. The tag that ends every HTML document is `</html>`. The preceding slash indicates that the tag is a closing tag. The following is the simplest HTML document you can write:

```
<html>
</html>
```



Unlike Java, HTML is not case sensitive, so you can use `<HTML>` in place of `<html>`. However, this book uses the all-lowercase convention when displaying HTML code. With the growing importance of XML and XHTML, many programmers recommend putting all HTML tags in lowercase because XML and XHTML are case sensitive, even though HTML is not.

The simple HTML document, containing just the pair of `html` tags, begins and ends and does nothing in between; you can create an analogous situation in a Java method by typing an opening curly brace and following it immediately with the closing curly brace. HTML documents generally contain more statements. For example, to run an applet from an HTML document, you add an `<object>` and `</object>` tag pair. Usually, you place three attributes within the `<object>` tag: `code`, `width`, and `height`. **Tag attributes**, sometimes referred to as arguments, promote activity or describe the features of the tag; with arguments, the HTML tag can do something in a certain way. Note the following example:

```
<object code = "Aclass.class" width = 300 height = 200> </object>
```

The three `object` tag attributes in the previous example are described with their corresponding arguments in the following list:

- `code =` is followed by the name of the compiled applet you are calling.
- `width =` is followed by the width of the applet on the screen.
- `height =` is followed by the height of the applet on the screen.

The name of the applet you call must be a compiled Java applet (with a `.class` file extension). The width and height of an applet are measured in pixels. For monitors that display 1024 pixels horizontally and 768 pixels vertically, a statement such as `width = 512 height = 384` creates an applet that occupies approximately one-fourth of most screens (half the height and half the width).



When you assign a height and width to an applet, keep in mind that a browser's menu bar and screen elements (such as the toolbar and the scroll bars) take up some of the screen viewing area for an applet.



Instead of the `<object>` and `</object>` tag pair, you can use `<applet>` and `</applet>` in your HTML applet host documents. However, the World Wide Web Consortium recommends using `object` rather than `applet` because it is more general, and includes new and future media types in addition to applets. For more information, including definitions of and recommendations for using all the other HTML tags, visit [www.w3.org](http://www.w3.org).

Figure 17-2 shows an HTML file that could be used to run a JApplet named JHello. The applet will be 450 pixels wide by 150 pixels tall.

830

```
<html>
<object code = "JHello.class" width = 450 height = 150>
</object>
</html>
```

**Figure 17-2** The TestJHello.html file



In Figure 17-2, the JHello.class file resides in the same folder as the HTML file, so no path is necessary in the object code statement. Later in this chapter, you will learn how to create the JHello class.

## TWO TRUTHS & A LIE

### Writing an HTML Document to Host an Applet

1. You must run applets within a Web page.
2. To view an applet, it must be called from another document, such as one written in HTML.
3. All HTML tags are surrounded by angle brackets.

The false statement is #1. You run applets within a page on the Internet or an intranet; you also can run an applet on a local computer from another program called Applet Viewer.

## Creating a JApplet that Contains an `init()` Method

The `JApplet` class uses several methods that are invoked by a Web browser when the browser runs an applet. In a Java application, the `main()` method calls other methods that you write, but in contrast, an applet does not contain a `main()` method. With an applet, the browser or Applet Viewer calls several methods automatically at different times. The following five methods are inherited from `JApplet`, are called automatically, and constitute the life cycle of an applet:

- `public void init()`
- `public void start()`
- `public void paint()`



- `public void stop()`
- `public void destroy()`

You can override any of these methods within a `JApplet` that you write. If you fail to implement one or more of these methods, your `JApplet` will use the versions that belong to the parent `JApplet` class. To create a Java applet that does anything useful, you must code statements within at least one of these methods.

For example, you can create a `JApplet` using only the `init()` method. The **`init()` method** is the first method called in any applet. You use it to perform initialization tasks, such as setting variables to initial values or placing applet components on the screen. In general, tasks that you would place in the constructor for a `JFrame` in an application are the same types of tasks you place in an `init()` method in a `JApplet`.

You must code the `init()` method's header as follows:

```
public void init()
```

Figure 17-3 shows the `JApplet` that displays "Hello. Who are you?" on the screen.

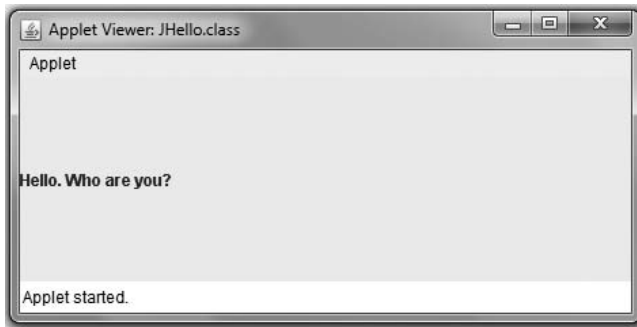
```
import javax.swing.*;
import java.awt.*;
public class JHello extends JApplet
{
    JLabel greeting = new JLabel("Hello. Who are you?");
    public void init()
    {
        add(greeting);
    }
}
```

**Figure 17-3** The `JHello` `JApplet`

After you write this `JApplet`, you do the following:

- Save this file as `JHello.java`, and compile it.
- Run the Applet Viewer using the command `appletviewer TestJHello.html` and the saved file shown in Figure 17-2.

Figure 17-4 shows how the applet appears on your screen. After you view a `JApplet`, you can click the close button on the Applet Viewer to end the application. Unlike a `JFrame`, you do not need to set a default close operation with a `JApplet`.



**Figure 17-4** Output of the `JHello` `JApplet` when run in the Applet Viewer



Watch the video *Writing and Running an Applet*.

## TWO TRUTHS & A LIE

### Creating a `JApplet` that Contains an `init()` Method

1. In a Java applet, the `main()` method is the first to execute; it calls other methods that you write.
2. The following five methods can automatically be called by every applet: `init()`, `start()`, `paint()`, `stop()`, and `destroy()`.
3. You can create a `JApplet` using only the `init()` method, which is the first method called in any applet.

The false statement is #1. In a Java application, the `main()` method calls other methods that you write, but in contrast, an applet does not contain a `main()` method.

## Working with `JApplet` Components

The output in Figure 17-4 is not very attractive or interesting. Fortunately, all the techniques that you used with `JFrames` in Chapters 14, 15, and 16 can also be used with `JApplets`. For example, you can do the following:

- Change the font and color of labels.
- Use layout managers.
- Add multiple GUI components.
- Change the background color.

- Add listeners for user events.
- Add images and sounds.

For example, Figure 17-5 shows how you can write a JApplet that displays a prompt, allows the user to enter text and press a button, and displays output. The JApplet also uses color and interesting fonts. The `init()` method sets up the applet surface and enables both the button and text box to generate events to which the JApplet can respond.

```
import javax.swing.*;
import java.awt.*;
import java.awt.event.*;
import java.awt.Color;
public class JHello2 extends JApplet implements ActionListener
{
    JLabel greeting = new JLabel("Hello. Who are you?");
    Font font1 = new Font("Teen", Font.BOLD, 36);
    Font font2 = new Font("Teen", Font.ITALIC, 48);
    JTextField answer = new JTextField(10);
    JButton pressMe = new JButton("Press me");
    JLabel personalGreeting = new JLabel(" ");
    Container con = getContentPane();
    public void init()
    {
        greeting.setFont(font1);
        personalGreeting.setFont(font2);
        con.add(greeting);
        con.add(answer);
        con.add(pressMe);
        con.setLayout(new FlowLayout());
        con.setBackground(Color.YELLOW);
        pressMe.addActionListener(this);
        answer.addActionListener(this);
    }
    public void actionPerformed(ActionEvent e)
    {
        String name = answer.getText();
        con.remove(greeting);
        con.remove(pressMe);
        con.remove(answer);
        personalGreeting.setText("Hello, " + name + "! ");
        con.add(personalGreeting);
        con.setBackground(Color.PINK);
        validate();
    }
}
```

**Figure 17-5** The `JHello2` class that adds a `JLabel` when the user clicks the `JButton`

The code in the `actionPerformed()` method in the `JHello2` class shows that after the user clicks the button, the name is retrieved from the text field; the label, button, and text field are removed from the applet surface; and the `setText()` method sets the `JLabel` text for

personalGreeting to "Hello, " + name + "! ". Then the personal greeting is added to the JApplet's Container, and the background color is changed. You learned about all of the same methods when you studied JFrames in Chapters 14 and 15. Figure 17-6 shows a typical execution.



**Figure 17-6** Typical execution of the JHello2 JApplet

In the `actionPerformed()` method in Figure 17-5, the final statement following the addition of the `JLabel` is `validate()`. As you learned in Chapter 15, invoking the `validate()` method after adding one or more `JComponents` to an applet ensures that the `Components` draw themselves on the screen. It isn't necessary to call the `validate()` method every time you add a `JComponent` to a `JApplet`. For example, when you add components in the `init()` or `start()` methods, you do not have to call `validate()`. When you add components in other methods (frequently event-handling methods), you must call `validate()`.



The `validate()` method is complex. Even the online Java documentation refers to its performance as "voodoo."



Watch the video *Working with JApplet Components*.

## TWO TRUTHS & A LIE

835

### Working with JApplet Components

1. In an applet, you can change fonts and colors of GUI components just as you can in an application.
2. JApplets can contain an `actionPerformed()` method to respond to mouse clicks.
3. Invoking the `validate()` method in an applet allows it to pass security restrictions.

The false statement is #3. Invoking the `validate()` method after adding one or more JComponents to an applet ensures that the components draw themselves on the screen.

## Understanding the JApplet Life Cycle

Applets are popular because they are easy to use in Web pages. Because applets execute in a browser, the `JApplet` class contains methods that are automatically called by the browser. You already are familiar with the `paint()` method. In Chapter 16 you learned that the system can request that a component's contents be repainted, or that the application can request repainting. The `paint()` method is always called after the `init()` and `start()` methods execute. It is also called if an applet needs repainting—if, for example, the user covers part of an applet with another open window and then uncovers it. The method works the same way with JApplets as with JFrames. The method header is as follows:

```
public void paint(Graphics g)
```

As you learned in Chapter 16, the `paint()` method provides you with a `Graphics` object. If you override the `paint()` method in your applet, you can use the automatically provided `Graphics` object to draw shapes and strings.

The other four methods that are automatically called in a `JApplet` are `init()`, `start()`, `stop()`, and `destroy()`.

## The `init()` Method

You have already seen examples of `JApplet`s that contain `init()` methods. When a Web page containing a `JApplet` is loaded in the browser, or when you run the `appletviewer` command within an HTML document that calls a `JApplet`, the applet's `init()` method executes. The `init()` method might be your version (if you have written one to override the version in the parent class) or the automatically provided version. You should write your own `init()` method when you have any initialization tasks to perform, such as setting up user interface components.

## The `start()` Method

The **`start()` method** executes after the `init()` method, and it executes again every time the applet becomes active after it has been inactive. For example, if you run a `JApplet` using the `appletviewer` command and then minimize the Applet Viewer window, the `JApplet` becomes inactive. When you restore the window, the `JApplet` becomes active again. On the Internet, users can leave a Web page, visit another page, and then return to the first site. Again, the `JApplet` becomes inactive and then active. When you write your own `start()` method, you must include any actions you want your `JApplet` to take when a user revisits the `JApplet`. For example, you might want to resume some animation that you suspended when the user left the applet.

## The `stop()` Method

When a user leaves a Web page (perhaps by minimizing a window or traveling to a different Web page), the **`stop()` method** is invoked. You override the existing empty `stop()` method only if you want to take some action when a `JApplet` is no longer visible. You usually don't need to write your own `stop()` methods.

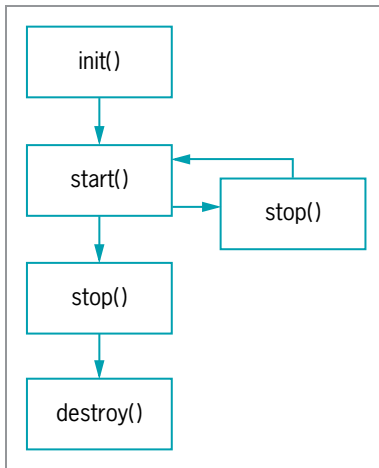
## The `destroy()` Method

The **`destroy()` method** is called when the user closes the browser or Applet Viewer. Closing the browser or Applet Viewer releases any resources the `JApplet` might have allocated. As with the `stop()` method, you do not usually have to write your own `destroy()` methods.



Advanced Java programmers override the `stop()` and `destroy()` methods when they want to add instructions to “suspend a thread,” or stop a chain of events that were started by a `JApplet` but are not yet completed.

Every `JApplet` has the same life cycle outline, as shown in Figure 17-7. When the applet executes, the `init()` method runs, followed by the `start()` method. If the user leaves the `JApplet`'s page, the `stop()` method executes. When the user returns, the `start()` method executes. The `stop()` and `start()` sequence might continue any number of times until the user closes the browser (or Applet Viewer), which invokes the `destroy()` method.



**Figure 17-7** The JApplet life cycle

## TWO TRUTHS & A LIE

### Understanding the JApplet Life Cycle

1. The `paint()` method is always called after the `init()` and `start()` methods execute or if an applet needs repainting.
2. When a Web page containing a JApplet is loaded in the browser, the applet's `start()` method is the first to execute.
3. When a user leaves a Web page, the `stop()` method executes.

The false statement is #2. When a Web page containing a JApplet is loaded in the browser, or when you run the appletviewer command within an HTML document that calls a JApplet, the applet's `init()` method is the first to execute.

## Understanding Multimedia and Using Images

**Multimedia** describes the use of sound, images, graphics, and video in computer programs. Most computers that are sold today are “multimedia ready”—that is, they have CD-RW and DVD-RW drives, audio boards, and video capabilities. Java provides extensive multimedia tools, including the following:

- Java programmers can use the Java 2D or the Java 3D Application Programming Interface (API) to create 3D graphics applications.
- The Java Media Framework (JMF) API allows you to add audio and video media to an application.

- Java Sound allows you to play, record, and modify audio files.
- The Java Advanced Imaging API provides image-manipulation capabilities.
- The Java Speech API allows a user to input speech commands and allows an application to produce speech output.

## Adding Images to JApplets

An **image** is a likeness of a person or thing. Images abound on the Internet in all shapes, colors, and sizes. Image formats supported by Java include:

- Graphics Interchange Format (GIF), which can contain a maximum of 256 different colors
- Joint Photographic Experts Group (JPEG), which is commonly used to store photographs, and is a more sophisticated way to represent a color image
- Portable Network Graphics (PNG), which is more flexible than GIF and stores images in a lossless form. (PNG was originally designed to be a portable image storage form for computer-originated images.) **Lossless data compression** is a set of rules that allows an exact replica of data to be reconstructed from a compressed version. If you have ever worked with a .zip file, you have worked with lossless data compression.

The `Image` class provides many of Java's image capabilities; this class loads images that have been stored in one of the allowed `Image` formats. The `Image` class, which you can find in the `java.awt` package, is an abstract class. Recall that an abstract class is one from which you cannot create any objects, but which you can use as an interface or from which you can inherit. Because `Image` is abstract, you must create `Image` objects indirectly using the `getImage()` method.

The `getImage()` method is used to load an `Image` into the named `Image` in the applet. One version of the `getImage()` method can take up to two arguments: a location where the image is stored and its filename. For example, you can create and load an `Image` named `companyLogo` with a statement such as the following:

```
companyLogo = getImage(getCodeBase(), "logo.gif");
```

The `getCodeBase()` call returns the Uniform Resource Locator (URL) where the code is located. That is, it finds the directory from which the code is running.

You can use the applet `paint()` method to display `Image` object images. The `drawImage()` method is a `Graphics` method that uses the following four arguments:

- The first argument is a reference to the `Image` object in which the image is stored.
- The second argument is the x-coordinate where the image appears on the applet.
- The third argument is the y-coordinate where the image appears on the applet.
- The fourth argument is a reference to an `ImageObserver` object.

An `ImageObserver` object can be any object that implements the `ImageObserver` interface. Because the `Component` class implements the `ImageObserver` interface, all `Components`,



including `JApplets`, inherit this implementation. Usually, the `ImageObserver` object is the object on which the image appears—in this case, the `JApplet`. Recall from Chapter 4 that the `this` reference refers to the current object using a method. Frequently, with the `drawImage()` method, you use the `this` reference to indicate that you want the `Image` drawn on the current `JApplet`. For example, the code to display the `companyLogo` image in the upper-left corner of the `JApplet` is as follows:

```
g.drawImage(companyLogo, 0, 0, this);
```

You can use an overloaded version of the `Graphics` method `drawImage()` to output a scaled image. This method takes six arguments. Notice that the first three arguments are the same as those for the four-argument version of the `drawImage()` method. In the overloaded version:

- The first argument is a reference to the `Image` object in which the image is stored.
- The second and third arguments are the *x*- and *y*-coordinates where the image appears on the applet.
- The fourth and fifth arguments are the width and height of the scaled object.
- The sixth argument uses the `this` reference to implement the `ImageObserver` object.

For example, the following code displays the `companyLogo` image at coordinates 0, 120 using the full width of the `JApplet`, but 100 pixels less than the height:

```
g.drawImage(companyLogo, 0, 120, getWidth(), getHeight() - 100, this);
```

Figure 17-8 shows a `JApplet` that draws an image twice. The `JCompanyImage` `JApplet` uses an image file named `CompanyLogo.png`, which holds a logo that is originally 287 pixels wide by 129 pixels high. Within the `paint()` method in the `JApplet`, the image is drawn first in its “natural,” or original, size in the upper-left corner. Then it is redrawn lower at twice its original size. Figure 17-9 shows the contents of the HTML document that displays the applet; the output of the `JCompanyImage` applet is shown in Figure 17-10.

```
import java.awt.*;
import java.applet.*;
import javax.swing.*;
public class JCompanyImage extends JApplet
{
    Image companyLogo;
    final int WIDTH = 287;
    final int HEIGHT = 129;
    final int FACTOR = 2;
    public void init()
    {
        companyLogo = getImage(getCodeBase(), "CompanyLogo.png");
    }
}
```

**Figure 17-8** The `JCompanyImage` `JApplet` (continues)

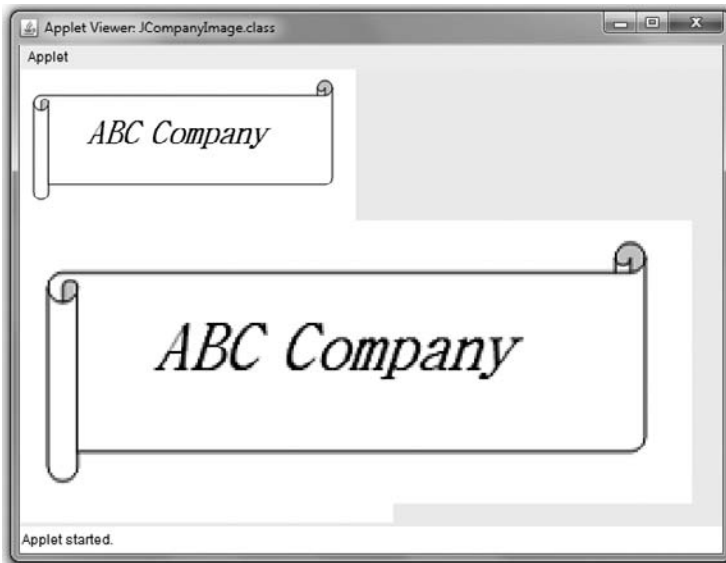
(continued)

```
public void paint(Graphics g)
{
    super.paint(g);
    // Draw image at its natural size
    g.drawImage(companyLogo, 0, 0, this);
    // Draw the image scaled - twice as large
    g.drawImage(companyLogo, 0, HEIGHT, WIDTH * FACTOR,
                HEIGHT * FACTOR, this);
}
}
```

**Figure 17-8** The JCompanyImage JApplet

```
<html>
<object code = "JCompanyImage.class" width = 600 height = 390>
</object>
</html>
```

**Figure 17-9** The TestJCompanyImage HTML document



**Figure 17-10** Output of the JCompanyImage JApplet



You can examine the CompanyLogo.png file in the Chapter.17 folder of your downloadable student files.

## Using ImageIcon

You can also use the `ImageIcon` class to create images in your applications and applets. In general, working with the `ImageIcon` class is simpler than working with `Image`. You can use all the `Image` methods with an `ImageIcon`, plus many additional methods. Unlike the `Image` class, you can create `ImageIcon` objects directly. Also, unlike `Images`, you can place an `ImageIcon` on a `Component`, such as a `JPanel`, `JLabel`, or `JButton`, as well as on a `JApplet` or `JFrame`. For example, the following statements create a `JButton` that contains a picture of an arrow:

```
ImageIcon arrowPicture = new ImageIcon("arrow.gif");
JButton arrowButton = new JButton(arrowPicture);
```



Behind the scenes, each `ImageIcon` object uses an `Image` object to hold the image data and a `MediaTracker` object to keep track of the image's loading status. As you are aware if you have visited many Web pages, some images can require a good deal of time to load. To improve performance, the `Image` `get()` methods return immediately while the image continues to load, so that your application does not have to wait before performing other operations.

You can also use the `paintIcon()` method to display `ImageIcon` images. This method requires four arguments:

- The first argument is a reference to the `Component` on which the image appears—this in the following example.
- The second argument is a reference to the `Graphics` object used to render the image—`g` in the following example.
- The third and fourth arguments are the *x*- and *y*-coordinates for the upper-left corner of the image.

The code to display the `arrowPicture` `ImageIcon` using the `paintIcon()` method is:

```
arrowPicture.paintIcon(this, g, 180, 0);
```

You can retrieve an `ImageIcon`'s width and height with methods named `getIconWidth()` and `getIconHeight()`; each returns an integer. Figure 17-11 shows an example of how you can manipulate an `ImageIcon`'s width and height to achieve display effects. In the `JBear` `JApplet`, an `ImageIcon` is created using a `.gif` file. In the `init()` method, the width and height of the `ImageIcon` are stored in variables named `width` and `height`. In the `actionPerformed()` method, the width and height of the image are doubled with every button click. Figure 17-12 shows the `JApplet` when it starts, after the user has clicked the button once, and after the user has clicked the button twice.

```
import java.awt.*;
import java.awt.event.*;
import javax.swing.*;
public class JBear extends JApplet implements ActionListener
{
    private ImageIcon image = new ImageIcon("bear.gif");
    private JButton closerButton = new JButton("Oh my!");
    private int width, height;
    Container con = getContentPane();
    public void init()
    {
        con.setLayout(new FlowLayout());
        closerButton.addActionListener(this);
        con.add(closerButton);
        width = image.getIconWidth();
        height = image.getIconHeight();
    }
    public void actionPerformed(ActionEvent event)
    {
        width = width * 2;
        height = height * 2;
        repaint();
    }
    public void paint(Graphics g)
    {
        super.paint(g);
        g.drawImage(image.getImage(), 0, 0, width, height, this);
    }
}
```

**Figure 17-11** The JBear JApplet



In the JBear JApplet in Figure 17-11, if you eliminate the call to `super.paint()` as the first statement in the `paint()` method, then as you get each new bear image, the previous one remains on the screen “behind” the newer, larger one.



**Figure 17-12** Output of the JBear JApplet

In the `paint()` method in the `JBear JApplet`, notice that the `drawImage()` method uses the `getImage()` method with the image in the following statement:

```
g.drawImage(image.getImage(), 0, 0, width, height, this);
```

An `ImageIcon` cannot be drawn to scale, but an `Image` can, so you use the `getImage()` method to return a scalable `Image` reference.

## TWO TRUTHS & A LIE

### Understanding Multimedia and Using Images

1. Multimedia describes the use of sound, images, graphics, and video in computer programs; most computers that are sold today are “multimedia ready.”
2. Image formats supported by Java include GIF, JPEG, and PNG.
3. You can use the `Picture` class to create images in your applications and applets.

The false statement is #3. You can use the `Image` or `ImageIcon` class to create images in your applications and applets; you can even place an `ImageIcon` on a component, such as a `JPanel` or `JButton`.

## Adding Sound to JApplets

Java programs can play audio clips on computers that have speakers and a sound card (which includes most computers that are sold today). Java supports sound using methods from the `Applet` class, rather than `JApplet`. You can use these methods to retrieve and play sound files that use various sound formats. These formats include the Windows Wave file format (.wav), Sun Microsystems Audio file format (.au), and Music and Instrument Digital Interface file format (.midi or .mid).

The simplest way to retrieve and play a sound is to use the `play()` method of the `Applet` class. The `play()` method retrieves and plays the sound as soon as possible after it is called. The `play()` method takes one of two forms:

- `play()` with one argument—The argument is a URL object that loads and plays an audio clip when both the URL object and the audio clip are stored at the same URL.
- `play()` with two arguments—The first argument is a URL object, and the second argument is a folder path name that loads and plays the audio file. The first argument is often a call to a `getCodeBase()` method or `getDocumentBase()` method to retrieve the URL object; the second argument is the name of the audio clip within the folder path that is stored at that URL.

Used with the `codebase` attribute, which indicates the filename of the applet’s main class file, the `getCodeBase()` and `getDocumentBase()` methods direct the browser to look in a different folder for the applet and other files it uses. This is necessary when the desired files are in a different location than the Web page containing the applet. By calling `getCodeBase()` in an applet, you get a URL object that represents the folder in which the applet’s class file is stored. For example, the following statement retrieves and plays the `tune.au` sound file, which is stored in the same place as the applet:

```
play(getCodeBase(),"tune.au");
```



The `getDocumentBase()` method returns an absolute URL naming the directory of the document in which the applet is stored. It is sometimes used instead of `getCodeBase()` as a matter of preference. An applet is restricted to reading files only from the server that hosts it.

To play a sound more than once, or to start or stop the sound, you must load the sound into an `AudioClip` object using the applet's `newAudioClip()` method. `AudioClip` is part of the `java.awt.Applet` class and must be imported into your program. Like the `play()` method, the `getAudioClip()` method can take one or two arguments. The first argument (or only argument, if there is only one) is a URL argument that identifies the sound file; the second argument is a folder path reference needed for locating the file.

The following statement loads the sound file from the previous example into the clip object:

```
AudioClip aClip = new AudioClip(getCodeBase(), "audio/tune.au");
```

Here, the sound file reference indicates that the `tune.au` sound file is in the `audio` folder. After you have created an `AudioClip` object, you can use the `play()` method to call and play the sound, the `stop()` method to halt the playback, and the `loop()` method to play the sound repeatedly. Multiple `AudioClip` items can play at the same time, and the resulting sound is mixed together to produce a composite.



In the You Do It section, you will create a `JApplet` that plays a sound.



Watch the video *Using Images and Sound in an Applet*.

## TWO TRUTHS & A LIE

### Adding Sound to JApplets

1. Java programs can play audio clips on computers that have speakers and a sound card.
2. Java supports sound using methods from the `JApplet` class.
3. Sound formats that applets can use include the Windows Wave file format (.wav), Sun Audio file format (.au), and Music and Instrument Digital Interface file format (.midi or .mid).

The false statement is #2. Java supports sound using methods from the `Applet` class (rather than `JApplet`).

## You Do It

### Creating an HTML Document to Host an Applet

In this section, you create a simple HTML document that you will use to display the applet you will create in the next section. You will name the applet `JGreet`, and it will occupy a screen area of 450 by 200 pixels.

846

#### To create an HTML document to host an applet:

1. Open a new file in your text editor. Type the opening HTML tag:  
`<html>`
2. On the next line, type the opening `object` tag that contains the applet's name and dimensions:  
`<object code = "JGreet.class" width = 450 height = 100>`
3. On the next line, type the applet's closing tag:  
`</object>`
4. On the next line, type the closing HTML tag:  
`</html>`
5. Save the file as **TestJGreet.html**. Just as when you create a Java application, be certain that you save the file as text only and use an `.html` extension. The `.html` file extension is required and makes the file easy to identify as an HTML file.

### Creating and Running a JApplet

Next, you will create the `JGreet` applet for which you prepared the HTML document.

#### To create and run the `JGreet` applet:

1. Open a new text file in your text editor. Enter the following `import` statements you need for the `JApplet`. You need the `javax.swing` package because it defines `JApplet`, and you need the `java.awt` package because it defines `Container`.

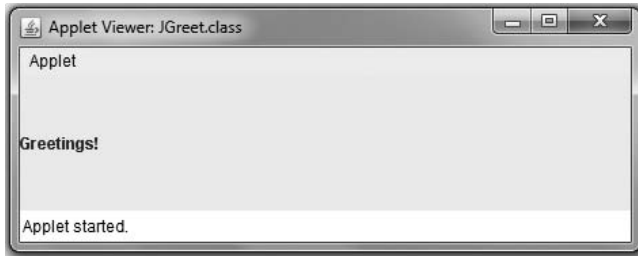
```
import javax.swing.*;  
import java.awt.*;
```

2. Next, enter the `JGreet` `JApplet`. It contains a `Container` that holds a `JLabel`. The `init()` method adds the `JLabel` to the `Container`.

```
public class JGreet extends JApplet  
{  
    Container con = getContentPane();  
    JLabel greeting = new JLabel("Greetings!");  
    public void init()  
    {  
        con.add(greeting);  
    }  
}
```



3. Save the file as **JGreet.java**. Then compile the class. If necessary, correct any errors and compile again.
4. At the command line, type **appletviewer TestJGreet.html** and then press **Enter**. The applet appears on your screen, as shown in Figure 17-13.



**Figure 17-13** The JGreet JApplet

5. Use the mouse pointer to drag any corner of the Applet Viewer window to resize it. Notice that if you increase or decrease the window's height, the window is redrawn on the screen and the `JLabel` is automatically repositioned to remain centered within the window. If you make the window narrower by dragging its right border to the left, the `JLabel` eventually becomes partially obscured when the window becomes too narrow for the display.



If your operating system does not allow you to make the window narrow enough to obscure part of the greeting, make the string in the label longer—for example, "Greetings to you and all your family!" Recompile the applet and then use the `appletviewer` command to display the HTML document again. The string displayed will be long enough for you to observe the effects when you narrow the width of the window.

6. Close the Applet Viewer by clicking the **Close button** in the upper-right corner of the window.

## Running a JApplet in Your Web Browser

### To run the applet using your Web browser:

1. Open any Web browser, such as Internet Explorer. You do not have to connect to the Internet; you will use the browser locally. (If you do not have a Web browser installed on your computer, skip to the end of Step 3.)
2. Click **File** on the menu bar, click **Open**, type the complete path for the HTML document that you created to access `JGreet.class` (for example, `C:\Java\Chapter.17\TestJGreet.html`), and then press **Enter**. Instead of typing the filename, you can click the **Browse** button, browse to the file location, and then click **OK**. You might have to agree to several security messages before you can view the applet. The applet should appear in the browser on your screen. If you receive an error message, verify that the path and spelling of the HTML file are correct.

3. Click the **Close button** in the upper-right corner of the browser to close your Web browser.



848

Some applets might not work correctly with your browser. Java was designed with a number of security features so that when an applet is displayed on the Internet, the applet cannot perform malicious tasks, such as deleting a file from your hard drive. If an applet does nothing to compromise security, testing it using the Web browser or the `appletviewer` command achieves the same results. For now, you can get your applets to perform better by using the Applet Viewer window because the output does not depend on the browser type or version.

## Creating a More Complicated JApplet

Next, you will change the font of the text in your `JGreet` applet, add components, and make other changes to make a more complicated and useful `JApplet`.

### To change the `JGreet` applet:

1. Open the `JGreet.java` file in your text editor, and change the class name to `JGreet2`. Immediately save the file using the filename `JGreet2.java`.

2. After the declaration of the `greeting JLabel`, declare a `Font` object named `bigFont` by typing the following:

```
Font bigFont = new Font("Times Roman", Font.ITALIC, 24);
```

3. Within the `init()` method, set the `greeting font` to `bigFont` by typing the following:

```
greeting.setFont(bigFont);
```

4. Along with the other declarations, declare two `JLabels`, two empty `JTextFields`, and a `JButton` with the label "View Greeting" by typing the following:

```
JLabel firstLabel = new JLabel("Please enter your first name:");  
JLabel lastLabel = new JLabel("Please enter your last name:");  
JTextField firstField = new JTextField("", 10);  
JTextField lastField = new JTextField("", 10);  
JButton viewButton = new JButton("View Greeting");
```

5. Set the new layout manager to a flow layout with the following statement:

```
FlowLayout flow = new FlowLayout();
```

6. Within the `init()` method, set a layout manager as follows:

```
con.setLayout(flow);
```

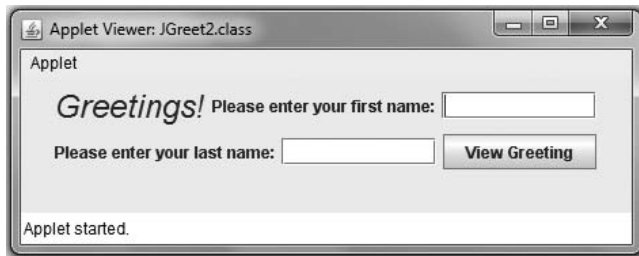
7. Add all the newly created components to the applet by typing the following:

```
con.add(firstLabel);  
con.add(firstField);  
con.add(lastLabel);  
con.add(lastField);  
con.add(viewButton);
```

8. On the next line, request focus for the first-name text field by typing:

```
firstField.requestFocus();
```

9. Save the file and compile it.
10. Open the **TestJGreet.html** document you created earlier and change the class name in the object code statement to **JGreet2.class**. Save the file as **TestJGreet2.html**. Execute the **appletviewer TestJGreet2.html** command. The output is shown in Figure 17-14. Confirm that you can type characters into the `JTextField`s and that you can click the `JButton` using the mouse. You haven't coded any action to take place as a result of a `JButton` click yet, but the components should function.



**Figure 17-14** The `JGreet2` `JApplet`

11. Close the Applet Viewer window.

## Making the `JApplet`'s Button Respond to Events

Next, you will make your applet an event-driven program by adding functionality to the applet. When the user enters a name and clicks the `JButton`, the `JApplet` displays a personalized greeting.

### To add functionality to your `JApplet`:

1. Open the **JGreet2.java** file in your text editor, and change the class name to **JGreet3**. Immediately save the file as **JGreet3.java**.
2. Add a third `import` statement to your program by typing the following:
 

```
import java.awt.event.*;
```
3. Add the following phrase to the class header:
 

```
implements ActionListener
```
4. Prepare your `JApplet` for `JButton`-sourced events by typing the following statement within the `init()` method:
 

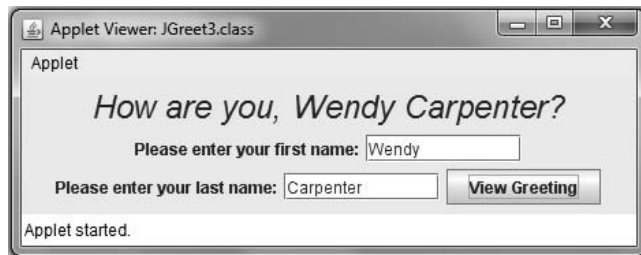
```
viewButton.addActionListener(this);
```
5. Following the `init()` method, add the following `actionPerformed()` method. In the method, declare two `Strings`—one to hold the user's first name and another for the last name—and then use the `getText()` method on the `JTextFields` to

retrieve values for these Strings. Using the Strings, display a personalized question for the user.

```
public void actionPerformed(ActionEvent thisEvent)
{
    String firstName = firstField.getText();
    String lastName = lastField.getText();
    greeting.setText("How are you, " + firstName + " " +
        lastName + "?");
}
```

850

6. Save the file and compile the program. Edit the file **TestJGreet2.html** to change the class reference to **JGreet3.class**, and then save the file as **TestJGreet3.html**. Run the applet using the **appletviewer TestJGreet3.html** command.
7. Type your name in the `JTextField`s, and then click the **View Greeting** button. The personalized message should appear, similar to the one in Figure 17-15.



**Figure 17-15** Typical execution of the `JGreet3` `JApplet`

8. Drag the mouse to highlight the first or last name (or both) in the Applet Viewer window, and then type a different name. Click the **View Greeting** button. A greeting that uses the new name appears.
9. Close the Applet Viewer window.

## Understanding the Applet Life Cycle

To demonstrate the life cycle methods in action, you can write a `JApplet` that overrides all four methods: `init()`, `start()`, `stop()`, and `destroy()`. When you run this applet, you can observe the number of times each method executes.

### To demonstrate the life cycle of a `JApplet`:

1. Open a new text file in your text editor, and then type the following `import` statements:

```
import javax.swing.*;
import java.awt.*;
import java.awt.event.*;
```

- To make the `JApplet` include a `JButton` that the user can click, and to implement an `ActionListener`, type the following header for a `JLifeCycle` applet and include an opening curly brace for the class:

```
public class JLifeCycle extends JApplet implements ActionListener
{
```

- Declare the following six `JLabel` objects, which display each of the six methods that execute during the lifetime of the applet:

```
JLabel messageInit = new JLabel("init ");
JLabel messageStart = new JLabel("start ");
JLabel messageDisplay = new JLabel("display ");
JLabel messageAction = new JLabel("action ");
JLabel messageStop = new JLabel("stop ");
JLabel messageDestroy = new JLabel("destroy ");
```

- Declare a `JButton` by typing the following:

```
JButton pressButton = new JButton("Press");
```

- Declare six integers that hold the number of occurrences of each of the six methods by typing the following code:

```
int countInit, countStart, countDisplay, countAction,
countStop, countDestroy;
```

- Start the `init()` method by adding a container and flow layout manager with the following statements:

```
public void init()
{
Container con = getContentPane();
con.setLayout(new FlowLayout());
```

- Add the following statements, which add 1 to `countInit`, place the components within the applet, and then call the `display()` method:

```
++countInit;
con.add(messageInit);
con.add(messageStart);
con.add(messageDisplay);
con.add(messageAction);
con.add(messageStop);
con.add(messageDestroy);
con.add(pressButton);
pressButton.addActionListener(this);
display();
}
```

- Add the following `start()` method, which adds 1 to `countStart` and calls `display()`:

```
public void start()
{
++countStart;
display();
}
```

9. Add the following `display()` method, which adds 1 to `countDisplay`, displays the name of each of the six methods with the current count, and indicates how many times the method has executed:

```
public void display()
{
    ++countDisplay;
    messageInit.setText("init " + countInit);
    messageStart.setText("start " + countStart);
    messageDisplay.setText("display " + countDisplay);
    messageAction.setText("action " + countAction);
    messageStop.setText("stop " + countStop);
    messageDestroy.setText("destroy " + countDestroy);
}
```

10. Add the following `stop()` and `destroy()` methods. Each adds 1 to the appropriate counter and calls `display()`:

```
public void stop()
{
    ++countStop;
    display();
}
public void destroy()
{
    ++countDestroy;
    display();
}
```

11. When the user clicks `pressButton`, the following `actionPerformed()` method executes; it adds 1 to `countAction` and displays it:

```
public void actionPerformed(ActionEvent e)
{
    ++countAction;
    display();
}
```

12. Add the closing curly brace for the class. Save the file as **JLifeCycle.java**. Compile the class.

Take a moment to examine the code you created for `JLifeCycle.java`. Each method adds 1 to one of the six counters, but you never explicitly call any of the methods except `display()`; each of the other methods is called automatically. Next, you will create an HTML document so you can test `JLifeCycle.java`.

### To create an HTML document to test `JLifeCycle.java`:

1. Open a new text file in your text editor, and then enter the following HTML code:

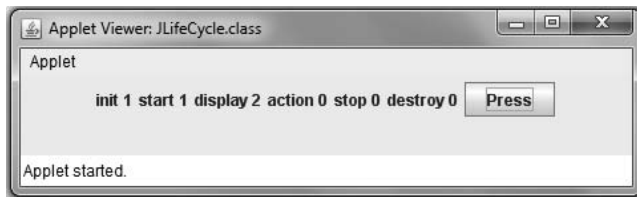
```
<html>
<object code = "JLifeCycle.class" width = 460 height = 60>
</object>
</html>
```

2. Save the file as **TestJLifeCycle.html**.

3. Run the HTML document using the following command:

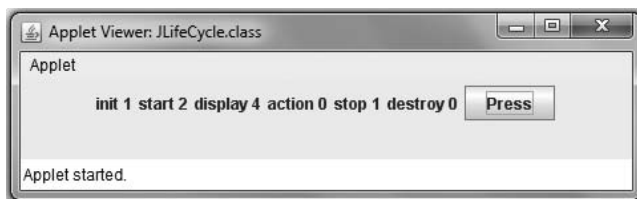
**appletviewer TestJLifeCycle.html**

Figure 17-16 shows the output. When the applet begins, the `init()` method is called, so 1 is added to `countInit`. The `init()` method calls `display()`, so 1 is added to `countDisplay`. Immediately after the `init()` method executes, the `start()` method is executed, and 1 is added to `countStart`. The `start()` method calls `display()`, so 1 more is added to `countDisplay`. The first time you see the applet, `countInit` is 1, `countStart` is 1, and `countDisplay` is 2. The methods `actionPerformed()`, `stop()`, and `destroy()` have not yet been executed.



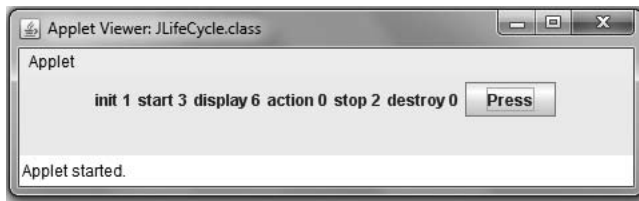
**Figure 17-16** The `JLifeCycle` `JApplet` when it first executes

4. Click the **Minimize** button to minimize the Applet Viewer window, and then click the **Taskbar** button to restore it. The applet now looks like Figure 17-17. The `init()` method still has been called only once, but when you minimized the applet, the `stop()` method executed, and when you restored it, the `start()` method executed. Therefore, `countStop` is now 1 and `countStart` has increased to 2. In addition, because `start()` and `stop()` call `display()`, `countDisplay` is increased by 2 and now holds the value 4.



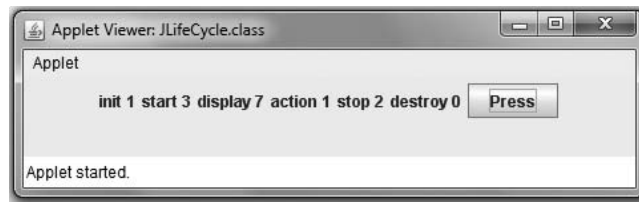
**Figure 17-17** The `JLifeCycle` `JApplet` after minimizing and restoring

5. Minimize and restore the Applet Viewer window again. Now, the `stop()` method has executed twice, the `start()` method has executed three times, and the `display()` method has executed a total of six times, as shown in Figure 17-18.



**Figure 17-18** The JLifeCycle JApplet after minimizing and restoring twice

- Click the **Press** button. The count for the `actionPerformed()` method is now 1, and `actionPerformed()` calls `display()`, so `countDisplay` is now 7, as shown in Figure 17-19.



**Figure 17-19** The JLifeCycle JApplet after minimizing and restoring twice, and then pressing the button

- Continue to minimize, maximize, and click the **Press** button. Note the changes that occur with each activity until you can correctly predict the outcome. Notice that the `destroy()` method is not executed until you close the applet, and then it is too late to observe an increase in `countDestroy`.
- Close the Applet Viewer.

## Displaying Images

In the next steps, you will add an animated image to an applet.

### To add an animated image to an applet:

- Open a new file in your text editor, and then enter the first few lines of the JMonkey JApplet:
 

```
import java.awt.*;
import javax.swing.*;
public class JMonkey extends JApplet
{
```
- Declare an `ImageIcon` and initialize it with the `monkey.gif` file that is stored in your downloadable student files. The file contains an animated image of a chimpanzee shaking its head from side to side. Declare variables to hold the width and height of the image, the content pane for the applet, and horizontal and vertical placement positions.



```
private ImageIcon image = new ImageIcon("monkey.gif");
private int width, height;
Container con = getContentPane();
int x = 30;
int y = 30;
```

- Write the `init()` method to set the layout manager and get the width and height of the image.

```
public void init()
{
    con.setLayout(new FlowLayout());
    width = image.getIconWidth();
    height = image.getIconHeight();
}
```

- The `paint()` method calls the parent's method, then draws a string and draws the image 20 pixels lower. Add the method shown below, and then add a closing curly brace for the class.

```
public void paint(Graphics g)
{
    super.paint(g);
    g.drawString("No, no, no", x, y);
    g.drawImage(image.getImage(), x, y + 20,
        width, height, this);
}
```

- Save the file as **JMonkey.java** and compile it.
- Write an HTML document to host the applet as follows:

```
<html>
<object code = "JMonkey.class" width = 200
    height = 150>
</object>
</html>
```

- Save the HTML document as **TestJMonkey.html**. Run the applet. The output should look like Figure 17-20. On your screen, you will see the animated monkey move.



**Figure 17-20** Execution of the JMonkey applet

## Playing Sounds

Next, you will use the `loop()` method and an `AudioClip` to play a sound continually in an applet. You will also create and add a `Graphics2D` object.

### To play a sound and add a `Graphics2D` object in a `JApplet`:

- Open a new file in your text editor, and then enter the first few lines of the `JSoundJApplet`:

```
import java.awt.*;
import java.applet.*;
import javax.swing.*;
public class JSound extends JApplet
{
```

2. Enter the following statement to declare an AudioClip object named sound:  
**AudioClip sound;**

3. Create the `init()` method and an AudioClip object to play the `mysteryTune.au` sound file by entering the following code:

```
public void init()
{
    sound = getAudioClip(getCodeBase(), "mysteryTune.au");
}
```

You can find the `mysteryTune.au` file in the `Chapter.17` folder of your downloadable student files.

4. Create the following `start()` method. This method uses the `loop()` method to play the `mysteryTune.au` sound file continually:

```
public void start()
{
    sound.loop();
}
```

5. Create the following `stop()` method to halt the `mysteryTune.au` sound file:

```
public void stop()
{
    sound.stop();
}
```

6. Create a Graphics object using `paint(Graphics g)`, and then use a cast to change the graphics context to a Graphics2D object. Use the `drawString()` method to create a message that appears on the screen while the JApplet plays. Add a closing curly brace for the class.

```
public void paint(Graphics g)
{
    super.paint(g);
    Graphics2D g2D = (Graphics2D)g;
    g2D.drawString("Listen to the mystery tune ",
        10, 10);
}
}
```

7. Save the file as **JSound.java**, and then compile it.
8. Open a new file in your text editor, and then enter the following HTML document to test the JApplet:

```
<html>
<object code = "JSound.class" width = 200 height = 50>
</object>
</html>
```

9. Save the HTML document as **TestJSound.html**, and then run it using the **appletviewer TestJSound.html** command. The output should look like Figure 17-21. If speakers are installed on your system and they are on, you should also be able to hear sound playing continually.



**Figure 17-21** Output of the JSound JApplet

## Don't Do It

- Don't forget a matching closing tag for every opening tag in an HTML document.
- Don't forget to use the .class extension with the name of a JApplet you want to execute from an HTML document.
- Don't add a main() method to a JApplet; it will not execute automatically like it does in an application.
- Don't try to execute an applet using the java command. An applet doesn't contain a main() method and won't execute like an application.

## Key Terms

An **applet** is a Java program that is called from another application.

**JApplet** is a Swing class from which you can inherit to create your own applet.

**HTML**, or **Hypertext Markup Language**, is a simple language used to create Web pages for the Internet.

**Extensible Hypertext Markup Language (XHTML)** is an extension of HTML.

**Applet Viewer** is a program that comes with the JDK and allows you to view applets without using a Web browser.

The **appletviewer command** allows you to view an applet in a viewing program that comes with the JDK.

A **Web browser** is a program that allows you to display HTML documents on your computer screen.

A **sandbox** is a safe area in which a program can run without causing harm to other areas of a system.

**Tags** are HTML commands.

The tag that begins every HTML document is **<html>**.

The tag that ends every HTML document is **</html>**.

**Tag attributes**, sometimes referred to as arguments, promote activity or describe the features of an HTML tag.

The **init()** method is the first method called in any applet.

The **start()** method executes after the `init()` method, and it executes again every time the applet becomes active after it has been inactive.

The **stop()** method is invoked in an applet when a user leaves a Web page (perhaps by minimizing a window or traveling to a different Web page).

Within an applet, the **destroy()** method is called when the user closes the browser or Applet Viewer.

**Multimedia** describes the use of sound, images, graphics, and video in computer programs.

An **image** is a likeness of a person or thing.

**Lossless data compression** is a set of rules that allows an exact replica of data to be reconstructed from a compressed version.

## Chapter Summary

- An applet is a program that is called within another application—often a Web browser or a program called the Applet Viewer. Applets descend from the `JApplet` class and do not contain a `main()` method.
- To view an applet, it must be called from another document written in Hypertext Markup Language (HTML), which is a simple language used to create Web pages for the Internet. When you create an applet, you write it in Java, save it with a `.java` file extension, compile it, and write an HTML document that includes a statement to call your compiled Java class. You then load the HTML document into a Web browser or run the Applet Viewer program, which in turn uses the HTML document.
- With an applet, the browser calls several methods automatically at different times. The five methods that are included in every applet are `init()`, `start()`, `paint()`, `stop()`, and `destroy()`. You can override any of those methods within a `JApplet` that you write.
- When you write a `JApplet`, you can add components, use fonts and colors, change the layout manager, and add event listeners, in much the same way you do in a `JFrame`.
- An applet's `paint()` method is always called after the `init()` and `start()` methods execute. It is also called if an applet needs repainting. When a Web page containing a `JApplet` is loaded in the browser, or when you run the `appletviewer` command within an HTML document that calls a `JApplet`, the applet's `init()` method executes. The `start()` method executes after the `init()` method, and it executes again every time the applet becomes active after it has been inactive. When a user leaves a Web page, the `stop()` method is invoked. The `destroy()` method is called when the user closes the browser or Applet Viewer.

- Multimedia describes the use of sound, images, graphics, and video in computer programs. Image formats supported by Java include Graphics Interchange Format (GIF), Joint Photographic Experts Group (JPEG), and Portable Network Graphics (PNG). The `Image` class provides many of Java's image capabilities. You can also use the `ImageIcon` class to create images in your applications and applets.
- Java programs can play audio clips on computers that have speakers and a sound card. Supported sound formats include the Windows Wave file format (.wav), Sun Audio file format (.au), and Music and Instrument Digital Interface file format (.midi or .mid). The simplest way to retrieve and play a sound is to use the `play()` method of the `Applet` class.

## Review Questions

1. An applet is like a Java application in all of the following ways *except* \_\_\_\_\_.
  - a. you save it with a .java file extension
  - b. you compile it into bytecode, creating a file with a .class extension
  - c. it can contain decisions, loops, arrays, and all the other language elements of Java
  - d. it requires a `main()` method
2. How is a `JApplet` different from an application that instantiates a `JFrame`?
  - a. `JFrames` use graphics.
  - b. `JApplets` run from another program.
  - c. `JFrames` are larger than `JApplets`.
  - d. The user cannot close a `JApplet`; the program must issue a command to do so.
3. A program that allows you to display HTML documents on your computer screen is a \_\_\_\_\_.
  - a. search engine
  - b. compiler
  - c. browser
  - d. server
4. HTML contains commands that allow you to do all of the following except \_\_\_\_\_.
  - a. add `JButtons` to `JApplets`
  - b. format text on a Web page
  - c. import graphic images to a Web page
  - d. link your page to other Web pages
5. Pairs of HTML commands are called \_\_\_\_\_.
  - a. tickets
  - b. labels
  - c. tags
  - d. keywords

6. The name of any applet called using code within an HTML document must use the extension \_\_\_\_\_.
  - a. .exe
  - b. .code
  - c. .java
  - d. .class
7. Which JApplet method can you override in your extended version?
  - a. `init()`
  - b. `stop()`
  - c. `paint()`
  - d. all of the above
8. A JApplet is a(n) \_\_\_\_\_.
  - a. Container
  - b. Component
  - c. Object
  - d. all of the above
9. The first method called in any JApplet is the \_\_\_\_\_ method.
  - a. `init()`
  - b. `start()`
  - c. `begin()`
  - d. `main()`
10. A JApplet's `init()` method is closest in purpose to a JFrame's \_\_\_\_\_.
  - a. `main()` method
  - b. `actionPerformed()` method
  - c. `start()` method
  - d. constructor
11. Which of the following JApplet methods is likely to execute the greatest number of times?
  - a. `init()`
  - b. `start()`
  - c. `destroy()`
  - d. `main()`
12. The `paint()` method is automatically called \_\_\_\_\_.
  - a. before the `init()` method
  - b. after the `start()` method
  - c. from the `actionPerformed()` method
  - d. never
13. The `start()` method called in any JApplet is called \_\_\_\_\_.
  - a. as the first method when an applet starts
  - b. when the user closes the browser
  - c. when a user revisits an applet
  - d. when a user leaves a Web page
14. To respond to user events within a JApplet, you must \_\_\_\_\_.
  - a. prepare the applet to accept event messages
  - b. import the `java.applet.*` package
  - c. tell your applet how to respond to events
  - d. accomplish both a and c

15. When a user leaves a Web page, the JApplet method that executes is \_\_\_\_\_.
  - a. stop()
  - b. destroy()
  - c. kill()
  - d. exit()
16. \_\_\_\_\_ describes the use of sound, images, graphics, and video in computer programs.
  - a. Inheritance
  - b. Multimedia
  - c. Art
  - d. Graphics
17. Image formats supported by Java include all of the following except \_\_\_\_\_.
  - a. GIF
  - b. JPEG
  - c. MIDI
  - d. PNG
18. Unlike using the Image class, objects of the ImageIcon class \_\_\_\_\_.
  - a. are harder to work with
  - b. cannot be extended
  - c. can be placed on components such as JButtons
  - d. cannot be created by calling the class constructor
19. The Applet class method that retrieves sound is \_\_\_\_\_.
  - a. sound()
  - b. music()
  - c. record()
  - d. play()
20. The method that plays a sound repeatedly is \_\_\_\_\_.
  - a. play()
  - b. loop()
  - c. repeat()
  - d. continue()

## Exercises

For each JApplet you create in the following exercises, create an HTML host document named **Test** plus the JApplet name. For example, the host document for the **JNumberOne.java** file is named **TestJNumberOne.html**.

1. Create a JApplet with a JButton labeled “Who’s number one?” When the user clicks the button, display your favorite sports team in a large font. Save the file as **JNumberOne.java**.
2.
  - a. Create a JApplet that asks a user to enter a password into a JTextField and to then press Enter. Compare the password to *Rosebud*; if it matches exactly, display “Access Granted”. If not, display “Access Denied”. Save the file as **JPasswordA.java**.
  - b. Modify the password applet in Exercise 2a to ignore differences in case between the typed password and *Rosebud*. Save the file as **JPasswordB.java**.
  - c. Modify the password applet in Exercise 2b to compare the password to a list of five valid passwords: *Rosebud*, *Redrum*, *Jason*, *Surrender*, or *Dorothy*. Save the file as **JPasswordC.java**.

3. Create a `JApplet` that contains a `JLabel` and `JButton`. When the user clicks the `JButton`, change the font typeface, style, and size on the `JLabel`. Save the file as **`JChangeFont.java`**.
4. Create a `JApplet` that contains a `JButton` and a `JTextField`. When the user clicks the `JButton`, display “Today is ”, the date, and the time in the `JTextField`. Save the file as **`JDateAndTime.java`**.
5. Create a `JApplet` that contains two `JTextFields`, a `JButton`, and three `JLabels`. When the user types an employee’s first and last names (separated by a space) in a `JTextField`, the employee’s job title is displayed in a second `JTextField`. Include two `JLabels` to describe the `JTextFields` used for data entry, and include a third `JLabel` that holds the employee’s title or an error message if no match is found for the employee. Use parallel arrays to store the employees’ names and job titles. Save the file as **`JEmployeeTitle.java`**.
6. Create a `JApplet` that contains two parallel arrays that contain at least five employees’ names and jobs. Allow the user to enter either a title or a name and to click a `JButton` to display the other. Include a `JLabel` to describe each `JTextField`. Save the file as **`JEmployeeTitle2.java`**.
7. Create a `JApplet` that initially displays a single `JButton`. When the user clicks the `JButton`, display a `JLabel` that prompts the user to enter an integer, a `JTextField` into which the user can type the integer, and a second `JButton` that contains the text *Double me*. When the user clicks the second button, the integer is doubled and the answer is displayed in the `JTextField`. Save the file as **`JDouble.java`**.
8.
  - a. Create a payroll `JApplet` named `JCalculatePay` that allows the user to enter two `double` values: hours worked and an hourly rate. When the user clicks a `JButton`, gross pay is calculated. Display the result in a `JTextField` that appears on the screen only after the user clicks the `JButton`. Save the file as **`JCalculatePay.java`**.
  - b. Modify the payroll applet created in Exercise 8a so that federal withholding tax is subtracted from gross pay based on the values in Table 17-1. Display the gross pay, tax amount, and net pay. Save the file as **`JCalculatePay2.java`**.

Income (\$)	Withholding %
0 to 99.99	10
100.00 to 299.99	15
300.00 to 599.99	21
600.00 and up	28

**Table 17-1** Withholding percentages based on income



9. Write a `JApplet` that uses the `ImageIcon` class to place image icon objects on four `JButtons`. Download any free JPEG or GIF files from the Internet; if necessary, reduce the size of the images to approximately 30 by 30 pixels. Alternatively, you can use the four files named `up.jpg`, `down.jpg`, `left.jpg`, and `right.jpg` in your downloadable student files. Each time a `JButton` is clicked, display a different message below the `JButtons`. Save the file as **`JButtonIcons.java`**.
10. Create a `JApplet` that paints an `ImageIcon` the first time its `paint()` method is called, and then randomly draws small filled ovals in the background color over the image each time a `JButton` is clicked. The resulting effect is that the image seems to be erased by an increasing number of small overlapping ovals. For example, if you place an `ImageIcon` at the coordinates contained in variables named `startPosX` and `startPosY`, you can create a series of 15-by-10 filled ovals placed randomly on the `ImageIcon`'s surface using the following for loop:

```
for(int count = 0; count < 20; ++count)
{
    int x = (int) (Math.random() * imageWidth) + startPosX;
    int y = (int) (Math.random() * imageHeight) + startPosY;
    g.fillOval(x, y, 10, 10);
}
```

Save the file as **`JEraseImage.java`**.
11. Create a `JApplet` for Business Associates, a consulting firm whose motto is “Let Business Associates take care of your business.” Include two `JButtons`: clicking one `JButton` plays the tune “Taking Care of Business” continuously, and clicking the other stops the music. You can find the `business.mid` file in your downloadable student files. Save the file as **`JBusiness.java`**.
12. Write an applet that prompts the user for a color name. If it is not red, white, or blue, throw an `Exception`. Otherwise, change the applet's background color appropriately. Create an HTML document to host the `JApplet`. Save the file as **`RWBApplet.java`**.
13. Write a `JApplet` that uses a `JPanel` to show the messages “Mouse Entered Applet” and “Mouse Exited Applet” when the mouse enters and exits the applet. Also, when the mouse is clicked on the applet, a message “Mouse Clicked Here” should appear near the clicked location. Save the file as **`JMouse.java`**.
14. Patty's Party Planning Service wants you to create a `JPartyPlanner` applet that lets a user estimate the cost of a party. The service uses a sliding fee scale so that the per-guest cost decreases as the total number of invited guests increases. Table 17-2 shows the fee structure.

Number of Guests	Cost per Guest (\$)
1 to 24	27
25 to 49	25
50 to 99	22
100 to 199	19
200 to 499	17
500 to 999	14
1000 and over	11

**Table 17-2** Cost per guest for parties

The applet lets the user enter the number of anticipated guests. The user can click either of two `JButtons`: one to display the fee per person and another to display the fee for the party (the cost per person times the number of guests). The user can continue to request fees for a different number of guests and view the results for any length of time before making another request or leaving the page. When the user leaves the page, erase the last number of requested guests and ensure that the next user starts fresh with a blank `JTextField` that holds the number of guests. Save the file as **JPartyPlanner.java**.



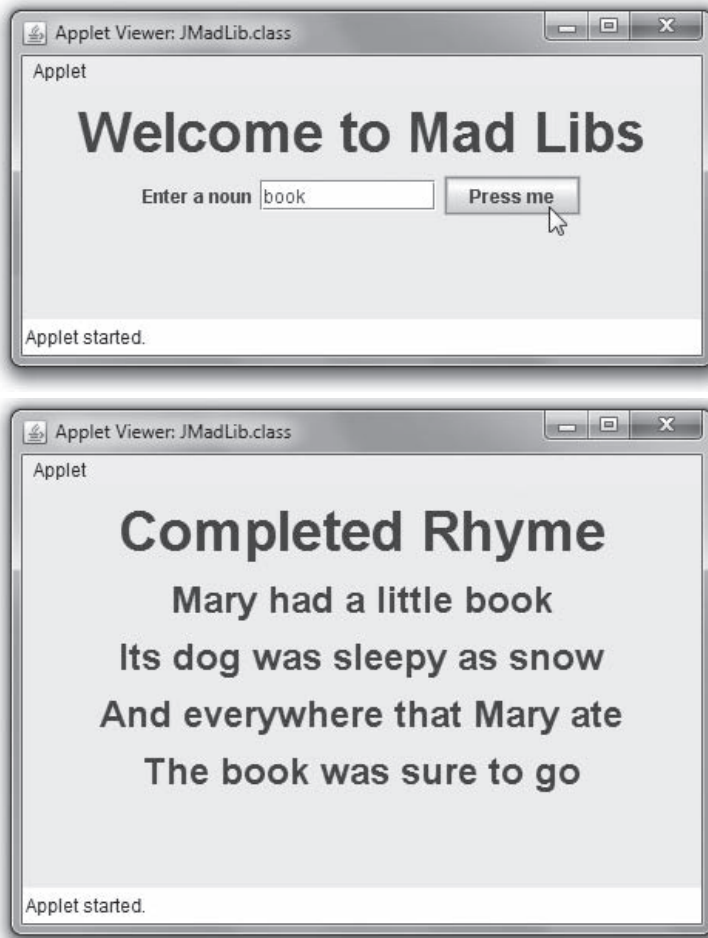
### Debugging Exercise

15. Each of the following files in the Chapter.17 folder of your downloadable student files has syntax and/or logic errors. In each case, determine the problem and fix the program. After you correct the errors, save each file using the same filename preceded with Fix. For example, `DebugSeventeen1.java` will become `FixDebugSeventeen1.java`. You can test each applet with four downloadable student files named `TestFixDebugSeventeen1.html` through `TestFixDebugSeventeen4.html`.
- `DebugSeventeen1.java`
  - `DebugSeventeen2.java`
  - `DebugSeventeen3.java`
  - `DebugSeventeen4.java`



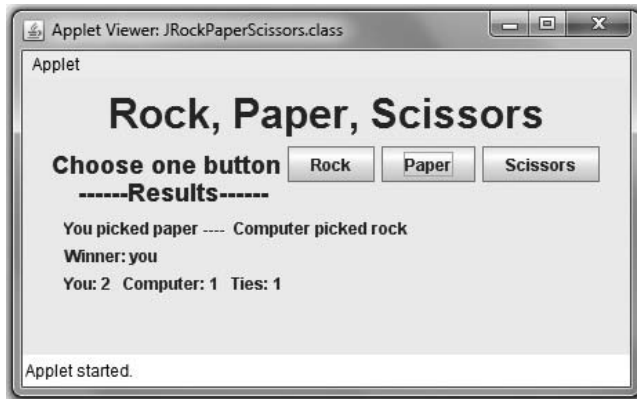
### Game Zone

16. In Chapter 2, you created a *Mad Libs* game in which the user entered several words out of context that were then inserted into a rhyme or story, producing humorous effects. Modify the game so it becomes an applet. In turn, prompt the user for each required word. After all the words are entered, display the completed rhyme or story. Figure 17-22 shows the first and last screens displayed during a typical execution. Save the applet as **JMadLib.java**.



**Figure 17-22** First and last screens in a typical execution of JMadLib applet

17. In Chapter 5, you created a Rock Paper Scissors game. Now create it as a JApplet in which the user can click one of three buttons labeled “Rock”, “Paper”, or “Scissors”. The computer’s choice is still randomly generated. Figure 17-23 shows a typical execution after the user has played a few games. Save the applet as **JRockPaperScissors.java**.



**Figure 17-23** Typical execution of JRockPaperScissors applet

18. In earlier chapters, you created and used a `Card` class in which each object represents a playing Card, and in Chapter 8 you constructed a deck of 52 unique Cards. Create a `JApplet` that uses such a deck. Start the player with a \$10 stake. Randomly deal a card to the computer and allow the player to make one of four bets:
- \$5 that the player's card will be higher than the computer's card
  - \$10 that the player's card will be higher than the computer's card
  - \$5 that the player's card will be lower than the computer's card
  - \$10 that the player's card will be lower than the computer's card

After the player makes a bet, deal the player's card and add or subtract the correct amount from the player's winnings based on the results. When the computer's and player's cards are the same value, the computer wins. The game ends when the first of these events happens:

- The player goes broke (the winnings go to \$0 or below).
- The player wins \$100.
- All 52 cards are exhausted without a winner.

As shown in the game in progress in Figure 17-24, when the player is making a bet, enable four betting buttons. After the player makes a bet, disable the betting buttons while the player examines the outcome, and enable an OK button. When the player is ready to resume play and clicks OK, disable the OK button and, if the game isn't over, enable the four betting buttons. Save the game as **JCardBet.java**.

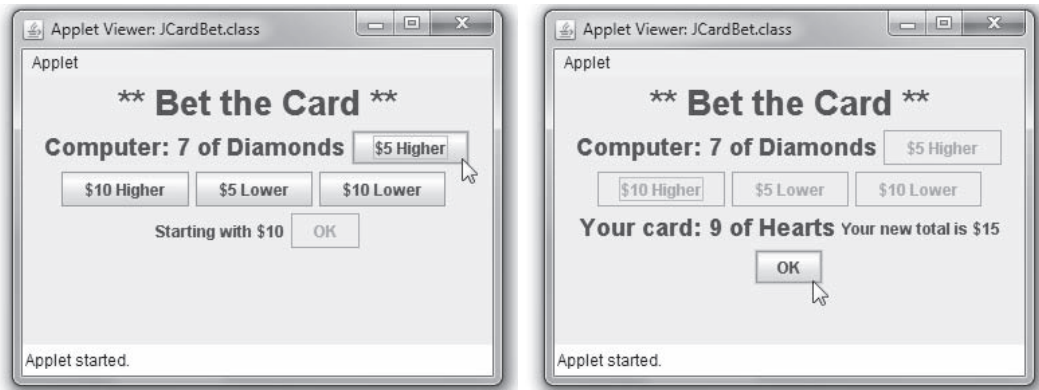


Figure 17-24 Typical execution of JCardBet applet

19.
  - a. In Chapters 10 and 11, you created an `Alien` class and `Martian` and `Jupiterian` classes that descend from it. Add a `draw()` method for each child class. The `draw()` method accepts a `Graphics` object and `x-` and `y-` starting coordinates. The method draws the Aliens in any way you choose, using lines, ovals, rectangles, and so on. Using the `drawString()` method, include a description that names each drawing. Save the files as **Martian.java** and **Jupiterian.java**.
  - b. Create an applet that instantiates a `Martian` and a `Jupiterian`. In the applet's `paint()` method, draw each type of `Alien`. Save the file as **JDemoAliens.java**. Figure 17-25 shows some sample Aliens, but your Aliens might look very different.

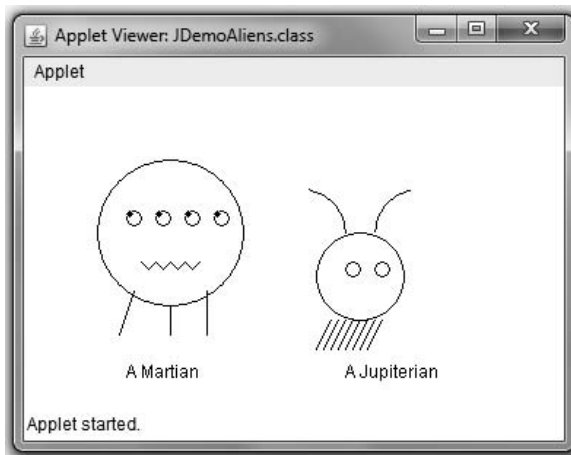


Figure 17-25 Some aliens

- c. Create an applet that contains an Alien Hunt game. Place eight numbered buttons in the applet. Randomly assign `Martians` to six of the buttons and `Jupiterians` to two.

(*Hint:* You do not need to create an `Alien` array; you can simply create an array that randomly contains `0`s and `1`s, representing `Martians` and `Jupiterians`.) The object of the game is to find all the `Martians` before finding both `Jupiterians`. When a user clicks a button, display the `Alien` represented by the button. If the user clicks two `Jupiterians` before clicking six `Martians`, the player loses the game. When this happens, display two `Jupiterians` and a message telling the user that Earth has been destroyed. Disable any button after it has been selected. Save the game as **`JAlienHunt.java`**.

20. a. In Chapter 4, you created a `Die` class that you can use to instantiate objects that hold one of six values. Create a `GraphicDie` class that descends from `Die` but adds a `drawDie()` method that draws a representation of the die on the screen. Design the method so it accepts a `Graphics` object as well as `x`- and `y`-coordinate positions where the drawing should be placed. Create the drawing of a `Die` based on its value and using the `drawRect()` and `fillOval()` methods. Save the file as **`GraphicDie.java`**.
- b. Create a `JGraphicDie` `JApplet` that instantiates a `GraphicDie` object. In the `JApplet`'s `paint()` method, pass the method's `Graphics` object and two values to the `GraphicDie` object's `drawDie()` method. Save the file as **`JGraphicDie.java`**.
- c. In Chapter 8, you created a `FiveDice3` game in which a player's random roll of five dice is compared to the computer's roll and a winner is determined. Now create an applet that plays the game. At each roll, initiated by a player's button click, display the player's five dice and the computer's five dice. Save the file as **`JFiveDice.java`**. Figure 17-26 shows a typical game.

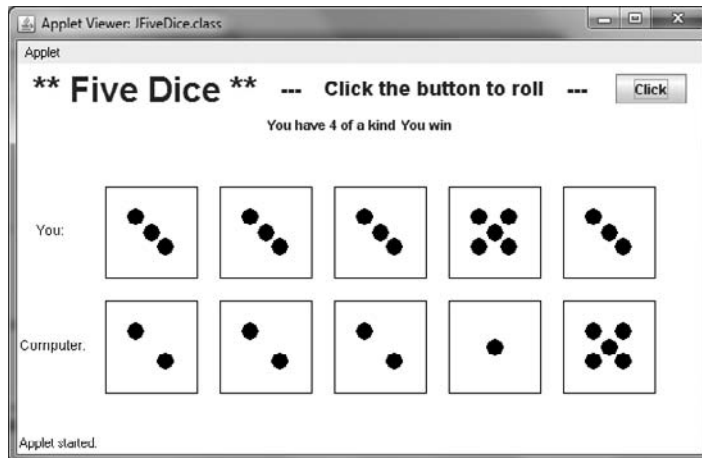


Figure 17-26 The `JFiveDice` applet



# Working with the Java Platform

In this appendix, you will:

- ⦿ Configure Windows to work with the Java SE Development Kit
- ⦿ Use Notepad to save and edit source code
- ⦿ Use TextPad to work with Java

## Configuring Windows to Work with the Java SE Development Kit

Several versions of Java are available for free at the Java Web site (<http://java.sun.com>). The official name of the most recent version is Java Platform, Standard Edition 7, often called **Java SE 7** for short. Two version numbers (for example, 1.7.0 and 7) are used to identify this release of the Java Platform. Version 7 is the product version and 1.7.0 is the developer version. The number 7 is used to reflect Java's evolving level of maturity. As new versions containing advanced features emerge, you can download them. Alternatively, you can use the version that comes with this book.



Java's Web site was <http://java.sun.com> before Java was purchased by Oracle. Now the Web site is <http://www.oracle.com/technetwork/java/index.html>. However, the shorter URL redirects you to the longer one, so the shorter URL is used throughout this book. Each new version of Java has a code name. The code name for version 7 is Dolphin. The name for version 5 was Tiger, and the name for version 6 was Mustang.



Over the years, Java has been inconsistent in numbering new versions. Before version 6, the standard editions were called JDK 1.0.3, JDK 1.1.2 through 1.1.8, J2SE 1.2.0 through 1.4.2, and J2SE 5.0. With versions 6 and 7, Java is attempting to simplify the name and number changes. Java sometimes adds a "half step" for minor revisions in a version, such as JDK 1.7.0\_05.

The different names for Java versions are somewhat confusing, and frequently misused. If you download Java to use with this book, you want to acquire the Java Standard Edition (SE) Development Kit, also known as the **JDK**. Java also supports the **Java Enterprise Edition (EE)**, which includes all of the classes in the Java SE, plus a number of classes that are more useful to programs running on servers than on workstations. The Java EE Development Kit is known as **SDK**. The names of the development kits have changed frequently; originally, JDK meant "Java Development Kit," but that interpretation was used with the earliest Java versions and is no longer used officially.



The **Java Micro Edition (ME)** is another Java platform, which is used for small devices such as PDAs (personal digital assistants), cell phones, and other consumer appliances.

To configure your Windows operating system with the JDK, you must add the Java bin directory to the command path of your operating system (OS). That way, your OS will know where to look for the Java commands that you use.

One way to update the OS path for Windows is to edit or set the OS path in the `autoexec.bat` file. This file is automatically executed every time you start your computer. A simpler and less error-prone alternative is to type two commands at the OS prompt when you want to begin a session of working on Java programs. (These two commands are described later in this appendix.)

You do not need to be an operating system expert to issue operating system commands. Learning just a few commands allows you to create and run all the examples in this book.



## Finding the Command Prompt

To locate the command prompt on your Windows computer, click Start, point to All Programs, point to or click Accessories, and then click Command Prompt.



In earlier versions of Windows, the console window was called the *MS-DOS (Microsoft Disk Operating System) prompt*, or more simply, the *DOS prompt*. Many people still use this term instead of *command prompt*.

## Command Prompt Anatomy

The Windows command prompt contains at least a disk drive name followed by a colon, a backslash, and a greater-than sign (for example, `C:\>`). You might also see folder or directory names within the command prompt just before the greater-than sign, as shown in the following examples:

```
C:\Documents and Settings>
```

```
C:\Documents and Settings\Administrator>
```

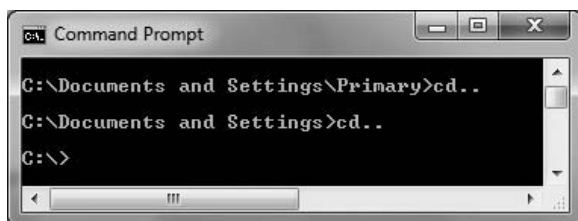
Each directory in the path is separated by a backslash.

## Changing Directories

You can back up one directory level by typing `cd` for “change directory,” followed by two periods:

```
cd..
```

For example, if your OS prompt contains `C:\Documents and Settings\Primary>` and you type `cd..`, the command prompt changes to `C:\Documents and Settings>`. If you type `cd..` again, the prompt changes to `C:\>`, indicating the root directory. Figure A-1 shows this progression.



**Figure A-1** Results following two `cd..` commands

When you have multiple directories to back through, it is easier to use the following command:

```
cd\
```

This takes you immediately to the root directory instead of backing up one level at a time.

At the command prompt, you can change to another disk drive by typing its name and a colon, then pressing Enter. For example, the following command changes the command prompt to refer to the A drive:

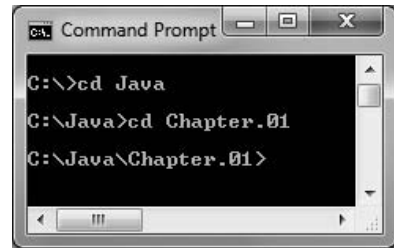
```
A:
```

You can change the directory by typing `cd` followed by the name of the directory. For example, if you have a folder named `Java` and it contains a folder named `Chapter.01`, you can change the command prompt to the `Chapter.01` folder by backing up to the root directory and typing the following:

```
cd Java
cd Chapter.01
```

As shown in Figure A-2, the command prompt now reads `C:\Java\Chapter.01>`. When you compile and execute your Java programs, you should start from the command prompt where the files are stored.

When your command prompt display is filled with commands, it can look confusing. If you want, you can type `cls` (for Clear Screen) to remove old commands.



**Figure A-2** Changing to the `Java\Chapter.01` directory from the root directory

## Setting the `class` and `classpath` Variables

When you start a Java session, you might need to set the `class` and `classpath` options. These settings tell the operating system where to find the Java compiler and your classes. If you or someone else has altered your `autoexec.bat` file to contain these commands, you do not need to type them. Otherwise, every time you want to compile and execute Java programs, you need to type statements similar to the following:

```
path = c:\program files\java\jdk1.7.0\bin
set classpath=.
```

After you have typed these statements, you can compile and run as many Java programs as you want without typing these commands again. You must type them again if you close the Command Prompt window or restart your computer.

The first statement sets the `path` and allows the OS to recognize the `javac` command you use when compiling programs. Consider the following example:

```
path = c:\program files\java\jdk1.7.0\bin
```

This example assumes that you are using JDK 1.7.0 and that it is stored in the `java` folder in the program files folder. These are the defaults when you download Java from the Java Web site; if you installed Java in a different location, you need to alter the command accordingly.

The command `set classpath=.` tells Java to find your compiled classes in the current directory when you execute your applications and applets. There must be no space between `classpath` and the equal sign, or between the equal sign and the period.

After you set the path correctly, you should be able to use the `javac` command. If you attempt to compile a Java class and see an error message that `javac` is not a recognized command, either Java was not properly installed or the path command was incorrect. If classes compile successfully but do not execute, you might have entered the `classpath` command incorrectly.

## Changing a File's Name

When working through the examples in this book, you will often find it convenient to change the name of an existing file—for example, when you want to experiment with altering code without losing the original version, or if you find that when you previously saved a file, you mistyped a filename so that it did not match the class name within the `.java` file you created. You can take at least three approaches:

- Open the existing file using the appropriate software application (for example, Notepad), click File on the menu bar, and then click Save As. Select the folder you want, then type a new filename for the file. Now you have two versions—one with the old name and one with the new.
- In Windows, open Computer and locate the misnamed file. Select the file and then click the filename. (Do not double-click the filename unless you want to open the file.) You can then edit the filename by using a combination of the Backspace, Delete, and character keys. Press Enter when the filename is correct.
- At the command prompt, use the `rename` command. You type `rename`, a space, the old filename, another space, and the new filename. For example, to change a file named `xyz.java` to `abc.java`, type the following at the command prompt for the directory containing the existing file:

```
rename xyz.java abc.java
```

## Compiling and Executing a Java Program

At the command prompt, change from the default drive prompt to the drive where your application is stored. Then change the directory (or folder) to the directory that holds your application.

To compile an application or applet, you type the `javac` command to start the Java compiler, then type a space and the complete name of the `.java` file—for example, `First.java`. If the application doesn't compile successfully, the path might not be set correctly to the Java JDK bin directory where the `javac.exe` file is located. Also, you might have failed to use the same spelling as the Java filename.

When you compile a .java file correctly, the Java compiler creates a .class file that has the same filename as the .java file. Thus, a successful compilation of the First.java file creates a file named First.class. To run a Java application, you use the `java` command and the class name without the .class extension. For example, after an application named First.java is compiled, producing First.class, you execute the program using the following command:

```
java First
```

After the program executes, control is returned to the command prompt. If a program does not end on its own, or you want to end it prematurely, you can press `Ctrl+C` to return to the command prompt.

After you compile a Java program, you can execute it as many times as you want without recompiling. If you change the source code, you must save and compile again before you can see the changed results in an executed application.



When you are testing a Java program, you often issue the commands to compile and execute it many times before you are satisfied with the results. If you press the Up Arrow key at the command line, the previous commands appear in reverse succession. When you find the command you want to repeat, just press Enter.

## Using Notepad to Save and Edit Source Code

You can use the Windows Notepad text editor to save and edit the source code for Java programs. To start Notepad using Windows, click the Start menu, point to All Programs, point to or click Accessories, and click Notepad. After you start Notepad, you can enter and edit the code just as you would with any text editor.

Saving source code in Notepad requires that the Java source file be saved with a .java extension. Because Java is case sensitive, you must save a file with the proper capitalization. If the class name of the file and the filename do not match in both spelling and case, you receive an error when you attempt to execute compiled source code. The default extension for Notepad documents is .txt. To create a file with a .java extension, use Save As, locate the folder you want, and type the filename. In Windows 7 or Vista, you can simply type the filename. In older Windows operating systems, type the filename with double quotation marks around it, as in "First.java". This ensures that the file is not saved as "First.java.txt". Then click Save.

## Using TextPad to Work with Java

As an alternative to Notepad, you can use TextPad—a text editor that includes many features helpful to Java programmers. You can download a trial version from [www.textpad.com](http://www.textpad.com). Unlike Notepad, TextPad is not included with Windows; to install TextPad, run the setup file after downloading it from the TextPad Web site, and then respond to the dialog box options. Because you download a trial version, you should purchase TextPad if you decide to use it beyond the trial period. Note that TextPad runs only under the Windows operating system. If

you are not using Windows, you can use the text editor that comes with your operating system, or you can search the Web to find a text editor that better suits your needs.

To enter and edit source code in TextPad, you can use the same techniques that you use with any other Windows text editor. In short, you can use the standard Windows shortcut keystrokes and menus to enter, edit, and save your code. You can use the File menu to open and close files. You can use the Edit menu to cut, copy, and paste text, and you can use the Search menu to find and replace text. In addition, TextPad color-codes the source files so it is easier to recognize the Java syntax. TextPad also makes it easier to save Java files with the proper capitalization and extension. To compile the current source code, you can select the Compile Java command from the Tools menu. If the source code does not compile cleanly, TextPad displays a Command Results window, including line numbers that identify the source of problems. With TextPad, you can choose to display line numbers in your code.

---

## Key Terms

**Java SE 7** is the most recent version of Java. The full, official name is Java Platform, Standard Edition 7.

The **JDK** is the Java Standard Edition Development Kit.

The **Java Enterprise Edition (EE)** includes all of the classes in the Java SE, plus a number of classes that are more useful to programs running on servers.

The **SDK** is the Java EE Development Kit.

The **Java Micro Edition (ME)** is another Java platform, which is used for small devices such as PDAs, cell phones, and other consumer appliances.

*This page intentionally left blank*

# Learning About Data Representation

In this appendix, you will:

- ⦿ Work with numbering systems
- ⦿ Represent numeric values
- ⦿ Represent character values

## Understanding Numbering Systems

You can use devices such as computers, cell phones, microwave ovens, and automobiles without understanding how they work internally. Likewise, you can write many Java programs without understanding how the data items they use are represented internally. However, once you learn how data items are stored, you gain a deeper understanding of computer programming in general and Java in particular. You also can more easily troubleshoot some types of problems that arise in your programs.

The numbering system you know best is the **decimal numbering system**, which is based on 10 digits, 0 through 9. When you use the decimal system, no other symbols are available; if you want to express a value larger than 9, you must use multiple digits from the same pool of 10, placing them in columns. Decimal numbers are also called base 10 numbers.

When you use the decimal system, you analyze a multicolumn number by mentally assigning place values to each column. The value of the rightmost column is 1, the value of the next column to the left is 10, the next column's value is 100, and so on; you multiply the column value by 10 as you move to the left. There is no limit to the number of columns you can use; you simply add them to the left as you need to express higher values. For example, Figure B-1 shows how the value 305 is represented in the decimal system. You simply multiply the digit in each column by the value of the column, and then add the values together.

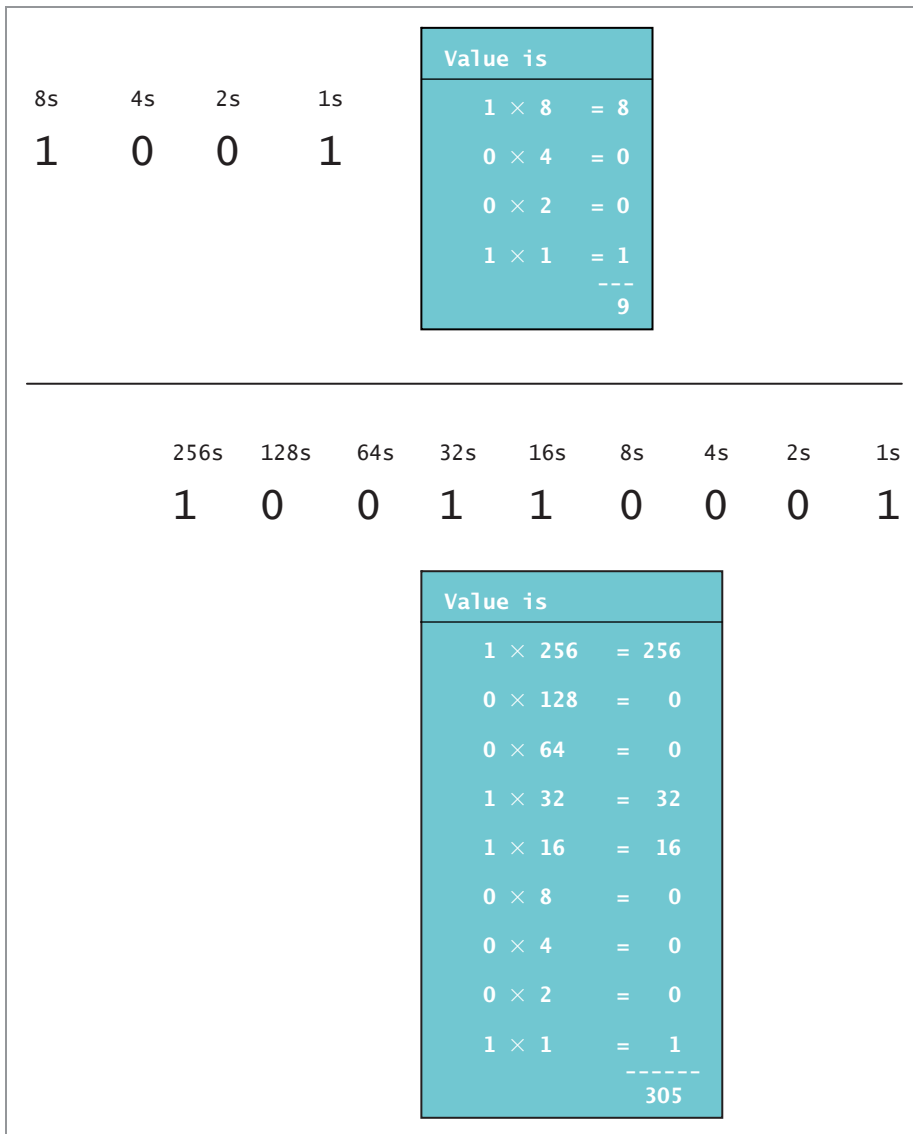
100s	10s	1s	
3	0	5	
			<b>Value is</b>
			$3 \times 100 = 300$
			$0 \times 10 = 0$
			$5 \times 1 = 5$
			-----
			305

**Figure B-1** Representing 305 in the decimal system

The **binary numbering system** works in the same way as the decimal numbering system, except that it uses only two digits, 0 and 1. When you use the binary system and you want to express a value greater than 1, you must use multiple columns because no single symbol represents any value other than 0 or 1. Instead of each new column to the left being 10 times greater than the previous column, each new binary column is only two times the value of the previous column. Binary numbers are called base 2 numbers.

For example, Figure B-2 shows how the numbers 9 and 305 are represented in the binary system. Notice that both the binary and decimal systems allow you to create numbers with 0 in one or more columns. As with the decimal system, the binary system has no limit to the number of columns—you can use as many as it takes to express a value.





**Figure B-2** Representing decimal values 9 and 305 in the binary system

A computer stores every piece of data it uses as a set of 0s and 1s. Each 0 or 1 is known as a **bit**, which is short for *binary digit*. Every computer uses 0s and 1s because all its values are stored as electronic signals that are either on or off. This two-state system is most easily represented using just two digits.

## Representing Numeric Values

In Chapter 2, you learned that a floating-point number contains decimal positions. The term *floating-point* comes from the fact that the decimal point can be at any location in the stored value, allowing a much larger range of possible values to be stored in the same amount of memory. For example, assume that a computer could store only four digits and that the decimal point had to fall after the first two. The positive values that could be stored would then range from 00.00 through 99.99. However, if the decimal point could fall anywhere, the values could range from .0000 through 9999. Computers use more storage for each value, and store negative values as well, but the principle is the same.

Because of the binary nature of computers, representing floating-point numbers is imprecise. For example, suppose you want to represent the value  $1/10$  (0.10). You could try using each of the following techniques:

- If you use two bits to store the value, only four combinations are available (00, 01, 10, and 11), so they can only represent  $0/4$ ,  $1/4$ ,  $2/4$  (or  $1/2$ ), and  $3/4$ . None of these is exactly  $1/10$ , but  $0/4$  is the closest.
- Suppose you use three bits. This allows twice as many combinations, or eight, and the closest to  $1/10$  is  $1/8$ . The approximation is closer than with two bits, but still not exact.
- Suppose you use four bits, which allows 16 combinations. The closest value to  $1/10$  is  $2/16$ . This value is no closer to  $1/10$  than you could achieve with three bits.
- Suppose you use eight bits. Now, there are 256 bit combinations from  $0/256$  through  $255/256$ . The value of  $26/256$ , at  $0.1015625$ , is closer than any of the other values so far, but it's still not exact.
- No matter how many bits you add to the representation, doubling the number of combinations each time, you can never express 0.1 exactly.

Although you cannot store 0.1 exactly, you can still display it. For example, the following two lines of code display 0.1 as expected:

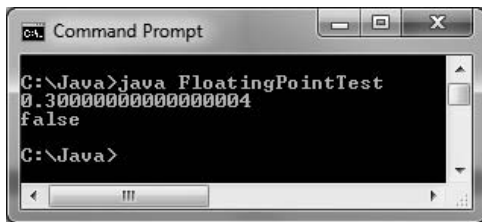
```
double oneTenth = 0.1;
System.out.println(oneTenth);
```

When Java displays a floating-point number, it always displays at least one digit after the decimal. After that, it uses only as many digits as necessary to distinguish the number from the nearest floating-point value it can represent.

However, when you use 0.1 in an arithmetic statement, the imprecision becomes evident. Figure B-3 shows a simple program that declares two variables named `oneTenth` and `threeTenths`; the variables contain the values 0.1 and 0.3, respectively. Figure B-4 shows the result of summing `oneTenth` three times and of comparing that sum to `threeTenths`. Because of floating-point imprecision, the first value is calculated to be slightly more than 0.3, so the comparison of `oneTenth + oneTenth + oneTenth` to `threeTenths` is `false`.

```
import java.util.Scanner;
public class FloatingPointTest
{
    public static void main(String[] args)
    {
        double oneTenth = 0.1;
        double threeTenths = 0.3;
        System.out.println(oneTenth + oneTenth + oneTenth);
        System.out.println(oneTenth + oneTenth + oneTenth ==
            threeTenths);
    }
}
```

Figure B-3 The FloatingPointTest class



```
Command Prompt
C:\Java>java FloatingPointTest
0.30000000000000004
false
C:\Java>
```

Figure B-4 Output of the FloatingPointTest program

For many purposes, you do not care about the small imprecisions generated by floating-point calculations, but sometimes they can make a difference. For example, several popular movies have used the idea that small amounts of extra money can be sliced off bank balances when compounding interest and then siphoned to a criminal's account. Many programmers recommend that you use the Java class `BigDecimal` when working with monetary or scientific values where precision is important. Additionally, be aware that when you test two floating-point values for equivalency, you might not get the expected results.

When precision is not an issue, but better-looking output is important, you can format the output to eliminate the small imprecisions that occur far to the right of the decimal point. Appendix C teaches you many techniques for formatting output to a desired number of decimal places.

## Representing Character Values

The characters used in Java are represented in **Unicode**, which is a 16-bit coding scheme for characters. For example, the letter *A* actually is stored in computer memory as a set of 16 zeros and ones as 0000 0000 0100 0001 (a space is inserted after each set of four digits for

readability). Because 16-digit numbers are difficult to read, programmers often use a shorthand notation called the **hexadecimal numbering system**, or base 16. The hexadecimal system uses 16 values, 0 through 9 and A through F, to represent the decimal values 0 through 15. In hexadecimal shorthand, 0000 becomes 0, 0100 becomes 4, and 0001 becomes 1, so the letter *A* is represented in hexadecimal as 0041. You tell the compiler to treat the four-digit hexadecimal 0041 as a single character by preceding it with the `\u` escape sequence. Therefore, there are two ways to store the character *A*:

```
char letter = 'A';  
char letter = '\u0041';
```



For more information about Unicode, go to [www.unicode.org](http://www.unicode.org).

The second option, using hexadecimal, is obviously more difficult and confusing than the first method, so it is not recommended that you store letters of the alphabet using hexadecimal values. However, you can produce some interesting output using the Unicode format. For example, the sequence `\u0007` produces a bell-like noise if you send it to output. Letters from foreign alphabets that use characters instead of letters (Greek, Hebrew, Chinese, and so on) and other special symbols (foreign currency symbols, mathematical symbols, geometric shapes, and so on) are available using Unicode, but not on a standard keyboard, so it may be important that you know how to use Unicode characters.



Two-digit, base-16 numbers can be converted to base-10 numbers by multiplying the left digit by 16 and adding the right digit. For example, hexadecimal 41 is 4 times 16 plus 1, or 65.

In the United States, the most widely used character set traditionally has been **ASCII** (American Standard Code for Information Interchange). The ASCII character set contains 128 characters. You can create any Unicode character by adding eight 0s to the beginning of its ASCII character equivalent. This means that the decimal value of any ASCII character is the same as that of the corresponding Unicode character. For example, *B* has the value 66 in both character sets. The decimal values are important because they allow you to show nonprintable characters, such as a carriage return, in decimal codes. Also, the numeric values of the coding schemes are used when a computer sorts numbers and strings. When you sort characters in ascending order, for example, numbers are sorted first (because their Unicode values begin with decimal code 48), followed by capital letters (starting with decimal 65) and then lowercase letters (starting with decimal 97).

Chapter 2 contains a list of Unicode values for some commonly used characters. For a complete list, see [www.unicode.org/charts](http://www.unicode.org/charts). There you will find Greek, Armenian, Hebrew, Tagalog, Cherokee, and a host of other character sets. Unicode also contains characters for mathematical symbols, geometric shapes, and other unusual characters. The ASCII character set is more limited than Unicode because it contains only letters and symbols used in the English language.

## Key Terms

The **decimal numbering system** is based on 10 digits, 0 through 9, in which each column represents a value 10 times higher than the column to its right.

The **binary numbering system** is based on two digits, 0 and 1, in which each column represents a value two times higher than the column to its right.

A **bit** is each binary digit, 0 or 1, used to represent computerized values.

**Unicode** is a 16-bit coding scheme for representing characters.

The **hexadecimal numbering system** is based on 16 digits, 0 through F, in which each column represents a value 16 times higher than the column to its right.

**ASCII** (American Standard Code for Information Interchange) is a character set widely used to represent computer data.

*This page intentionally left blank*



# Formatting Output

In this appendix, you will:

- ③ Round numbers
- ③ Use the `printf()` method
- ③ Use the `DecimalFormat` class

## Rounding Numbers

In Chapter 2 and Appendix B, you learned about the imprecision of floating-point numbers. For example, if you write a program that subtracts 2.00 from 2.20, the result is not 0.20—it is 0.200000000000000018. To eliminate odd-looking output and nonintuitive comparisons caused by imprecise calculations in floating-point numbers, you can take the approach shown in the class in Figure C-1. If you want to round a number to two decimal places, note the shaded steps in the figure:

- Multiply the value by 100. So, for example, 0.200000000000000018 becomes 20.0000000000000018.
- Add 0.5. This increases a value's whole number part by 1 if the fractional part is 0.5 or greater. For example, 41.6 would become 42.1. In this case, 20.0000000000000018 becomes 20.5000000000000018.
- Cast the value to an integer. In this case, 20.5000000000000018 becomes 20.
- Divide by 100. In this case, the value becomes 0.20.

```
public class RoundingDemo1
{
    public static void main(String[] args)
    {
        double answer = 2.20 - 2.00;
        boolean isEqual;
        isEqual = answer == 0.20;
        System.out.println("Before conversion");
        System.out.println("answer is " + answer);
        System.out.println("isEqual is " + isEqual);
        answer = answer * 100;
        answer = answer + 0.5;
        answer = (int) answer;
        answer = answer / 100;
        isEqual = answer == 0.20;
        System.out.println("After conversion");
        System.out.println("answer is " + answer);
        System.out.println("isEqual is " + isEqual);
    }
}
```

**Figure C-1** The RoundingDemo1 class

Figure C-2 shows the output of the program. Without rounding, the displayed difference between 2.20 and 2.00 is 0.200000000000000018. However, after applying the rounding technique, the result is displayed as 0.2 as expected.



```

C:\Java>java RoundingDemo1
Before conversion
answer is 0.200000000000000018
isEqual is false
After conversion
answer is 0.2
isEqual is true

C:\Java>_

```

Figure C-2 Output of the RoundingDemo1 program

As an alternative, you can use the `round()` method that is supplied with Java's `Math` class. The `round()` method returns the nearest `long` value. Figure C-3 shows a program that multiplies the `double` answer by 100, rounds it, and then divides by 100.0. The output is identical to that shown in Figure C-2.

```

public class RoundingDemo2
{
    public static void main(String[] args)
    {
        double answer = 2.20 - 2.00;
        boolean isEqual;
        isEqual = answer == 0.20;
        System.out.println("Before conversion");
        System.out.println("answer is " + answer);
        System.out.println("isEqual is " + isEqual);
        answer = answer * 100;
        long roundedAnswer = Math.round(answer);
        answer = roundedAnswer / 100.0;
        isEqual = answer == 0.20;
        System.out.println("After conversion");
        System.out.println("answer is " + answer);
        System.out.println("isEqual is " + isEqual);
    }
}

```

Figure C-3 The RoundingDemo2 class

## Using the printf() Method

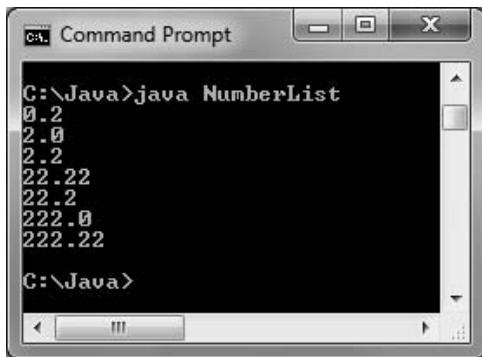
When you display numbers using the `println()` method in Java applications, it sometimes is difficult to make numeric values appear as you want. For example, in the output in Figure C-2, the difference between 2.20 and 2.00 is displayed as 0.2. By default, Java eliminates trailing zeros when floating-point numbers are displayed because they do not add any

mathematical information. You might prefer to see 0.20 because the original numbers were both expressed to two decimal places, or, in particular, if the values represent currency.

Additionally, you frequently want to align columns of numeric values. For example, Figure C-4 shows a `NumberList` application that contains an array of floating-point values. The application displays the values using a `for` loop, but as the output in Figure C-5 shows, the numbers are not aligned by the decimal point as you usually would want numbers to be aligned. Because the `println()` method displays values as `Strings`, the displayed values are left-aligned, just as series of words would be. The numeric values are accurate; they just are not attractively arranged.

```
public class NumberList
{
    public static void main(String[] args)
    {
        double[] list = {0.20, 2.00, 2.20, 22.22,
            22.20, 222.00, 222.22};
        int x;
        for(x = 0; x < list.length; ++x)
            System.out.println(list[x]);
    }
}
```

Figure C-4 The `NumberList` application



```
ca. Command Prompt
C:\Java>java NumberList
0.2
2.0
2.2
22.22
22.2
222.0
222.22
C:\Java>
```

Figure C-5 Output of the `NumberList` application

The **`System.out.printf()` method** is used to format numeric values. It is a newer Java feature that was first included in the `Formatter` class in Java 1.5.0. (This is the internal version number of the Java Development Kit; the external version number is 5.0.) Because this class is contained in the `java.util` package, you do not need to include any `import` statements to use it. The `printf()` method allows you to format numeric values in two useful ways:

- By specifying the number of decimal places to display
- By specifying the field size in which to display values



The `Formatter` class contains many formats that are not covered here. To view the details of formatting data types such as `BigDecimal` and `Calendar`, visit the Java Web site at <http://java.sun.com>.



C programmers use a `printf()` function that is very similar to Java's `printf()` method. Although the `printf()` method is used in these examples, in Java, you can substitute `System.out.format()` for `System.out.printf()`. There is no difference in the way you use these two methods.

When creating numeric output, you can specify a number of decimal places to display by using the `printf()` method with two types of arguments that represent the following:

- A format string
- A list of arguments

A **format string** is a string of characters; it includes optional text (that is displayed literally) and one or more format specifiers. A **format specifier** is a placeholder for a numeric value. Within a call to `printf()`, you include one argument (either a variable or a constant) for each format specifier.

The format specifiers for general, character, and numeric types contain the following elements, in order:

- A percent sign ( `%` ), which indicates the start of every format specifier
- An optional argument index, which is an integer indicating the position of the argument in the argument list. The integer is followed by a dollar sign. You will learn more about this option later in this appendix.
- Optional flags that modify the output format. The set of valid flags depends on the data type you are formatting. You can find more details about this feature at the Java Web site.
- An optional field width, which is an integer indicating the minimum number of characters to be written to the output. You will learn more about this option later in this appendix.
- An optional precision factor, which is a decimal point followed by a number and typically is used to control the number of decimal places displayed. You will learn more about this option in the next section.
- The required conversion character, which indicates how its corresponding argument should be formatted. Java supports a variety of conversion characters, but the three you want to use most frequently are `d`, `f`, and `s`, the characters that represent decimal (base-10 integer), floating-point (`float` and `double`), and string values, respectively.



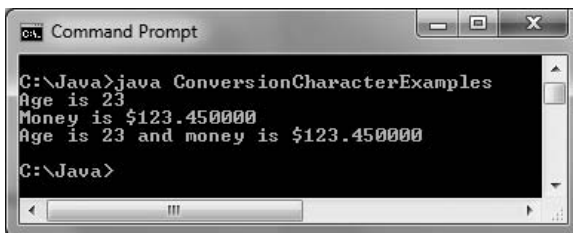
Other conversion characters include those used to display hexadecimal numbers and scientific notation. If you need these display formats, you can find more details at <http://java.sun.com>.

For example, you can use the `ConversionCharacterExamples` class in Figure C-6 to display a declared integer and `double`. The `main()` method of the class contains three `printf()` statements. The three calls to `printf()` in this class each contain a format string; the first two calls contain a single additional argument, and the last `printf()` statement contains two arguments after the string. None of the format specifiers in this class use any of the optional parameters—only the required percent sign and conversion character. The first `printf()` statement uses `%d` in its format string as a placeholder for the integer argument at the end. The second `printf()` statement uses `%f` as a placeholder for the floating-point argument at the end. The last `printf()` statement uses both a `%d` and `%f` to indicate the positions of the integer and floating-point values at the end, respectively. If you attempt to use a conversion character that is invalid for the data type, the program will compile, but it will throw an exception during execution when it encounters the wrong conversion character for the value being displayed.

```
public class ConversionCharacterExamples
{
    public static void main(String[] args)
    {
        int age = 23;
        double money = 123.45;
        System.out.printf("Age is %d\n", age);
        System.out.printf("Money is $%f\n", money);
        System.out.printf
            ("Age is %d and money is $%f\n", age, money);
    }
}
```

**Figure C-6** The `ConversionCharacterExamples` application

Figure C-7 shows the output of the program, in which the values are inserted in the appropriate places in their strings. Note that floating-point values are displayed with six decimal positions by default.



```
Command Prompt
C:\Java>java ConversionCharacterExamples
Age is 23
Money is $123.450000
Age is 23 and money is $123.450000
C:\Java>
```

**Figure C-7** Output of the `ConversionCharacterExamples` application

Notice that in the `ConversionCharacterExamples` class, the output appears on three separate lines only because the newline character (`\n`) has been included at the end of each `printf()` format string. Unlike the `println()` statement, `printf()` does not include an automatic new line.

## Specifying a Number of Decimal Places to Display with printf()

You can control the number of decimal places displayed when you use a floating-point value in a printf() statement by adding the optional precision factor to the format specifier. Between the percent sign and the conversion character, you can add a decimal point and the number of decimal positions to display. For example, the following statements produce the output “Money is \$123.45”, displaying the money value with just two decimal places instead of six, which would occur without the precision factor:

```
double money = 123.45;  
System.out.printf("Money is $%.2f\n", money);
```

Similarly, the following statements display 8.10. If you use the println() equivalent with amount, only 8.1 is displayed; if you use a printf() statement without inserting the .2 precision factor, 8.100000 is displayed.

```
double amount = 8.1;  
System.out.printf("%.2f", amount);
```

When you use a precision factor on a value that contains more decimal positions than you want to display, the result is rounded. For example, the following statements produce 100.457 (not 100.456), displaying three decimals because of the precision factor.

```
double value = 100.45678;  
System.out.printf("%.3f", value);
```

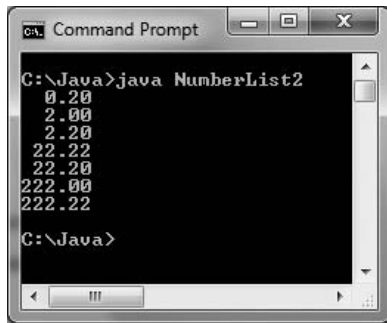
You cannot use the precision factor with an integer value; if you do, your program will throw an `IllegalFormatConversionException`.

## Specifying a Field Size with printf()

You can indicate a field size in which to display output by using an optional integer as the field width. For example, the `NumberList2` class in Figure C-8 displays each array element in a field with a size of 6, using two decimal places. Figure C-9 shows the output of the application. Each value is displayed right-aligned in its field; for example, 0.20 is preceded by two blank spaces, and 22.20 is preceded by one blank space. If a numeric value contains more positions than you indicate for its printf() field size, the field size is ignored, and the entire value is displayed.

```
public class NumberList2  
{  
    public static void main(String[] args)  
    {  
        double[] list = {0.20, 2.00, 2.20, 22.22,  
                        22.20, 222.00, 222.22};  
        int x;  
        for(x = 0; x < list.length; ++x)  
            System.out.printf("%6.2f\n", list[x]);  
    }  
}
```

**Figure C-8** The `NumberList2` class



```
Command Prompt
C:\Java>java NumberList2
0.20
2.00
2.20
22.22
22.20
222.00
222.22
C:\Java>
```

**Figure C-9** Output of the `NumberList2` class

Throughout this book, you have been encouraged to use named constants for numeric values instead of literal constants, so that your programs are clearer. In the program in Figure C-9, you could define constants such as:

```
final int DISPLAY_WIDTH = 6;
final int DISPLAY_DECIMALS = 2;
```

Then the `printf()` statement would be:

```
System.out.printf("%" + DISPLAY_WIDTH + "." +
    DISPLAY_DECIMALS + "f\n", list[x]);
```

Another, perhaps clearer alternative is to define a format string such as the following:

```
final String FORMAT = "%6.2f\n";
```

Then the `printf()` statement would be:

```
System.out.printf(FORMAT, list[x]);
```

You can specify that a value be left-aligned in a field instead of right-aligned by inserting a negative sign in front of the width. Although you can do this with numbers, most often you choose to left-align strings. For example, the following code displays five spaces followed by “hello” and then five spaces followed by “there”. Each string is left-aligned in a field with a size of 10.

```
String string1 = "hello";
String string2 = "there";
System.out.printf("%-10s%-10s", string1, string2);
```

## Using the Optional Argument Index with `printf()`

The **argument index** is an integer that indicates the position of an argument in the argument list of a `printf()` statement. To separate it from other formatting options, the argument index is followed by a dollar sign (`$`). The first argument is referenced by “`1$`”, the second by “`2$`”, and so on.

For example, the `printf()` statement in the following code contains four format specifiers but only two variables in the argument list:

```
int x = 56;
double y = 78.9;
System.out.printf("%1$6d%2$6.2f%1$6d%2$6.2f", x, y);
```

The `printf()` statement displays the value of the first argument, `x`, in a field with a size of 6, and then it displays the second argument, `y`, in a field with a size of 6 with two decimal places. Then, the value of `x` is displayed again, followed by the value of `y`. The output appears as follows:

```
56 78.90    56 78.90
```

## Using the DecimalFormat Class

The **DecimalFormat class** provides ways to easily convert numbers into strings, allowing you to control the display of leading and trailing zeros, prefixes and suffixes, grouping (thousands) separators, and the decimal separator. You specify the formatting properties of `DecimalFormat` with a pattern `String`. The **pattern String** is composed of symbols that determine what the formatted number looks like; it is passed to the `DecimalFormat` class constructor.

The symbols you can use in a pattern `String` include:

- A pound sign ( # ), which represents a digit
- A period ( . ), which represents a decimal point
- A comma ( , ), which represents a thousands separator
- A zero ( 0 ), which represents leading and trailing zeros when it replaces the pound sign



The pound sign is typed using Shift+3 on standard computer keyboards. It also is called an **octothorpe**, a number sign, a hash sign, square, tic-tac-toe, gate, and crunch.

For example, the following lines of code result in `value` being displayed as 12,345,678.90.

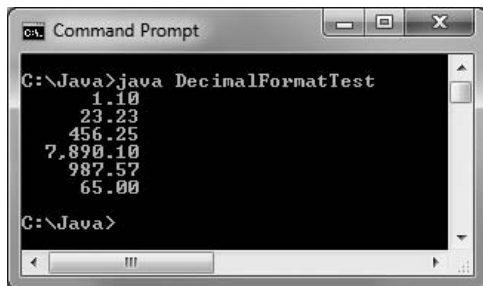
```
double value = 12345678.9;
DecimalFormat aFormat = new DecimalFormat("#,###,###,###.00");
System.out.printf("%s\n", aFormat.format(value));
```

A `DecimalFormat` object is created using the pattern `#,###,###,###.00`. When the object's `format()` method is used in the `printf()` statement, the first two pound signs and the comma between them are not used because `value` is not large enough to require those positions. The value is displayed with commas inserted where needed, and the decimal portion is displayed with a trailing `0` because the `0s` at the end of the pattern indicate that they should be used to fill out the number to two places.

When you use the `DecimalFormat` class, you must use the import statement `import java.text.*`; . Figure C-10 shows a class that creates a `String` pattern that it passes to the `DecimalFormat` constructor to create a `moneyFormat` object. The class displays an array of values, each in a field that is 10 characters wide. Some of the values require commas and some do not. Figure C-11 shows the output.

```
import java.text.*;
public class DecimalFormatTest
{
    public static void main(String[] args)
    {
        String pattern = "###,###.00";
        DecimalFormat moneyFormat = new DecimalFormat(pattern);
        double[] list = {1.1, 23.23, 456.249, 7890.1, 987.5678, 65.0};
        int x;
        for(x = 0; x < list.length; ++x)
            System.out.printf("%10s\n", moneyFormat.format(list[x]));
    }
}
```

Figure C-10 The `DecimalFormatTest` class



```
C:\Java>java DecimalFormatTest
  1.10
 23.23
456.25
7,890.10
987.57
 65.00
C:\Java>
```

Figure C-11 Output of the `DecimalFormatTest` program

## Key Terms

The **`System.out.printf()` method** is used to format numeric values.

A **format string** in a `printf()` statement is a string of characters; it includes optional text (that is displayed literally) and one or more format specifiers.

A **format specifier** in a `printf()` statement is a placeholder for a numeric value.

The **argument index** in a `printf()` statement is an integer that indicates the position of an argument in the argument list.



The **DecimalFormat class** provides ways to easily convert numbers into strings, allowing you to control the display of leading and trailing zeros, prefixes and suffixes, grouping (thousands) separators, and the decimal separator.

A **pattern String** is composed of symbols that determine what a formatted number looks like; it is passed to the DecimalFormat class constructor.

An **octothorpe** is a pound sign.

*This page intentionally left blank*



# Generating Random Numbers

In this appendix, you will:

- ① Understand random numbers generated by computers
- ① Use the `Math.random()` method
- ① Use the `Random` class

## Understanding Random Numbers Generated by Computers

898

A **random number** is one whose value cannot be predicted. Many types of programs use random numbers. For example, simulations that predict phenomena such as urban traffic patterns, crop production, and weather systems typically use random numbers. You might want to use random numbers to change your screen's appearance; for example, screen savers often use random numbers so that a changing pattern remains interesting.

Random numbers are also used in many computer game applications. When you play games with human opponents, their choices are often unpredictable (and sometimes even irrational). Computers usually are predictable and rational, so when you play a game against a computer opponent, you frequently need to generate random numbers. For example, a guessing game would not be very interesting if you were asked to guess the same number every time you played.

Most computer programming languages, including Java, come with built-in methods that generate random numbers. The random numbers are calculated based on a starting value, called a **seed**. The random numbers generated using these methods are not truly random; they are **pseudorandom** in that they produce the same set of numbers whenever the seed is the same. Therefore, if you seed a random-number generator with a constant, you always receive the same sequence of values. Many computer programs use the time of day as a random number-generating seed. For game applications, this method works well, as a player is unlikely to reset his computer's clock and attempt to replay a game beginning at exactly the same moment in time.



For applications in which randomness is more crucial than in game playing, you can use other methods (such as using the points in time at which a radioactive source decays) to generate truly random starting numbers.

There are two approaches to generating random numbers in Java. Both techniques are explained in this appendix and summarized in Table D-1.

Method/Class	Advantages
<code>Math.random()</code> method	You do not need to create an object You do not need to understand constructors and multiple methods
Random class and its methods	You can generate numbers in the format you need without arithmetic manipulation You can create reproducible results if necessary

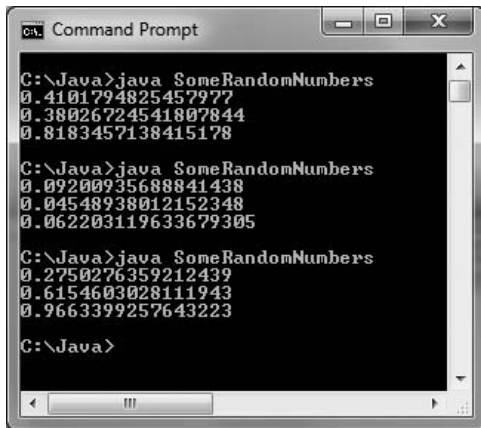
**Table D-1** Generating random numbers in Java

## Using the Math.random() Method

Java's Math class provides a random() method that returns a double value in the range of 0.0 up to, but not including, 1.0. For example, the application in Figure D-1 generates three random numbers and displays them. Figure D-2 shows three successive executions of the program.

```
public class SomeRandomNumbers
{
    public static void main(String[] args)
    {
        double ran;
        ran = Math.random();
        System.out.println(ran);
        ran = Math.random();
        System.out.println(ran);
        ran = Math.random();
        System.out.println(ran);
    }
}
```

Figure D-1 The SomeRandomNumbers class



```
ca: Command Prompt
C:\Java>java SomeRandomNumbers
0.4101794825457977
0.38026724541807844
0.8183457138415178
C:\Java>java SomeRandomNumbers
0.09200935688841438
0.04548938012152348
0.062203119633679305
C:\Java>java SomeRandomNumbers
0.2750276359212439
0.6154603028111943
0.9663399257643223
C:\Java>
```

Figure D-2 Three executions of the SomeRandomNumbers program

The values displayed in Figure D-2 appear to be random, but they are not typical of the values you need in a game-playing program. Usually, you need a relatively small number of whole values. For example, a game that involves a coin flip might only need two values to represent heads or tails, and a dice game might need only six values to represent rolls of a single die. Even in a complicated game in which 40 types of space aliens might attack the player, you need only 40 whole numbers generated to satisfy the program requirements.

For example, suppose you need a random number from 1 to 10. To change any value generated by the `Math.random()` method to fall between 0 and 10, you can multiply the generated number by 10. For example, the last three numbers in Figure D-2 would become approximately 2.75, 6.15, and 9.66. Then, you can eliminate the fractional part of each number by casting it to an `int`; after this step, every generated number will be a value from 0 to 9 inclusive. Finally, you can add 1 to a value so it falls in the range from 1 to 10 instead of 0 to 9. In short, the following statement generates a random number from 1 through 10 inclusive, and assigns it to `ran`:

```
int ran = 1 + (int)(Math.random() * 10);
```

Suppose that, instead of 1 through 10, you need random numbers from 1 through 13. (For example, standard decks of playing cards have 13 values from which you might want to select.) When you use the modulus operator (`%`) to find a remainder, the remainder is always a value from 0 to one less than the number. For example, if you divide any number by 4, the remainder is always a value from 0 through 3. Therefore, to find a number from 1 through 13, you can use a statement like the following:

```
int ranCardValue = ((int)(Math.random() * 100) % 13 + 1);
```

In this statement, a randomly generated value (for example, 0.447) is multiplied by 100 (producing 44.7). The result is converted to an `int` (44). The remainder after dividing by 13 is 5. Finally, 1 is added so the result is 1 through 13 instead of 0 through 12 (giving 6). In short, the general format for assigning a random number to a variable is:

```
int result = ((int)(Math.random() * 100) %  
    HIGHEST_VALUE_WANTED + LOWEST_VALUE_WANTED);
```



Instead of using 100 as the multiplier, you might prefer to use a higher value such as 1000 or 10,000. For most games, the randomness generated using 100 is sufficient.

## Using the Random Class

The `Random` class provides a generator that creates a list of random numbers. To use this class, you must use one of the following import statements:

```
import java.util.*;  
import java.util.Random;
```

You also must instantiate a random-number generator object using one of the following constructors:

- `Random()`, in which the seed comes from the operating system. This constructor sets the seed of the random-number generator to a value that is probably distinct from any other invocation of this constructor.
- `Random(long seed)`, in which you provide a starting seed so that your results are reproducible

After you create a random-number generator object, you can use any of the methods in Table D-2 to get the next random number from the generator.

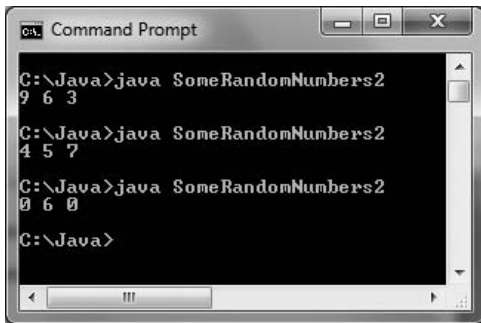
Method	Explanation
<code>nextInt(int n)</code>	Returns a pseudorandom <code>int</code> value between 0 (inclusive) and the specified value <code>n</code> (exclusive), drawn from the random-number generator's sequence
<code>nextInt()</code>	Returns a pseudorandom <code>int</code> value between 0 (inclusive) and 1.0 (exclusive), drawn from the random-number generator's sequence
<code>nextLong()</code>	Returns the next pseudorandom <code>Long</code> value from the generator's sequence
<code>nextFloat()</code>	Returns the next pseudorandom <code>float</code> value between 0.0 and 1.0 from the generator's sequence
<code>nextDouble()</code>	Returns the next pseudorandom <code>double</code> value between 0.0 and 1.0 from the generator's sequence
<code>nextBoolean()</code>	Returns the next pseudorandom <code>boolean</code> value from the generator's sequence

**Table D-2** Selected Random class methods

For example, Figure D-3 contains an application that declares a `Random` generator named `ran`, using the version of the constructor that takes no arguments. This ensures that the results are different each time the application runs. The program then defines `LIMIT` as 10, and calls `ran.nextInt(LIMIT)` three times, displaying the results (see Figure D-4).

```
import java.util.*;
public class SomeRandomNumbers2
{
    public static void main(String[] args)
    {
        Random ran = new Random();
        final int LIMIT = 10;
        System.out.print(ran.nextInt(LIMIT) + " ");
        System.out.print(ran.nextInt(LIMIT) + " ");
        System.out.println(ran.nextInt(LIMIT));
    }
}
```

**Figure D-3** The `SomeRandomNumbers2` class



```
Command Prompt
C:\Java>java SomeRandomNumbers2
9 6 3
C:\Java>java SomeRandomNumbers2
4 5 7
C:\Java>java SomeRandomNumbers2
0 6 0
C:\Java>
```

**Figure D-4** Three executions of the `SomeRandomNumbers2` program

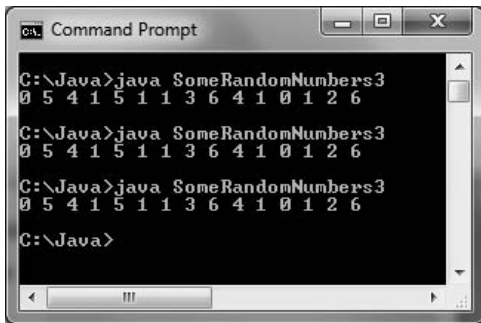
In Figure D-4, each displayed value falls between 0 and `LIMIT`. (Of course, to select values between 1 and `LIMIT` inclusive, you could add 1 to each result.)

Figure D-5 shows a class using the version of the `Random` constructor that takes an argument (shaded). In this example, a value between 0 and 6 inclusive is generated 15 times. Figure D-6 shows the output when the program is run three times. Although the 15 numbers displayed for each execution constitute a random list, the list is identical in each program execution. You use a seed when you want random but reproducible results. For games, you usually want to use the no-argument version of the `Random` constructor.

```
import java.util.*;
public class SomeRandomNumbers3
{
    public static void main(String[] args)
    {
        Random ran = new Random(129867L);
        final int TIMES = 15;
        final int LIMIT = 7;
        for(int x = 0; x < TIMES; ++x)
            System.out.print(ran.nextInt(LIMIT) + " ");
        System.out.println();
    }
}
```

**Figure D-5** The `SomeRandomNumbers3` class





```
C:\Java>java SomeRandomNumbers3
0 5 4 1 5 1 1 3 6 4 1 0 1 2 6

C:\Java>java SomeRandomNumbers3
0 5 4 1 5 1 1 3 6 4 1 0 1 2 6

C:\Java>java SomeRandomNumbers3
0 5 4 1 5 1 1 3 6 4 1 0 1 2 6

C:\Java>
```

**Figure D-6** Three executions of the `SomeRandomNumbers3` program

## Key Terms

A **random number** is one whose value cannot be predicted.

A **seed** is a starting value.

**Pseudorandom** numbers appear to be random, but are the same set of numbers whenever the seed is the same.

*This page intentionally left blank*

# Javadoc

In this appendix, you will:

- ③ Learn about the Javadoc documentation generator
- ③ Understand Javadoc comment types
- ③ Generate Javadoc documentation

## The Javadoc Documentation Generator

**Javadoc** is a documentation generator created by Sun Microsystems that allows you to generate Application Programming Interface (API) documentation in Hypertext Markup Language (HTML) format from Java source code. In Chapter 1, you learned that you can place both line and block comments anywhere in a program to provide documentation that can be useful both to yourself and others. A **Javadoc comment** is a special form of block comment that provides a standard way to document Java code. After you write Javadoc comments, they can be interpreted by special utility programs that generate an HTML document. The resulting HTML document provides an attractive format for the documentation when you open it in a browser. Most class libraries, both commercial and open source, provide Javadoc documents. If you have visited the Sun Microsystems Web site to research how to use a class, you most likely have viewed documentation created by the Javadoc utility.

In Chapter 1, you learned that block comments start with `/*` and end with `*/` and can span as many lines as necessary, and that Javadoc comments start with `/**` and end with `*/`. For symmetry, many developers end their Javadoc comments with `**/`. By convention, asterisks start intermediate lines in a Javadoc comment. This is not required, but it helps you more easily distinguish comments from code.

Javadoc comments can contain tags. A **Javadoc tag** is a keyword within a comment that the Javadoc tool can process. Tags begin with an at-sign ( `@` ) and use a limited vocabulary of keywords. Some commonly used Javadoc tags include:

- `@author`: Describes the author of a document
- `@param`: Describes a parameter of a method or constructor
- `@return`: Describes the return type of a method
- `@throws`: Describes an exception a method may throw
- `@exception`: Describes an exception

## Javadoc Comment Types

There are two types of Javadoc comments:

- Class-level comments that provide a description of a class
- Member-level comments that describe the purposes of class members

**Class-level Javadoc comments** provide a description of a class; you place class-level comments above the code that declares a class. Class-level comments frequently contain author tags and a description of the class. Figure E-1 shows a shaded class-level comment in a class.

```
/**
 * @author Joyce Farrell.
 * The Employee class contains data about one employee.
 * Fields include an ID number and an hourly pay rate.
 */
public class Employee
{
    private int idNum;
    private double hourlyPay;
    public Employee(int id, double pay)
    {
        idNum = id;
        hourlyPay = pay;
    }
    int getIdNum()
    {
        return idNum;
    }
    void setIdNum(int id)
    {
        idNum = id;
    }
}
```

**Figure E-1** An Employee class with class-level comments

**Member-level Javadoc comments** describe the fields, methods, and constructors of a class. Method and constructor comments may contain tags that describe the parameters, and method comments may also contain return tags. Figure E-2 shows a class with some shaded member-level comments.

```
/**
 * @author Joyce Farrell.
 * The Employee2 class contains data about one employee.
 * Fields include an ID number and an hourly pay rate.
 */
public class Employee2
{
    /**
     * Employee ID number
     */
    private int idNum;
    /**
     * Employee hourly pay
     */
    private double hourlyPay;
    /**
     * Sole constructor for Employee2
     */
}
```

**Figure E-2** An Employee2 class with class-level and member-level comments (continues)

(continued)

```
public Employee2(int id, double pay)
{
    idNum = id;
    hourlyPay = pay;
}
/**
 * Returns the Employee2 ID number
 *
 * @return int
 */
int getIdNum()
{
    return idNum;
}
/**
 * Sets the Employee2 ID number
 *
 * @param id employee ID number
 */
void setIdNum(int id)
{
    idNum = id;
}
}
```

**Figure E-2** An Employee2 class with class-level and member-level comments

Like all program comments, Javadoc comments *can* contain anything. However, you should follow the conventions for Javadoc comments. For example, developers expect all Javadoc comments to begin with an uppercase letter, and they recommend that method comments start with a verb such as “Returns” or “Sets.” For more information, go to the Java Web site.

## Generating Javadoc Documentation

To generate the Javadoc documentation from your class, you should do the following:

1. Create a folder in which to store your class. For example, you might store the Employee2.java file in a folder named Employee2.
2. Within the folder, you can create a Documents subfolder to hold the documentation that you generate. However, if you omit this step and use the syntax described in Step 3, the folder is created for you automatically.
3. Go to the command prompt and navigate to the directory that holds the Employee2.java file. (See Appendix A for information on finding the command

prompt and changing directories.) From the command prompt, run the following command:

```
javadoc -d Documents *.java
```

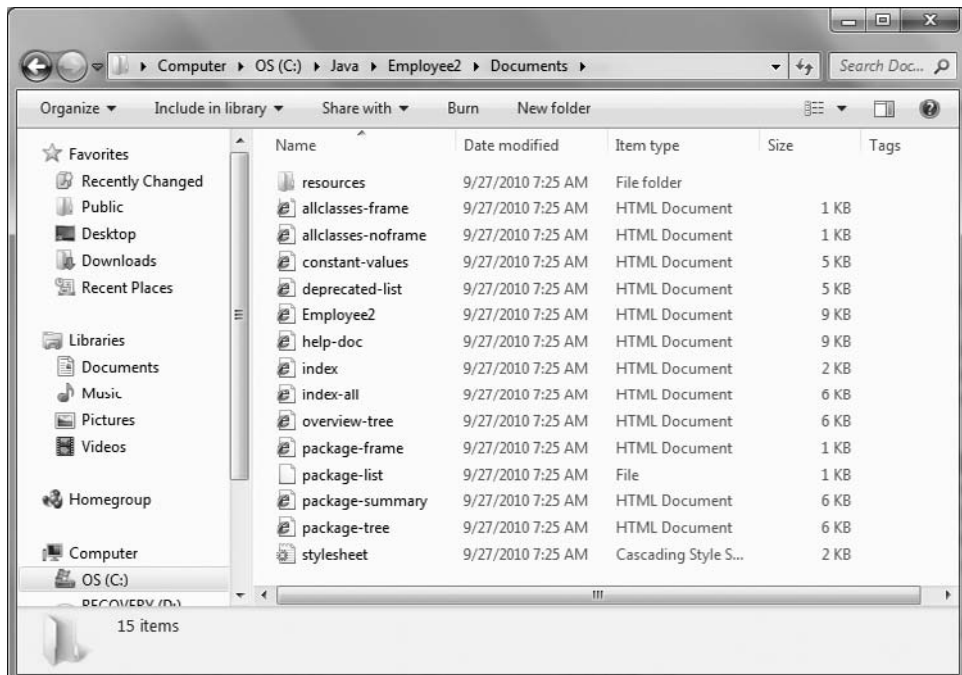
The `-d` is the directory option. If you omit it, all the generated files are saved in the current directory. By including this option, you indicate that the files should be saved in the Documents directory.



To see the author's name in the resulting documentation, change the Javadoc command to the following:  
`javadoc -d Documents -author *.java`

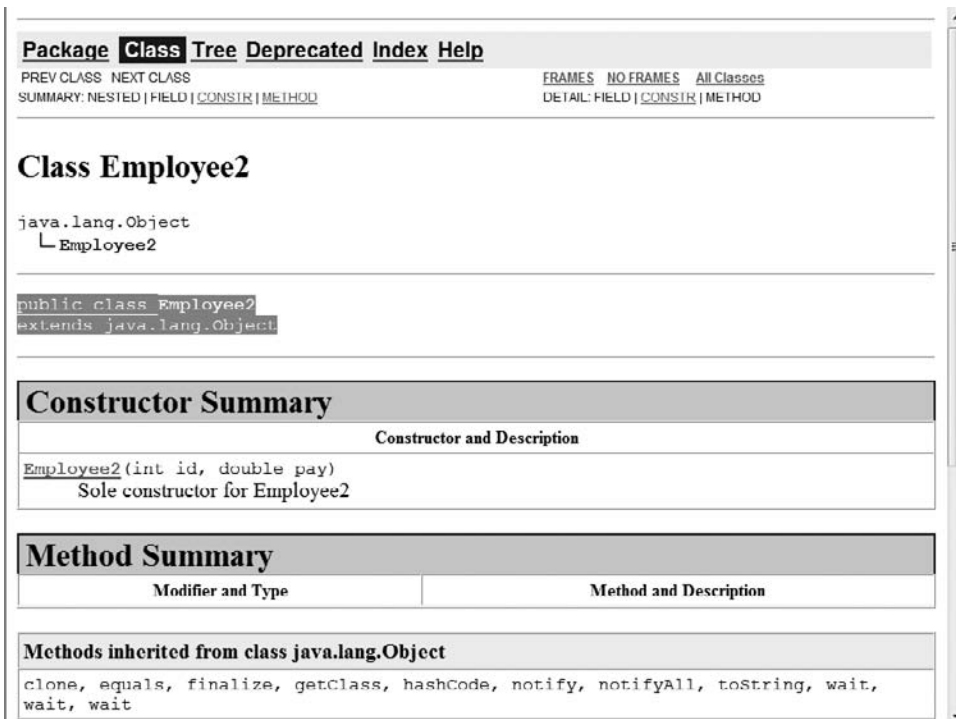
If you are using the jGRASP development environment to create your Java programs, you can execute the Javadoc command with a button click. You can download the jGRASP program from <http://jGRASP.org>.

4. Navigate to the Documents folder. You will see a number of generated files, as shown in Figure E-3. The list includes HTML documents with information about all the constants in your class, all the deprecated methods in your class, and so on. (The `Employee2` class has no constants or deprecated methods, but you can open the files and view the format that the contents would take if they existed.)



**Figure E-3** Contents of the Employee2 Documents folder in Internet Explorer

The index.html file provides an index of all class interface, constructor, field, and method names; when you double-click it, the file opens in your default browser. Figure E-4 shows how the first part of the index.html file for `Employee2` appears in Internet Explorer. If you have searched the Java Web site for documentation, the format of the page in Figure E-4 is familiar to you. The class name and other information appear in a font and style consistent with other classes in the Java API. You can see information about the class constructor and the notes that you added in your comments. You see inheritance information—`Employee2` descends directly from `Object`. The format of this documentation is familiar to users, making it much easier for them to find what they need than if each developer created documentation formats independently.



The screenshot shows the Javadoc documentation for the `Employee2` class. At the top, there are navigation links: **Package**, **Class** (selected), **Tree**, **Deprecated**, **Index**, and **Help**. Below these are links for `PREV CLASS`, `NEXT CLASS`, `FRAMES`, `NO FRAMES`, and `All Classes`. There are also links for `SUMMARY: NESTED | FIELD | CONSTR | METHOD` and `DETAIL: FIELD | CONSTR | METHOD`.

The main heading is **Class Employee2**. Below it, the inheritance is shown as `java.lang.Object` with a downward arrow pointing to `Employee2`.

The class declaration is shown as `public class Employee2 extends java.lang.Object;`.

The **Constructor Summary** section has a sub-heading **Constructor and Description**. It lists the constructor `Employee2(int id, double pay)` with the description "Sole constructor for Employee2".

The **Method Summary** section has two sub-headings: **Modifier and Type** and **Method and Description**.

The **Methods inherited from class java.lang.Object** section lists the methods: `clone`, `equals`, `finalize`, `getClass`, `hashCode`, `notify`, `notifyAll`, `toString`, `wait`, and `wait`.

**Figure E-4** The `Employee2` class documentation in Internet Explorer



The Javadoc tool will run on .java source files that are stub files with no method bodies. This means you can write documentation comments and run the Javadoc tool when you are first designing classes, before you have written implementations for the class's methods.

Writing acceptable Javadoc comments requires adherence to some style standards. For example, professionals recommend that multiple `@author` tags should be listed in chronological order, with the creator of the class listed at the top, and that multiple `@param`



tags should be listed in argument-declaration order. Additionally, Javadoc comments can provide hyperlinks that allow navigation from one document to another. For example, when a class contains a field that is an object of another class, you might want to link to the other class's documentation. For more information, see the recommendations at <http://www.oracle.com/technetwork/java/javase/documentation/index-137868.html>.

## Specifying Visibility of Javadoc Documentation

By default, Javadoc documents only `public` and `protected` members of an API. In other words, even if you write Javadoc comments for `private` members, the comments do not appear in the generated documentation unless you take special action to make them visible. Although the `index.html` file contains details about the `Employee2` class's constructor and methods, there is no information about the `private` fields `idNum` and `hourlyPay`. To generate that documentation, you must specify `private` visibility by using the following javadoc command:

```
javadoc -d Documents -private *.java
```

Figure E-5 shows the documentation generated by this command. You can see that the newly generated documentation includes a Field Summary section. It lists the fields in alphabetical order preceded by their access specifiers and data types. Each field identifier is followed by the appropriate description that was provided in the Javadoc comment in the source code.

The screenshot shows the Javadoc documentation for the `Employee2` class. At the top, there are navigation links: [Package](#), [Class](#), [Tree](#), [Deprecated](#), [Index](#), and [Help](#). Below these are links for [PREV CLASS](#), [NEXT CLASS](#), [FRAMES](#), [NO FRAMES](#), and [All Classes](#). There are also links for [SUMMARY: NESTED | FIELD | CONSTR | METHOD](#) and [DETAIL: FIELD | CONSTR | METHOD](#).

The main heading is **Class Employee2**. Below it, the class hierarchy is shown: `java.lang.Object` is the superclass, and `Employee2` is the subclass.

The source code snippet is:

```
public class Employee2
extends java.lang.Object
```

The **Field Summary** section is a table with two columns: **Modifier and Type** and **Field and Description**.

Modifier and Type	Field and Description
private double	<a href="#">hourlyPay</a> Employee hourly pay
private int	<a href="#">idNum</a> Employee ID number

The **Constructor Summary** section is a table with two columns: **Constructor and Description**.

Constructor and Description
<a href="#">Employee2(int id, double pay)</a> Sole constructor for Employee2

**Figure E-5** The `Employee2` class documentation when `private` members are included

You can specify four types of visibility:

- `public`—Displays `public` members only
- `protected`—Displays `public` and `protected` members only. This is the default option.
- `package`—Displays package classes and members in addition to `public` and `protected` members
- `private`—Displays all members

---

## Key Terms

**Javadoc** is a documentation generator created by Sun Microsystems that allows you to generate Application Programming Interface (API) documentation in Hypertext Markup Language (HTML) format from Java source code.

A **Javadoc comment** is a special form of block comment that provides a standard way to document Java code.

A **Javadoc tag** is a keyword within a comment that the Javadoc tool can process.

**Class-level Javadoc comments** provide a description of a class; you place class-level comments above the code that declares a class.

**Member-level Javadoc comments** describe the fields, methods, and constructors of a class.

# Glossary

## A

**absolute path**—a complete file path that does not require any other information to locate a file on a system.

**abstract class**—a class from which you cannot create any concrete objects, but from which you can inherit. Abstract classes usually have one or more empty abstract methods. Contrast with *concrete classes*.

**abstract data type**—a type whose implementation is hidden and accessed through its public methods.

**abstract method**—a method declared with the keyword `abstract`; it is a method with no body that must be implemented in a subclass.

**abstraction**—the programming feature that allows you to use a method name to encapsulate a series of statements.

**accelerator**—a key combination that causes a menu item to be chosen, whether or not the menu item is visible.

**access modifier**—an access specifier.

**access specifier**—defines the circumstances under which a class can be accessed and the other classes that have the right to use a class.

**accessor methods**—methods that return information about an object.

**accumulating**—the process of repeatedly increasing a value by some amount to produce a total.

**action key**—a keyboard key that does not generate a character.

**actionPerformed(ActionEvent e) method**—a method that defines the actions that occur in response to an event.

**actual parameters**—the arguments in a method call. Contrast with *formal parameters*.

**acyclic gradient**—a fill pattern in which a color shift occurs once between two points.

**adapter class**—a class that implements all the methods in an interface, providing an empty body for each method.

**add and assign operator**—an operator that alters the value of the operand on the left by adding the operand on the right to it; it is composed of a plus sign and an equal sign ( `+=` ).

**add() method**—a method that adds components to a container.

**addActionListener() method**—a method that tells a class to expect ActionEvents.

**addPoint() method**—a method that adds points to a Polygon object.

**ad-hoc polymorphism**—polymorphism that occurs when a single method

name can be used with a variety of data types because various implementations exist; it is another name for method overloading.

**aggregation**—a type of composition in which a class contains one or more members of another class that would continue to exist without the object that contains them.

**Allman style**—the indent style in which curly braces are aligned and each occupies its own line; it is named for Eric Allman, a programmer who popularized the style. Contrast with *K & R style*.

**ambiguous**—describes a situation in which the compiler cannot determine which method to use.

**anonymous classes**—nested, local classes that have no identifier.

**anonymous object**—an unnamed object.

**append() method**—a `StringBuilder` class method that lets you add characters to the end of a `StringBuilder` object.

**applet**—a Java program that is called from within another application, frequently a Web page.

**Applet Viewer**—a program that comes with the JDK that allows you to view applets without using a Web browser.

**appletviewer command**—a command that allows you to view an applet in a viewing program that comes with the JDK.

**application**—a stand-alone, executable program.

**application files**—files that store software instructions. See also *program files*.

**application-triggered painting**—painting operations that occur when the internal state of a component has changed. Contrast with *system-triggered painting*.

**arc**—a portion of a circle.

**architecturally neutral**—describes the feature of Java that allows a program to run on any platform.

**argument index**—in a `printf()` statement, an integer that indicates the position of an argument in the argument list.

**arguments**—data items sent to methods in a method call.

**arithmetic operators**—operators used to perform calculations with values.

**array**—a named list of data items that all have the same type.

**ArrayList class**—a Java class that provides a dynamically resizable container that stores lists of objects.

**Arrays class**—a built-in Java class that contains many useful methods for manipulating arrays, such as methods to search, fill, compare, and sort arrays.

**ascending**—describes the order from lowest value to highest.

**ascent**—one of three measures of a `Font`'s height; it is the height of an uppercase character from a baseline to the top of the character. See also *leading* and *descent*.

**ASCII**—an acronym for American Standard Code for Information Interchange, a character set widely used to represent computer data.

**assert statement**—a statement that creates an assertion.

**assertion**—a Java language feature that can help you detect logic errors and debug a program.

**assignment**—the act of providing a value for a variable.

**assignment operator**—the equal sign (`=`); any value to the right of the equal sign is

assigned to the variable on the left of the equal sign.

**associativity**—describes the order in which operands are used with operators.

**at run time**—describes the period of time during which a program executes.

**attributes**—the characteristics that define an object as part of a class.

## B

**back buffer**—the offscreen image during double buffering.

**base class**—a class that is used as a basis for inheritance.

**BasicStroke**—a class that defines line types and implements the `Stroke` interface.

**batch processing**—processing that involves performing the same tasks with many records, one after the other.

**binary files**—files that contain data that has not been encoded as text; their contents are in binary format.

**binary numbering system**—a numbering system based on two digits, 0 and 1, in which each column represents a value two times higher than the column to its right.

**binary operators**—operators that require two operands.

**bit**—a binary digit, 0 or 1, used to represent computerized values.

**black box**—a device you can use without understanding how it works.

**blank final**—a `final` variable that has not yet been assigned a value.

**block**—the code between a pair of curly braces.

**block comments**—comments that start with a forward slash and an asterisk ( `/*` )

and end with an asterisk and a forward slash ( `*/` ). Block comments can appear on a line by themselves, on a line before executable code, or on a line after executable code. Block comments also can extend across as many lines as needed. Contrast with *line comments*.

**block line transfer** or **blitting**—the act of copying contents from one surface to another.

**Boolean values**—true or false values; every computer decision results in a Boolean value.

**Boolean variable**—a variable of the data type that can hold only one of two values—true or false.

**BorderLayout manager**—the default manager class for all content panes. When you use the `BorderLayout` manager, the components fill the screen in five regions: north, south, east, west, and center.

**BoxLayout manager**—a layout manager that allows multiple components to be laid out either vertically or horizontally. The components do not wrap, so a vertical arrangement of components, for example, stays vertically arranged when the frame is resized.

**bubble sort**—a type of sort in which you continue to compare pairs of items, swapping them if they are out of order, so that the smallest items “bubble” to the top of the list, eventually creating a sorted list.

**buffer**—a memory location that you use to hold data temporarily.

**ButtonGroup**—a UI component that groups several components, such as `JCheckBoxes`, so a user can select only one at a time.

**byte**—the data type that holds very small integers, from `-128` to `127`.

**bytecode**—programming statements that have been compiled into binary format.

## C

**call**—to invoke a method.

**call stack**—the memory location where the computer stores the list of method locations to which the system must return.

**called method**—a term used to describe the relationship between two methods; a method that is invoked by another.

**calling method**—a term used to describe the relationship between two methods; a method that invokes another.

**camel casing**—a naming style in which an identifier begins with a lowercase letter and subsequent words within the identifier are capitalized. Contrast with *Pascal casing*.

**capacity**—an attribute of an `ArrayList` whose value is the number of items it can hold without having to increase its size. Also, with a `StringBuilder` object, the actual length of the buffer, as opposed to that of the string contained in the buffer.

**capacity() method**—a `StringBuilder` class method that returns the actual length, or capacity, of the `StringBuilder` object.

**CardLayout manager**—a layout manager that generates a stack of containers or components, one on top of another.

**cast operator**—an operator that performs an explicit type conversion; it is created by placing the desired result type in parentheses before the expression to be converted.

**catch block**—a segment of code that can handle an exception that might be thrown by the `try` block that precedes it.

**catch or specify requirement**—the Java rule that checked exceptions require catching or declaration.

**char**—the data type that holds any single character.

**character**—any letter, number, or special symbol (such as a punctuation mark) that comprises data.

**Character class**—a class whose instances can hold a single character value. This class also defines methods that can manipulate or inspect single-character data.

**charAt() method**—a `String` and `StringBuilder` class method that requires an integer argument that indicates the position of the character that the method returns.

**checked exceptions**—exceptions that a programmer should plan for and from which a program should be able to recover. Contrast with *unchecked exceptions*.

**child class**—a derived class.

**class**—a group or collection of objects with common properties.

**class body**—the set of data items and methods between the curly braces that follow the class header.

**class client**—an application or class that instantiates objects of another class. See also *class user*.

**class definition**—a description of attributes and methods of objects instantiated from a class.

**class diagram**—a visual tool that provides an overview of a class. It consists of a rectangle divided into three sections—the top section contains the name of the class, the middle section contains the names and data types of the attributes, and the bottom section contains the methods.

**class library**—a package.

**class methods**—static methods that do not have a `this` reference (because they have no object associated with them).

**class user**—an application or class that instantiates objects of another prewritten class. See also *class client*.

**class variables**—static variables that are shared by every instantiation of a class.

**class-level Javadoc comments**—Javadoc comments that provide a description of a class; you place class-level comments above the code that declares a class.

**clean build**—a compilation that is created when you delete all previously compiled versions of a class before compiling again.

**clearRect() method**—a method that draws a rectangle using the background color to create what appears to be an empty or “clear” rectangle.

**client method**—a method that calls another method.

**closing a file**—the action that makes a file no longer available to an application.

**collision**—describes a class naming conflict.

**Color class**—a class that defines colors for you to use in your applications.

**comes into scope**—describes what happens to a variable when it is declared. Contrast with *goes out of scope*.

**comma-separated values (CSV)**—fields that are separated with a comma.

**commands**—program statements.

**comment out**—the technique of turning a program statement into a comment so the compiler will not execute its command.

**compareTo() method**—a `String` class method used to compare two `Strings`; the

method returns zero only if the two `Strings` refer to the same value. If there is any difference between the `Strings`, a negative number is returned if the calling object is “less than” the argument, and a positive number is returned if the calling object is “more than” the argument.

**comparison operator**—a relational operator.

**compiler**—a program that translates language statements into machine code. A compiler translates an entire program before executing it. Contrast with *interpreter*.

**compile-time error**—an error for which the compiler detects a violation of language syntax rules and is unable to translate the source code to machine code.

**composition**—describes the relationship between classes when an object of one class is a data field within another class. See also *has-a relationship*.

**computer file**—a collection of stored information in a computer system.

**computer simulations**—programs that attempt to mimic real-world activities so that their processes can be improved or so that users can better understand how the real-world processes operate.

**concatenated**—describes values that are added onto the end of another value.

**concatenation**—the process of joining a variable to a string to create a longer string.

**concrete class**—a nonabstract class from which objects can be instantiated. Contrast with *abstract class*.

**conditional operator**—an operator that requires three expressions separated with a question mark and a colon; the operator is used as an abbreviated version of the `if...else` structure.

**conditional OR operator**—an operator used between Boolean expressions to determine whether either expression is true. The OR operator is written as two pipes ( `||` ).

**confirm dialog box**—displays the options Yes, No, and Cancel; you can create one using the `showConfirmDialog()` method in the `JOptionPane` class.

**console applications**—programs that support character output to a computer screen in a DOS window.

**constant**—describes values that cannot be changed during the execution of an application.

**constructor**—a method that establishes an object.

**consume**—to retrieve and discard an entry without using it.

**container**—a type of component that holds other components so you can treat a group of them as a single entity.

**containment hierarchy**—a tree of components that has a top-level container as its root (that is, at its uppermost level).

**content pane**—a component that contains all the visible components in a top-level container's user interface.

**copyArea() method**—a method that copies any rectangular area to a new location.

**counter-controlled loop**—a definite loop. Contrast with *event-controlled loop*.

**counting**—the process of continually incrementing a variable to keep track of the number of occurrences of some event.

**cyclic gradient**—a fill pattern in which a shift between colors occurs repeatedly between two points.

## D

**data files**—files that consist of related records that contain facts and figures, such as employee numbers, names, and salaries.

**data type**—describes the type of data that can be stored in a variable, how much memory the item occupies, and what types of operations can be performed on the data.

**dead code**—unreachable statements.

**debugging**—the process of locating and repairing a program's error.

**decimal numbering system**—the numbering system based on 10 digits, 0 through 9, in which each column value is 10 times the value of the column to its right.

**DecimalFormat class**—a class that provides ways to easily convert numbers into strings, allowing you to control the display of leading and trailing zeros, prefixes and suffixes, grouping (thousands) separators, and the decimal separator.

**decision structure**—a logical structure that involves choosing between alternative courses of action based on some value within a program.

**decrementing**—the act of subtracting 1 from a variable.

**default constructor**—a constructor that requires no arguments.

**default package**—the unnamed package in which a class is placed if you do not specify a package for the class.

**definite loop**—a loop that executes a specific number of times; a counted loop. Contrast with *indefinite loop*.

**derived class**—a class that inherits from a base class.



**descending**—describes the order from highest to lowest.

**descent**—one of three measures of a Font’s height; it measures the part of characters that “hang below” the baseline, such as the tails on the lowercase letters g and j. See also *ascent* and *leading*.

**destroy() method**—a method invoked in an applet when the user closes the browser or Applet Viewer.

**dialog box**—a GUI object resembling a window in which you can place messages you want to display.

**direct access files**—random access files.

**directories**—elements in a storage organization hierarchy. See also *folders*.

**divide and assign operator**—an operator that alters the value of the operand on the left by dividing the operand on the right into it; it is composed of a slash and an equal sign ( /= ).

**do-nothing loop**—a loop that performs no actions other than looping.

**do...while loop**—a loop that executes a loop body at least one time; it checks the loop control variable at the bottom of the loop after one repetition has occurred.

**double**—a data type that can hold a floating-point value of up to 14 or 15 significant digits of accuracy. Contrast with *float*.

**double buffering**—the default buffering strategy in which JPanels are drawn offscreen when they are updated and displayed only when complete.

**Double class**—a wrapper class that contains a simple double and useful methods to manipulate it.

**double-precision floating-point number**—a type of value that is stored in a double.

**draw3DRect() method**—a method that draws a rectangle that appears to have “shadowing” on two of its edges—the effect is that of a rectangle that is lit from the upper-left corner and slightly raised or slightly lowered.

**drawArc() method**—a method that draws an arc.

**drawLine() method**—a method that draws a straight line between two points on the screen.

**drawOval() method**—a method that draws an oval.

**drawPolygon() method**—a method that draws complex shapes.

**drawRect() method**—a method that draws the outline of a rectangle.

**drawRoundRect() method**—a method that draws rectangles with rounded corners.

**drawString() method**—a method that allows you to draw a String in a JFrame or other component.

**dual-alternative if**—a decision structure that takes one of two possible courses of action. Contrast with *single-alternative if*.

**dummy values**—values the user enters that are not “real” data, but just signals to stop data entry.

**dynamic method binding**—the ability of an application to select the correct subclass method when the program executes. See also *late binding*.

**dynamically resizable**—describes an object whose size can change during program execution.

## E

**echoing input**—the act of repeating the user’s entry as output so the user can visually confirm the entry’s accuracy.

**editable**—describes a component that can accept keystrokes.

**element**—one variable or object in an array.

**empty body**—a block with no statements in it.

**empty statement**—a statement that contains only a semicolon.

**encapsulation**—the act of hiding data and methods within an object.

**endcap styles**—styles applied to the ends of lines that do not join with other lines; they include `CAP_BUTT`, `CAP_ROUND`, and `CAP_SQUARE`.

**endsWith() method**—a `String` class method that takes a `String` argument and returns `true` or `false` if a `String` object does or does not end with the specified argument.

**enhanced for loop**—a language construct that allows you to cycle through an array without specifying the starting and ending points for the loop control variable.

**enum constants**—the allowed values for an enumerated data type.

**enumerated data type**—a programmer-created data type with a fixed set of values.

**equals() method**—an `Object` class method that takes a single argument, which must be the same type as the type of the invoking object, and returns a `Boolean` value indicating whether two object references are equal. The method is overridden in the `String` class to evaluate the contents of two `String` objects to determine if they are equivalent.

**equalsIgnoreCase() method**—a `String` class method that ignores case when determining if two `Strings` are equivalent.

**equivalency operator**—the operator composed of two equal signs that compares values and returns `true` if they are equal.

**Error class**—a class that represents more serious errors than the `Exception` class—those from which a program usually cannot recover.

**escape sequence**—a sequence that begins with a backslash followed by a character; the pair frequently represents a nonprinting character.

**event**—a result when a user takes action on a component.

**event-controlled loop**—an indefinite loop. Contrast with *counter-controlled loop*.

**event-driven program**—a program in which the user might initiate any number of events in any order.

**event handler**—a method that executes because it is called automatically when an appropriate event occurs.

**exception**—in object-oriented terminology, an unexpected or error condition.

**Exception class**—a class that comprises less serious errors than those from the `Error` class; the `Exception` class represents unusual conditions that arise while a program is running, and from which the program can recover.

**exception handling**—an object-oriented technique for managing errors.

**exception specification**—the practice of using the keyword `throws` followed by an `Exception` type in the method header. If a method throws a checked `Exception` that it will not catch but that will be caught by a different method, you must use an exception specification.

**executing**—the act of carrying out a program statement or program.

**explicit conversion**—the data type transformation caused by using a cast operator.

**extended**—describes classes that have descended from another class.

**extends**—a keyword used to achieve inheritance in Java.

**Extensible Hypertext Markup Language (XHTML)**—an extension of HTML.

## F

**factory methods**—methods that assist in object creation.

**FAQs**—frequently asked questions.

**fault-tolerant**—describes applications that are designed so that they continue to operate, possibly at a reduced level, when some part of the system fails.

**field**—a data variable declared in a class outside of any method. In reference to storage, a group of characters that has some meaning.

**file channel**—an object that is an avenue for reading and writing a file.

**fill patterns**—patterns that describe how drawing objects are filled in.

**fill3DRect() method**—a method that creates filled, three-dimensional rectangles.

**fillArc() method**—a method that creates a solid arc.

**fillOval() method**—a method that draws a solid, filled oval.

**fillPolygon() method**—a method that draws a solid shape.

**fillRect() method**—a method that draws a solid, or filled, rectangle.

**final**—the keyword that precedes named constants, describes superclass methods

that cannot be overridden in a subclass, and describes classes in which all methods are final.

**finally block**—a block of code that executes at the end of a try...catch sequence.

**fixed method binding**—the opposite of dynamic method binding; it occurs when a subclass method is selected while the program compiles rather than while it is running. See also *static method binding*.

**float**—a data type that can hold a floating-point value of up to six or seven significant digits of accuracy. Contrast with *double*.

**floating-point**—describes a number that contains decimal positions.

**floating-point division**—the operation in which two values are divided and either or both are floating-point values.

**flowchart**—a tool that helps programmers plan a program's logic by writing the steps in diagram form, as a series of shapes connected by arrows.

**FlowLayout manager**—a layout manager that arranges components in rows across the width of a `Container`; when the current row is filled, additional `Components` are placed in new rows. By default, the components in each row are centered.

**flushing**—an operation to clear bytes that have been sent to a buffer for output but that have not yet been output to a hardware device.

**folders**—elements in a storage organization hierarchy. See also *directories*.

**Font class**—a Java class that holds typeface and size information.

**for loop**—a loop that can be used when a definite number of loop iterations is required.

**foreach**—the enhanced for loop.

**formal parameters**—the variables in a method declaration that accept the values from actual parameters. Contrast with *actual parameters*.

**format specifier**—in a `printf()` statement, a placeholder for a numeric value.

**format string**—in a `printf()` statement, a string of characters that includes optional text (that is displayed literally) and one or more format specifiers.

**fragile**—describes classes that are prone to errors.

**fully qualified identifier**—describes a filename that includes the entire hierarchy in which a class is stored.

**fundamental classes**—basic classes contained in the `java.lang` package that are automatically imported into every program you write. Contrast with *optional classes*.

## G

**garbage value**—the unknown value stored in an uninitialized variable.

**getAvailableFontFamilyNames() method**—a method that returns the fonts that are available on your system.

**getContentPane() method**—a method that returns a reference to a container's content pane.

**getDefaultToolkit() method**—a method that provides information about the system in use.

**getFontMetrics() method**—a method that returns a `FontMetrics` object so you can discover its leading, ascent, descent, and height.

**getScreenResolution() method**—a method that returns the screen resolution on the current system.

**getScreenSize() method**—a method that returns the screen size as a `Dimension` object.

**getText() method**—a method that retrieves the `String` of text in a `Component`.

**glass pane**—a pane that resides above the content pane in a container. It can contain tool tips.

**goes out of scope**—describes what happens to a variable at the end of the block in which it is declared. Contrast with *comes into scope*.

**gradient fill**—a gradual shift from one color at one coordinate point to a different color at a second coordinate point.

**graphical user interfaces (GUIs)**—environments that allow users to interact with a program in a graphical environment.

**Graphics class**—an abstract class that descends directly from `Object` and holds data about graphics operations and methods for drawing shapes, text, and images.

**Graphics2D class**—a class that provides tools for two-dimensional drawing.

**GridBagLayout manager**—a layout manager that allows you to add `Components` to precise locations within the grid, as well as to indicate that specific `Components` should span multiple rows or columns within the grid.

**GridLayout manager**—a layout manager that divides a container surface into a grid.

## H

**has-a relationship**—a relationship based on composition.

**hash code**—a calculated number used to identify an object.

**header**—the first line of a method; its declaration.

**heavyweight components**—components that require interaction with the local operating system. Contrast with *lightweight components*.

**height of a font**—the sum of its leading, ascent, and descent.

**hexadecimal numbering system**—a numbering system based on 16 digits, 0 through F, in which each column represents a value 16 times higher than the column to its right.

**high-level programming language**—a language that allows you to use a vocabulary of reasonable terms, such as “read,” “write,” or “add,” instead of the sequences of on and off switches that perform these tasks. Contrast with *low-level programming language*.

`</html>`—the tag that ends every HTML document.

`<html>`—the tag that begins every HTML document.

**HTML, or Hypertext Markup Language**—a simple language used to create Web pages for the Internet.

## I

**identifier**—the name of a program component such as a class, object, or variable.

**if statement**—the single-alternative decision statement.

**if...else statement**—the statement that provides the mechanism to perform one action when a Boolean expression evaluates as `true`, and to perform a different action when a Boolean expression evaluates as `false`.

**image**—a likeness of a person or thing.

**immutable**—describes objects that cannot be changed.

**implementation**—the actions that execute within a method; the method body.

**implementation hiding**—a principle of object-oriented programming that describes the encapsulation of method details within a class.

**implicit conversion**—the automatic transformation of one data type to another. Also called *promotion*.

**import statement**—a Java statement that allows access to a built-in Java class that is contained in a package.

**incrementing**—the act of adding 1 to a variable.

**indefinite loop**—a loop in which the final number of iterations is unknown. Contrast with *definite loop*.

**indexOf() method**—a `String` class method that determines whether a specific character occurs within a `String`. If it does, the method returns the position of the character; the first position of a `String` begins with zero. The return value is `-1` if the character does not exist in the `String`.

**infinite loop**—a loop that never ends.

**information hiding**—the object-oriented programming principle used when creating private access for data fields; a class’s private data can be changed or manipulated only by a class’s own methods, and not by methods that belong to other classes.

**inheritance**—a mechanism that enables one class to inherit, or assume, both the behavior and the attributes of another class.

**init() method**—the first method called in any applet.

**initialization**—the act of making an assignment at the time of variable declaration.

**inlining**—an automatic process that optimizes performance in which calls to `final` methods are replaced with the expanded code of their definitions at each method call location.

**inner block**—a block contained in an outer block. See also *inside block*.

**inner classes**—nested classes that require an instance. See also *nonstatic member classes*.

**inner loop**—a loop that is contained entirely within another loop.

**input dialog box**—a GUI object that asks a question and provides a text field in which the user can enter a response.

**insert() method**—a `StringBuilder` class method that lets you add characters at a specific location within a `StringBuilder` object.

**inside block**—a block contained in an outside block. See also *inner block*.

**instance**—an existing object of a class.

**instance methods**—methods used with object instantiations. See also *nonstatic methods*.

**instance variables**—the data components of a class.

**instanceof operator**—an operator that determines whether an object that is the operand on the left is a member or descendant of the class that is the operand on the right.

**instantiate**—to create an instance; to create an object.

**instantiation**—an object; one tangible example of a class.

**int**—the data type used to store integers.

**integer**—a whole number without decimal places.

**Integer class**—a wrapper class that contains a simple integer and useful methods to manipulate it.

**integer division**—the operation in which one integer value is divided by another; the result contains no fractional part.

**interactive applications**—programs in which a user communicates with the program by using an input device.

**interactive program**—an application in which the user makes direct requests, as opposed to one in which input comes from a file.

**interface**—a construct similar to a class, except that all of its methods must be abstract and all of its data (if any) must be `static final`; it declares method headers, but not the instructions within those methods. Also used to describe the part of a method that a client sees and uses—it includes the method's return type, name, and arguments.

**interpreter**—a program that translates language statements into machine code. An interpreter translates and executes one statement at a time. Contrast with *compiler*.

**invoke**—to call or execute a method.

**is-a relationship**—the relationship between an object and the class of which it is a member.

**iteration**—one loop execution.

## J

**JApplet**—a Swing class from which you can inherit to create your own applet.

**Java**—a programming language developed by Sun Microsystems as an object-oriented language used both for general-purpose business applications and for interactive,

World Wide Web-based Internet applications.

**Java API**—the application programming interface, a collection of information about how to use every prewritten Java class.

**Java applications**—stand-alone Java programs.

**Java ARchive (JAR) file**—a file that compresses the stored data.

**Java Enterprise Edition (EE)**—a Java edition that includes all of the classes in the Java SE, plus a number of classes that are more useful to programs running on servers.

**Java Foundation Classes (JFC)**—selected classes from the `java.awt` package, including Swing component classes.

**Java interpreter**—the program that checks bytecode and communicates with the operating system, executing the bytecode instructions line by line within the Java virtual machine.

**Java Micro Edition (ME)**—a Java platform that is used for small devices such as PDAs, cell phones, and other consumer appliances.

**Java SE 7**—the most recent version of Java. The full, official name is Java Platform, Standard Edition 7.

**Java Virtual Machine (JVM)**—a hypothetical (software-based) computer on which Java runs.

**java.lang**—the package that is implicitly imported into every Java program and that contains the fundamental classes.

**Javadoc**—a documentation generator created by Sun Microsystems that allows you to generate Application Programming Interface (API) documentation in

Hypertext Markup Language (HTML) format from Java source code.

**Javadoc comment**—a special form of block comment that provides a standard way to document Java code.

**Javadoc tag**—a keyword within a comment that the Javadoc tool can process.

**JButton**—a Component the user can click with a mouse to make a selection.

**JCheckBox**—a UI component that consists of a label positioned beside a square; you can click the square to display or remove a check mark. Usually, you use a `JCheckBox` to allow the user to turn an option on or off.

**JComboBox**—a UI component that combines two features: a display area showing an option and a list box containing additional options. The display area contains either a button that a user can click or an editable field into which the user can type.

**JDK**—the Java Standard Edition Development Kit.

**JFrame**—a container with a title bar and border.

**JLabel**—a built-in Java Swing class that holds text you can display.

**JOptionPane**—a Java class that produces dialog boxes.

**JPanel**—a plain, borderless surface that can hold lightweight UI components.

**JScrollPane**—a pane that provides scroll bars along the side or bottom, or both, so that the user can scroll initially invisible parts of the pane into view.

**JTextField**—a component into which a user can type a single line of text data.

**junction styles**—styles applied to lines that join; they include JOIN\_MITER, JOIN\_ROUND, and JOIN\_BEVEL.

## K

**K & R style**—the indent style in which the opening brace follows the header line; it is named for Kernighan and Ritchie, who wrote the first book on the C programming language. Contrast with *Allman style*.

**key field**—the field in a record that makes the record unique from all others.

**keyboard buffer**—a small area of memory where keystrokes are stored before they are retrieved into a program. Also called the *type-ahead buffer*.

**KeyListener interface**—an interface that provides methods that respond to actions the user initiates from the keyboard. The `KeyListener` interface contains three methods—`keyPressed()`, `keyTyped()`, and `keyReleased()`.

## L

**late binding**—the ability of an application to select the correct subclass method when the program executes. See also *dynamic method binding*.

**layout manager**—a class that controls component positioning in a UI environment.

**leading**—one of three measures of a `Font`'s height; it is the amount of space between baselines. See also *ascent* and *descent*.

**leaf menu item**—a menu item that does not bring up another menu.

**Length field**—a field that contains the number of elements in an array.

**Length() method**—a `String` class method that returns the length of a `String`.

**length property**—a `StringBuilder` class attribute that identifies the number of characters in the `String` contained in the `StringBuilder`.

**lexicographical comparison**—a comparison based on the integer Unicode values of characters.

**library of classes**—a folder that provides a convenient grouping for classes.

**lightweight components**—components written completely in Java that do not have to rely on the code written to run in the local operating system. Contrast with *heavyweight components*.

**line comments**—comments that start with two forward slashes ( `//` ) and continue to the end of the current line. Line comments can appear on a line by themselves or at the end of a line following executable code. Contrast with *block comments*.

**listener**—an object that is interested in and reacts to an event.

**literal constant**—a value that is taken literally at each use.

**literal string**—a series of characters that appear exactly as entered. Any literal string in Java appears between double quotation marks.

**local classes**—nested classes that are local to a block of code.

**local variable**—a variable known only within the boundaries of a method.

**logic**—describes the order of program statements that produce correct results.

**logic error**—an error that occurs when a program compiles successfully but produces an error during execution.

**logical AND operator**—an operator used between Boolean expressions to determine whether both are true. The AND operator is written as two ampersands ( `&&` ).



**logical OR operator**—an operator used between Boolean expressions to determine whether either expression is `true`. The OR operator is written as two pipes (`||`).

**Long**—the data type that holds very large integers, from `-9,223,372,036,854,775,808` to `9,223,372,036,854,775,807`.

**look and feel**—describes the default appearance and behavior of any user interface.

**loop**—a structure that allows repeated execution of a block of statements.

**loop body**—the block of statements that executes when the Boolean expression that controls the loop is `true`.

**loop control variable**—a variable whose value determines whether loop execution continues.

**loop fusion**—the technique of combining two loops into one.

**lossless data compression**—a set of rules that allows an exact replica of data to be reconstructed from a compressed version.

**low-level programming language**—a language that corresponds closely to a computer processor's circuitry. Contrast with *high-level programming language*. Compare with *machine language*.

**lvalue**—an expression that can appear on the left side of an assignment statement. Contrast with *rvalue*.

## M

**machine language**—circuitry-level language; a series of on and off switches. Compare with *low-level programming language*.

**magic number**—a value that does not have immediate, intuitive meaning or a number that cannot be explained without additional knowledge. Unnamed constants are magic numbers.

**matrix**—a two-dimensional array.

**member-level Javadoc comments**—Javadoc comments that describe the fields, methods, and constructors of a class.

**menu bar**—a horizontal strip that is placed at the top of a container and that contains user options.

**menus**—lists of user options.

**method**—a program module that contains a series of statements that carry out a task.

**method declaration**—the header, or first line of a method.

**method's type**—the method's return type.

**mission critical**—describes any process that is crucial to an organization.

**mnemonic**—a key that causes an already visible menu item to be chosen.

**modulus operator**—the percent sign; when it is used with two integers, the result is an integer with the value of the remainder after division takes place. Also called the *remainder operator*; sometimes called just *mod*.

**MouseEvent**—the type of event generated by mouse manipulation.

**MouseListener interface**—an interface that implements all the methods in both the `MouseListener` and `MouseMotionListener` interfaces.

**MouseListener interface**—an interface that provides methods named `mousePressed()`, `mouseClicked()`, and `mouseReleased()` that are analogous to the keyboard event methods `keyPressed()`, `keyTyped()`, and `keyReleased()`.

**MouseMotionListener interface**—an interface that provides methods named `mouseDragged()` and `mouseMoved()` that detect the mouse being rolled or dragged across a component surface.

**multidimensional arrays**—arrays that contain two or more dimensions.

**multimedia**—describes the use of sound, images, graphics, and video in computer programs.

**multiple inheritance**—the capability to inherit from more than one class; Java does not support multiple inheritance.

**multiply and assign operator**—an operator that alters the value of the operand on the left by multiplying the operand on the right by it; it is composed of an asterisk and an equal sign.

**mutator methods**—methods that set field values.

## N

**named constant**—a named memory location whose value cannot change during program execution; in Java, its declaration includes the keyword `final`.

**NaN**—a three-letter abbreviation for “Not a number.”

**nested**—describes the relationship of statements, blocks, or classes when one contains the other.

**nested classes**—classes contained in other classes.

**nested if statements**—describes `if` statements when one is contained within the other.

**new operator**—an operator that allocates the memory needed to hold an object.

**nonstatic member classes**—nested classes that require an instance. See also *inner classes*.

**nonstatic methods**—methods used with object instantiations. See also *instance methods*.

**nonvolatile storage**—storage that does not require power to retain information. Contrast with *volatile storage*.

**NOT operator**—the exclamation point (!); it negates the result of any Boolean expression.

**null String**—an empty `String` created by typing a set of quotes with nothing between them.

**numeric constant**—a number whose value is taken literally at each use.

## O

**Object class**—a class defined in the `java.lang` package, which is imported automatically every time you write a program and is the base class for all other Java classes.

**object-oriented programming**—a style of programming that involves creating classes, creating objects from those classes, and creating applications that use those objects. Contrast with *procedural programming*.

**objects**—instances of a class; objects are made up of attributes and methods.

**octothorpe**—the pound sign.

**one-dimensional array**—an array that contains one column of values and whose elements are accessed using a single subscript. See also *single-dimensional array*.

**opening a file**—the action that creates an object and associates a stream of bytes with it.

**operand**—a value used in an arithmetic statement.

**operator precedence**—the rules for the order in which parts of a mathematical expression are evaluated.

**optional classes**—classes that reside in packages that must be explicitly imported into your programs. Contrast with *fundamental classes*.

**outer block**—a block that contains a nested block. See also *outside block*.

**outer loop**—a loop that contains another loop.

**outside block**—a block that contains a nested block. See also *outer block*.

**overloading**—describes using one term to indicate diverse meanings, or writing multiple methods with the same name but with different arguments.

**overriding a method**—a technique in which you create a method in a child class that has the same name and argument list as a method in its parent class.

**overrides**—describes what a variable does to another with the same name when it takes precedence over the other variable.

## P

**package**—a named collection or library of classes. See also *class library* and *library of classes*.

**paint() method**—a method that runs when Java displays a screen; you can write your own `paint()` method to override the automatically supplied one whenever you want to paint graphics, such as shapes, on the screen.

**painting**—the act of displaying or redisplaying a surface.

**parallel array**—an array with the same number of elements as another, and for which the values in corresponding elements are related.

**parameters**—data items received by a method.

**parent class**—a base class.

**parse**—to break into component parts; the process the compiler uses to divide source code into meaningful portions for analysis.

**parseDouble() method**—a `Double` class method that takes a `String` argument and returns its `double` value.

**parseInt() method**—an `Integer` class method that takes a `String` argument and returns its integer value.

**Pascal casing**—the style of using an uppercase letter to begin an identifier and to start each new word in an identifier. Contrast with *camel casing*.

**passed by reference**—describes a variable passed to a method when the address is passed to the method. Contrast with *passed by value*.

**passed by value**—describes a variable passed to a method when a copy is made in the receiving method. Contrast with *passed by reference*.

**passing**—the act of sending arguments to a method.

**path**—the complete list of the disk drive plus the hierarchy of directories in which a file resides.

**Path class**—a Java class used to work with file information, such as its location, size, creation date, and whether the file exists.

**path delimiter**—the character used to separate path components.

**pattern String**—an argument passed to the `DecimalFormat` constructor that is composed of symbols that determine what a formatted number looks like.

**permanent storage devices**—hardware storage devices that retain data even when power is lost.

**pixels**—the picture elements, or tiny dots of light, that make up the image on your video monitor.

**point size argument**—an argument to the Font constructor that is an integer that represents about 1/72 of an inch.

**polymorphism**—the feature of languages that allows the same word to be interpreted correctly in different situations based on the context; the act of using the same method name to indicate different implementations.

**populating the array**—the act of providing values for all of the elements in an array.

**postfix ++** or the **postfix increment operator**—an operator that is composed by placing two plus signs to the right of a variable; it evaluates the variable, then adds 1 to it. Contrast with *prefix ++*.

**posttest loop**—a loop in which the loop control variable is tested after the loop body executes. Contrast with *pretest loop*.

**preferred size**—a Component's default size.

**prefix ++** or the **prefix increment operator**—an operator that is composed by placing two plus signs to the left of a variable; it adds 1 to the variable, then evaluates it. Contrast with *postfix ++*.

**prefix and postfix decrement operators**—operators that subtract 1 from a variable before and after evaluating it, respectively.

**pretest loop**—a loop in which the loop control variable is tested before the loop body executes. Contrast with *posttest loop*.

**primary key**—a unique identifier for data within a database.

**primary surface**—the visible screen surface during double buffering.

**priming read** or **priming input**—the first input statement prior to a loop that will execute subsequent input statements for the same variable.

**primitive type**—a simple data type. Java's primitive types are `byte`, `short`, `int`, `long`, `float`, `double`, `char`, and `boolean`.

**private access**—refers to a field that no other classes can access.

**procedural programming**—a style of programming in which sets of operations are executed one after another in sequence. Contrast with *object-oriented programming*.

**procedures**—sets of operations performed by a computer program.

**program**—a set of instructions that you write to tell a computer what to do.

**program comments**—nonexecuting statements added to a Java file for the purpose of documentation.

**program files**—files that store software instructions. See also *application files*.

**program statements**—similar to English sentences; they carry out the tasks that programs perform.

**programmer-defined data type**—a type that is created by a programmer and not built into the language.

**promotion**—an implicit conversion.

**prompt**—a message that requests and describes user input.

**property**—an object; an instance variable or field.

**protected**—a Java keyword that provides you with an intermediate level of security between `public` and `private` access. Protected members are those that can be used by a class and its descendants.

**pseudocode**—a tool that helps programmers plan a program's logic by writing plain English statements.

**pseudorandom**—describes numbers that appear to be random, but are the same set of numbers whenever the seed is the same.

## R

**ragged array**—a two-dimensional array that has rows of different lengths.

**random access files**—files in which records can be located in any order.

**random access memory (RAM)**—temporary, volatile storage.

**random number**—a number whose value cannot be predicted.

**range check**—a series of statements that determine within which of a set of ranges a value falls.

**range match**—the process of comparing a value to the endpoints of numerical ranges to find a category in which the value belongs.

**real-time**—describes applications that require a record to be accessed immediately while a client is waiting.

**record**—a collection of fields that contain data about an entity.

**redeclare a variable**—to attempt to declare a variable twice—an illegal action.

**reference**—a variable that holds a memory address.

**reference to an object**—the name for a memory address where the object is held.

**reference types**—objects that hold memory addresses.

**relational operator**—an operator that compares two items; an expression that

contains a relational operator has a Boolean value.

**relative path**—a path that depends on other path information to be complete.

**remainder and assign operator**—an operator that alters the value of the operand on the left by assigning the remainder when the left operand is divided by the right operand; it is composed of a percent sign and an equal sign ( %= ).

**remainder operator**—the percent sign; when it is used with two integers, the result is an integer with the value of the remainder after division takes place. Also called the *modulus operator*.

**remove() method**—a method that removes components from a container.

**repaint() method**—a method you execute when a window needs to be updated, such as when it contains new images.

**replace() method**—a `String` class method that allows you to replace all occurrences of some character within a `String`.

**rerendered**—describes a drawing that is repainted or redisplayed.

**return statement**—a statement that ends a method, and frequently sends a value from a called method back to the calling method.

**return type**—the type of data that, upon completion of a method, is sent back to its calling method.

**returning a value**—the act of sending a data value from a called method back to the calling method.

**robustness**—describes the degree to which a system is resilient to stress, maintaining correct functioning.

**root directory**—the main directory of a storage device, outside any folders.

**runtime error**—an error that occurs when a program compiles successfully but does not execute.

**runtime exceptions**—unplanned exceptions that occur during a program's execution. The term is also used more specifically to describe members of the `RuntimeException` class.

**rvalue**—an expression that can appear only on the right side of an assignment statement. Contrast with *lvalue*.

## S

**sandbox**—a safe area in which a program can run without causing harm to other areas of a system.

**scalar**—describes simple, primitive variables, such as `int`, `double`, or `char`.

**scientific notation**—a display format that more conveniently expresses large or small numeric values; a multidigit number is converted to a single-digit number and multiplied by 10 to a power.

**scope**—in reference to a variable, the portion of a program within which you can refer to the variable.

**SDK**—a software development kit, or a set of tools useful to programmers; the Java EE Development Kit.

**searching an array**—the process of comparing a value to a list of values in an array, looking for a match.

**seed**—a starting value.

**seekable**—describes a file channel in which you can search for a specific file location and in which operations can start at any specified position.

**semantic errors**—the type of errors that occur when you use a correct word in the wrong context in program code.

**sequence structure**—a logical structure in which one step follows another unconditionally.

**sequential access file**—a data file in which each record is stored in order, based on the value in some field.

**setCharAt() method**—a `StringBuilder` class method that allows you to change a character at a specified position within a `StringBuilder` object.

**setEditable() method**—a method that changes the editable status of a `JTextField`.

**setEnabled() method**—a method that makes a component available or dimmed and unavailable.

**setFont() method**—a method that changes a `JLabel`'s font.

**setLength() method**—a `StringBuilder` class method that changes the length of the characters in the `String` in a `StringBuilder` object.

**setLocation() method**—a method that allows you to place a component at a specific location within a `JFrame`'s content pane.

**setStroke() method**—a Java 2D method that alters a stroke's width.

**setText() method**—a method that allows you to change the text in a `Component` that has already been created.

**setToolTipText() method**—a method that defines the text to be displayed in a tool tip.

**short**—the data type that holds small integers, from  $-32,768$  to  $32,767$ .

**short-circuit evaluation**—describes the feature of the AND and OR operators in which evaluation is performed only as far as necessary to make a final decision.

**showInputDialog() method**—a method that creates an input dialog box.

**signature**—a method's name and the number, types, and order of arguments.

**significant digits**—refers to the mathematical accuracy of a value.

**single-alternative if**—a decision structure that performs an action, or not, based on one alternative. Contrast with *dual-alternative if*.

**single-dimensional array**—an array that contains one column of values and whose elements are accessed using a single subscript. See also *one-dimensional array*.

**single-precision floating-point number**—a type of value that is stored in a `float`.

**sorting**—the process of arranging a series of objects in some logical order.

**source**—a component on which an event is generated.

**source code**—programming statements written in a high-level programming language.

**stack trace history list**, or more simply **stack trace**—a list that displays all the methods that were called during program execution.

**standard input device**—normally the keyboard.

**standard output device**—normally the monitor.

**start() method**—a method that executes after the `init()` method in an applet and executes again every time the

applet becomes active after it has been inactive.

**startsWith() method**—a `String` class method that takes a `String` argument and returns `true` or `false` if a `String` object does or does not start with the specified argument, respectively.

**state**—the values of the attributes of an object.

**static**—a keyword that means a method is accessible and usable even though no objects of the class exist.

**static member class**—a type of nested class that has access to all `static` methods of its top-level class.

**static method binding**—the opposite of dynamic method binding; it occurs when a subclass method is selected while the program compiles rather than while it is running. See also *fixed method binding*.

**stop() method**—a method invoked in an applet when a user leaves a Web page (perhaps by minimizing a window or traveling to a different Web page).

**stream**—a pipeline or channel through which bytes flow into and out of an application.

**StringBuilder and StringBuffer classes**—classes used to store and manipulate changeable data composed of multiple characters. It is an alternative to the `String` class when you know a `String` will be modified.

**String class**—a class used to work with fixed-string data—that is, unchanging data composed of multiple characters.

**String variable**—a named object of the `String` class.

**stringWidth() method**—a `FontMetrics` class method that returns the integer width of a `String`.

**stroke**—a line-drawing feature in Java 2D that represents a single movement as if you were using a drawing tool, such as a pen or a pencil.

**strongly typed language**—a language in which all variables must be declared before they can be used.

**style argument**—an argument to the `Font` constructor that applies an attribute to displayed text and is one of three values: `Font.PLAIN`, `Font.BOLD`, or `Font.ITALIC`.

**subclass**—a derived class.

**subscript**—an integer contained within square brackets that indicates one of an array's variables, or elements.

**substring() method**—a `String` class method that allows you to extract part of a `String`.

**subtract and assign operator**—an operator that alters the value of the operand on the left by subtracting the operand on the right from it; it is composed of a minus sign and an equal sign (`--`).

**subtype polymorphism**—the ability of one method name to work appropriately for different subclasses of a parent class.

**super**—a Java keyword that always refers to the superclass of the class in which you use it.

**superclass**—a base class.

**Swing components**—UI elements such as dialog boxes and buttons; you can usually recognize their names because they begin with `J`.

**switch statement**—a statement that uses up to four keywords to test a single variable against a series of exact integer or character values. The keywords are `switch`, `case`, `break`, and `default`.

**symbolic constant**—a named constant.

**syntactic salt**—describes a language feature designed to make it harder to write bad code.

**syntactic sugar**—describes aspects of a computer language that make it “sweeter,” or easier, for programmers to use.

**syntax**—the rules of a language.

**syntax error**—a programming error that occurs when you introduce typing errors into a program or use the programming language incorrectly. A program containing syntax errors will not compile.

**System.out.printf() method**—a method used to format numeric values.

**system-triggered painting**—painting operations that occur when the system asks a component to render its contents. Contrast with *application-triggered painting*.

## T

**table**—a two-dimensional array; a matrix.

**tag attributes**—arguments that promote activity or describe the features of an HTML tag.

**tags**—HTML commands.

**ternary operator**—an operator that needs three operands.

**text files**—files that contain data that can be read in a text editor because the data has been encoded using a scheme such as ASCII or Unicode.

**this reference**—a reference to an object that is passed to any object's nonstatic class method.

**thread**—the flow of execution of one set of program statements.



**throw statement**—a statement that sends an `Exception` out of a block or a method so it can be handled elsewhere.

**TOCTTOU bug**—an error that occurs when changes take place from Time Of Check To Time of Use.

**token**—a unit of data; the `Scanner` class separates input into tokens.

**toLowerCase() method**—a `String` class method that converts any `String` to its lowercase equivalent.

**tool tips**—popup windows that can help a user understand the purpose of components in an application; a tool tip appears when a user hovers a mouse pointer over the component.

**top-level class**—the containing class in nested classes.

**top-level container**—a container at the top of a containment hierarchy. The Java top-level containers are `JFrame`, `JDialog`, and `JApplet`.

**toString() method**—an `Object` class method that converts an `Object` into a `String` that contains information about the `Object`. Also, a `String` class method that converts any object to a `String`.

**toUpperCase() method**—a `String` class method that converts any `String` to its uppercase equivalent.

**try block**—a block of code you attempt to execute while acknowledging that an exception might occur.

**two-dimensional array**—an array that contains two or more columns of values and whose elements are accessed using multiple subscripts. Contrast with *one-dimensional array*.

**type-ahead buffer**—the keyboard buffer.

**type casting**—an action that forces a value of one data type to be used as a value of another type.

**typeface argument**—an argument to the `Font` constructor that is a `String` representing a font. Common fonts have names such as Arial, Century, Monospaced, and Times New Roman.

**type-wrapper classes**—a method that can process primitive type values.

## U

**UI components**—user interface components, such as buttons and text fields, with which the user can interact.

**unary cast operator**—a more complete name for the cast operator that performs explicit conversions.

**unary operator**—an operator that uses only one operand.

**unchecked exceptions**—exceptions that cannot reasonably be expected to be recovered from while a program is executing. Contrast with *checked exceptions*.

**Unicode**—an international system of character representation.

**Unified Modeling Language (UML)**—a graphical language used by programmers and analysts to describe classes and object-oriented processes.

**unifying type**—a single data type to which all operands in an expression are converted.

**unreachable statements**—statements that cannot be executed because the logical path can never encounter them; in Java, an unreachable statement causes a compiler error. See also *dead code*.

**upcast**—to change an object to an object of a class higher in its inheritance hierarchy.

## V

**validating data**—the process of ensuring that a value falls within a specified range.

**variable**—a named memory location that you can use to store a value.

**variable declaration**—a statement that reserves a named memory location.

**viewport**—the viewable area in a `JScrollPane`.

**virtual classes**—the name given to abstract classes in other programming languages, such as C++.

**virtual key codes**—codes that represent keyboard keys that have been pressed.

**virtual method calls**—method calls in which the method used is determined when the program runs, because the type of the object used might not be known until the method executes. In Java, all instance method calls are virtual calls by default.

**void**—a keyword that, when used in a method header, indicates that the method does not return any value when it is called.

**volatile storage**—memory that requires power to retain information. Contrast with *nonvolatile*.

## W

**Web browser**—a program that allows you to display HTML documents on your computer screen.

**while loop**—a construct that executes a body of statements continually as long as the Boolean expression that controls entry into the loop continues to be `true`.

**whitespace**—any combination of nonprinting characters; for example, spaces, tabs, and carriage returns (blank lines).

**wildcard symbol**—an asterisk; a symbol used to indicate that it can be replaced by any set of characters. In a Java `import` statement, you use a wildcard symbol to represent all the classes in a package.

**window decorations**—the icons and buttons that are part of a window or frame.

**windowed applications**—programs that create a graphical user interface (GUI) with elements such as menus, toolbars, and dialog boxes.

**wrapped**—to be encompassed in another type.

**wrapper**—a class or object that is “wrapped around” a simpler element.

**“write once, run anywhere” (WORA)**—a slogan developed by Sun Microsystems to describe the ability of one Java program version to work correctly on multiple platforms.

## X

**x-axis**—an imaginary horizontal line that indicates screen position.

**x-coordinate**—a value that increases as you travel from left to right across a window.

**XHTML**—Extensible Hypertext Markup Language, an extension of HTML.

## Y

**y-axis**—an imaginary vertical line that indicates screen position.

**y-coordinate**—a value that increases as you travel from top to bottom across a window.

# Index

- & (ampersand), 225
- <> (angle brackets), 37–38, 829
- \* (asterisk), 22, 185
- @ (at sign), 481, 906
- \ (backslash), 65, 581, 591
- : (colon), 236, 583
- , (comma), 112, 586, 592, 893–894
- { (curly braces), 17, 18, 37–38, 106, 121, 158, 219–220, 389, 525
- \$ (dollar sign), 15, 892
- " (double quotes), 13, 64
- = (equal sign), 53, 93, 214
- ! (exclamation point), 237–238
- / (forward slash), 22, 39, **581**
- (minus sign), 427
- () (parentheses), 14, 17, 37–38, 105, 106, 109, 273, 525
- % (percent sign), 889
- . (period), 14, 893
- # (pound sign), 17, 893
- + (plus sign), 10, 68, 314, 427, 434
- ? (question mark), 236
- ; (semicolon), 13, 38, 215–216, 264, 274, 471
- [] (square brackets), 37–38, 401
- \_ (underscore), 15, 52
- A**
- abs method, 183
- absolute path, **582**
- abstract classes, 449, **470**, 471–474, 491, 496–500
- abstract data types (ADTs), **135**
- abstract keyword, 16, 471
- abstract methods, **470**, 471, 726
- abstraction, **105**. *See also* abstract classes; abstract methods
- accelerator, **744**
- access modifiers. *See* access specifiers
- access specifiers, 121, 492, 660, 661
  - described, **17**
  - inheritance and, 442, 494
  - Javadoc and, 911–912
  - overview, 105
- accessor methods, **125**, 313
- accumulating, **270**
- action keys, **728**
- ActionListener interface, 665–666, 669–671, 726, 727
- actionPerformed method, **665**, 666, 667, 668, 712, 726–727, 772, 773, 774, 741, 833, 834, 841
- acyclic gradient, **792**
- adapter classes, **726**
- add and assign operator, **270**
- add method, 399, **650**, 700–702, 706, 712, 715, 717, 720, 739
- addActionListener method, **665**, 667, 670, 727
- addAdjustmentListener method, 670
- AddChangeListener method, 670
- addFocusListener method, 665, 670, 730
- addItem method, 677, 678
- addItemListener method, 670, 727
- addition operator, 69
- addKeyListener method, 665
- AddMouseListener method, 670
- addPoint method, **786**
- addressString variable, 321
- addSeparator method, 743
- AddWindowListener method, 670
- ad-hoc polymorphism, **476**
- AdjustmentListener interface, 670, 671, 727
- ADTs (abstract data types), **135**
- AgeCalculator class, 187–188
- aggregation, **429**
- aGreeting variable, 307, 308, 309
- AirlineDialog class, 85–87
- Airplane class, 9
- Allman, Eric, 18
- Allman style, **18**
- ambiguity, 167–168, **169**, 170–171
- aNewLine variable, 65
- Animal class, 471–477, 480–481, 488, 495
- AnimalArrayDemo class, 478
- AnimalReference class, 474–475
- anonymous objects, **307**
- anotherNumber variable, 159
- API (Application Program Interface), **32**, 910, 911
- append method, 322
- Apple Computer, 262
- applet(s)
  - described, **12**
  - hosting, writing HTML documents for, 828–830, 846
  - life cycle, 850–854
  - overview, 825–868
  - running, 827–828, 846–848
- Applet Viewer, 827, 831–832, 836
- appletviewer command, **827**, 831, 836
- application files. *See* programs
- applications. *See also* Java applications
  - described, **5**
  - fault-tolerant, **524**
  - interactive, **11**, 608
  - real-time, **608**
  - windowed, **12**
- applyBraces method, 431
- Appraisal class, 192
- architecture neutrality, 10
- arcs, 780, 781, 783–784, 786
- areas, copying, 786–787, 803–804

- argument(s)
    - constructors that require, 436–438
    - described, **14**
    - drawing arcs and, 783
    - file input/output and, 585–586, 597, 608
    - get method and, 186–188
    - index, **892**
    - methods that accept, 140–141
    - methods that do not require, 137–139
    - overview, 108
    - passing, **14**, 20
    - superclasses that require, 456–458
    - Swing components and, 652
  - arithmetic
    - operators, **69**, 270–272
    - performing, 67–73, 90–91
    - statements, efficient writing of, 71
  - ArithmeticException, 522, 526–527, 530–531, 532, 536, 543, 548
  - array(s). *See also* array elements
    - advanced concepts, 381–424
    - creating, 363
    - declaring, 342–246
    - described, **342**
    - initializing, 342–246, 363–364
    - multidimensional, **392**
    - of objects, 349–352, 477–479
    - one-dimensional, **388**, 389–390
    - overview, 341–380
    - parallel, **353**, 354, 364–365
    - passing, 359–362, 369–370
    - populating, **345**, 363
    - ragged, **392**
    - returning, 359–362
    - searching, 352, 353, **354**, 355–358
    - of Strings, 350–352
    - two-dimensional, **388**, 389–393, 409–411
    - wrapped, **608**
  - array elements. *See also* arrays
    - accessing, 364
    - described, **343**
    - sorting, 382–387
  - ArrayIndexOutOfBoundsException
    - Exception, 543, 545
  - ArrayList class, 398–404
  - ArrayListDemo class, 400–401
  - ArrayListDemo2 class, 402
  - Arrays class, **393**, 394–398, 411–413
  - ArraysDemo class, 394–395
  - ascending order, **382**, 394
  - ascent, **790**
  - ASCII (American Standard Code for Information Interchange), **580**, 882
  - assert keyword, 16
  - assert statement, **552**
  - assertions
    - described, **552**
    - using, 551–555
  - assignment operator, **53**, 216, 239
  - associativity, **53**, 54
  - aTabChar variable, 65
  - atan method, 183
  - atan2 method, 184
  - attribute(s)
    - described, 7
    - determining, 588–591
    - file input/output and, 588–591
    - rendering, specifying, 792–793
  - Attributes class, 588
  - Automobile class, 8, 7, 9, 487
  - AWTEvent class, 725, 730–732
- ## B
- BankAccount class, 481–482, 484–486
  - BankBalance class, 267–268
  - BankBalance2 class, 276–277
  - BankBalanceByRateAndYear class, 279–280
  - BankLoan class, 115
  - base classes, **429**
  - BaseBallPlayer class, 179, 443–444
  - BASIC, 216
  - BasicFileAttributes class, 588
  - BasicStroke interface, 794
  - BasketBallPlayer class, 446–448
  - batch processing, **607**
  - billPatients method, 431
  - binary digits (bits), **879**
  - binary files, **580**
  - binary numbering system, **878**, 879
  - binary operators, **69**
  - binary searches, 395–397
  - binarySearch method, 395, 397
  - bits (binary digits), **879**
  - black box, **109**
  - blank final, **55**
  - blitting (block line transfer), **716**
  - block(s)
    - comments, **22**
    - described, **158**
    - inside/inner, **158**
    - line transfer, **716**
    - nested, **158**
    - outside/outer, **158**
    - overview, 158–165
    - scope, demonstrating, 193–194
  - Boole, George, 59, 213
  - boolean data type
    - described, **213**
    - overview, 52, 59–61
  - boolean keyword, 16, 52
  - Boolean operators, 59
  - boolean variables, **59**
  - Boolean values, 116, 213–215, 217–218, 260
  - BorderLayout layout manager, 654, 655, 706, 707–708, 717, 744–747
  - BoxLayout layout manager, 706, **714**
  - break keyword, 16, 233
  - break statements, 356
  - browser(s)
    - described, **828**
    - Javadoc and, 909–910
    - running applets in, 828–830, 847–848
  - bubble sort, **382**, 383–387
  - bubbleSort method, 386–387
  - buffer(s)
    - back, **716**
    - described, **320**
    - keyboard, **79**
    - overview, 591–594
    - writing records and, 612
  - BufferedInputStream class, 595
  - BufferedOutputStream class, 595, 597–599
  - BufferedReader class, 596, 600, 601, 604
  - BufferedWriter class, 596, 601, 603, 612
  - buffering, double, **716**
  - Business class, 429
  - BusinessLetter class, 315–316
  - ButtonGroup class, **676**
  - byte data type, **52**, 57
  - byte keyword, 16, 52
  - ByteBuffer class, 608, 609
  - ByteChannel class, 609
  - bytecode, **11**
- ## C
- C++ (high-level language), 73, 216, 361, 470
    - exception handling and, 536
    - inheritance and, 470, 487
    - modeling of Java after, 12

- C# (high-level language), 361, 536
- calculateInterest method, 165–166, 169–170
- calculateInterestUsingDouble method, 167
- calculateInterestUsingInt method, 167
- calculatePay method, 478
- Calendar class, 470
- call stacks
  - described, **544**
  - tracing exceptions through, 544–547
- CallSimpleMethod class, 168–169
- camel casing, **53**
- capacity
  - of classes, 398
  - of objects, **320**
- capacity method, **320**
- CardGame class, 491
- CardLayout layout manager, 706, **712**, 713–714, 749–751
- case keyword, 16, 233, 235
- case sensitivity, 15, 24, 38
- cast operator, **74**, 403
- catch blocks, **525**, 526–529
- catch keyword, 16, 536
- catch method, 525
- catch or specify requirement, **541**
- CD command, 24
- ceil method, 184
- ChangeListener interface, 670
- char data type, **52**, 62–66
- char keyword, 16, 52
- character(s)
  - described, **591**
  - manipulating, 303–306
  - values, representing, 881–882
  - writing, to random access files, 611–618
- Character class, **303**, 304–306
- charAt method, 77, 304, **313**, 322, 396
- checkAccess method, 585, 586
- CheckBoxDemonstration class, 673–674
- Checkerboard class, 720–721
- child classes, **429**
- class(es). *See also specific classes*
  - adapter, **726**
  - adding comments to, 21–23, 34–35
  - anonymous, **191**
  - base, **429**
  - body, **17**
  - child, **429**
  - clients/users, **120**
  - composition and, 189–191
  - concepts, 118–120
  - concrete, **470**
  - creating, 1–49, 120–122, 145
  - as data types, 134–137
  - definitions, 7
  - described, 7
  - diagrams, **426**
  - dynamically resizable, **398**
  - explicitly imported, 198–199
  - extended, 121, 430–432, 656–659
  - fragile, **442**
  - fundamental, **182**
  - headers, 120–121
  - inner, **191**, 192–193
  - that instantiate objects of another class, 143–144
  - level Javadoc comments, **906**, 907
  - local, **191**
  - methods, **178**
  - modifying, 25–27, 35–36
  - names, 495
  - nested, **191**, 192–193
  - organizing, 129–132
  - prewritten, 198–199
  - private, 192
  - reusability of, 118–119
  - saving, 23
  - top-level, **191**
  - type-wrapper, **83**
  - using, 103–155
  - variables, **179**
  - wrapper, **317**, 318
- class keyword, 16, 120
- class variable, 872
- classpath settings, 186
- clean build, **25**
- clearRect method, **779**
- clearRoundRect method, 781
- clone method, 480
- close method, 596, 600, 603
- closePath method, 797
- COBOL, 216
- code
  - byte-, **11**
  - dead, **116**
  - editing, 874
  - hash, **481**, 483
  - indentation, 18–19, 218, 219, 224
  - inlining, **448**
  - pseudo-, **212**
  - saving, 874
  - source, **11**, 874
- collisions, **495**
- color
  - applets and, 832, 834
  - graphics and, 770, 774, 777–778
  - menus and, 738–739
  - using, 702–705, 799
- Color class, 702–705
- command(s)
  - described, **3**
  - prompt, **78**, 871, 909
- comment(s)
  - adding, 21–23, 34–35
  - Javadoc, **22**, 906–911
  - “out,” use of the term, **21**, 22
- CompareConcatenationTime class, 323
- CompareLoops class, 283
- CompareStrings class, 310
- compareTo method, **311**, 312, 405, 407, 589
- comparison operator, **59**
- comparisonsToMake variable, 384–385
- compilers, 18, 126, 170, 544. *See also* compile-time errors
  - arrays and, 403
  - constructors and, 132–133
  - decisions and, 224
  - described, **2**
  - filename extensions and, 23
  - overview, 23–25, 873–874
- compile-time errors, 24, 116, 444–445, 470
  - correcting, 29–32
  - described, **30**
- component(s). *See also* GUIs (graphical user interfaces); *specific components*
  - applets and, 832–835
  - editable, **660**
  - heavyweight, **644**
  - overview, 7–8
- Component class, 644, 702
- ComponentDemo class, 662–663
- composition, **189**, 190–191, 429
- compression, lossless data, **838**
- ComputeCommission class, 113
- computer files. *See* files
- computer simulations, **6**
- concatenation
  - described, **67**
  - of Strings, **313**
- concrete classes, **470**
- conditional operator, **236**, 237
- conditional OR operator, **226**, 227
- conductExam method, 431

- confirm dialog box, **85**, 86–87
  - console applications, **12**
  - console output, 13–21
  - const keyword, 16
  - constant(s)
    - automatically imported, 182–188
    - creating interfaces to store, 492–494
    - described, 52
    - enum, **404**, 405–409
    - fields, 181–182
    - numeric, **52**
    - overview, 52–57
    - parameters and, 110–111
    - prewritten, 182–188
  - constructor(s). *See also* default constructors
    - adding, 144–145
    - arrays and, 398
    - described, **127**
    - exception handling and, 548
    - inheritance and, 434–438, 454–458, 488
    - layout managers and, 712–713
    - overloaded, 172–173, 176–178, 196–198
    - overview, 132–134
    - Swing components and, 650
    - used with parameters, 171–173
  - consumed entries, **80**
  - Container class, 644, 705, 707
  - containers, **644**
  - containment hierarchy, **700**
  - content pane, **700**, 701–702
  - continue keyword, 16
  - ContractEmployee class, 433, 470
  - controls, use of the term, 644
  - ConversionCharacterExamples class, 890
  - Convertible class, 9
  - ConvertStringToInteger class, 317–318
  - copyArea method, **786**, 787
  - cos method, 184
  - counter-controlled loops. *See* definite loops
  - counting, **270**
  - Cow class, 472, 474–478
  - CREATE constant, 597
  - CREATE\_NEW constant, 597
  - CreateEmployeesRandomFile class, 615–617
  - CreateOneRandomAccessRecord class, 613–616
  - CreateTwoMyFrameObjects class, 657–658
  - creationTime method, 588
  - CSV (comma-separated values), 401, **592**, 604
  - currentTimeMillis method, 283
  - Customer class, 438–439
  - CustomerAccount class, 549
  - cyclic gradients, **793**
- D**
- data. *See also* data types; files
    - accepting, 89–90
    - compression, lossless, **838**
    - displaying, 67–73
    - hiding, 128–129
    - representation, 877–883
    - using, 51–102
  - data types. *See also specific data types*
    - arrays and, 360, 392
    - casting data and, 83
    - classes as, 134–137
    - described, **52**
    - inheritance and, 437
    - method overloading and, 170
    - numeric type conversion and, 73–75
    - parameters and, 109–110
    - programmer-defined, **135**
    - Strings and, 314
    - type-safe, **408**
  - dead code, **116**
  - DebateStudent class, 476
  - debugging, **3**. *See also* errors
  - decimal numbering system, **878**, 880, 886–887, 891
  - DecimalFormat class, **893**, 894
  - decision(s)
    - accurate/efficient, making, 227–232
    - logic of, planning, 212–214
    - making, 211–258
    - structure, **213**
  - DeclareTwoEmployees class, 127–128
  - default constructors, **133**, 398, 436–438. *See also* constructors
  - default keyword, 16, 233
  - definite loops, 288–289. *See also* loops
  - delete method, 583, 587–588
  - deleteIfExists method, 583, 588
  - DemoConstructors class, 435–436
  - DemoRaise class, 111
  - DemoStackTrace class, 545, 546
  - DemoStackTrace2 class, 546–537
  - derived classes, **429**
  - descending order, **382**, 384
  - descent, **790**
  - destroy method, 835, **836**, 837
  - dialog boxes
    - creating, 36–37
    - described, **27**
    - producing, 27–29
  - Dimension class, 646
  - direct access files. *See* random access files
  - directories. *See* folders
  - DirectoryNot
    - EmptyException, 587
  - DismissedEmployee class, 529
  - display method, 189, 190, 394, 400, 438
  - DisplayDog class, 480–481
  - displayMessage method, 446
  - displayPrice method, 539–530
  - displayRateOfPay method, 433
  - displayRateOfPayForHourly method, 433
  - DisplayRents class, 391–392
  - displayRules method, 491
  - divide and assign operator, **270**
  - “divide and conquer” procedures, 396
  - Division class, 521–523
  - division operator, 69
  - DivisionMistakeCaught class, 526–527
  - DivisionMistakeCaught2 class, 528
  - DivisionMistakeCaught3 class, 530, 532
  - DivisionMistakeCaught4 class, 532–533
  - do keyword, 16
  - do...while loops, 260, 275, **276**, 277–278
  - documentation. *See also* Javadoc
  - Dog class, 8, 15, 470–472, 474–478, 480–481, 488
  - do-nothing loop, **283**
  - DOS (Disk Operating System), 12, 24, 185, 590, 828
  - double buffering, **716**
  - Double class, 318
  - double data type, **52**, 61, 73–74, 109–110
  - double keyword, 16, 52
  - double-precision floating-point number, **62**
  - draw method, 795

draw3DRect method, **781**, 782  
 drawArc method, **783**, 784, 796  
 drawImage method, 839, 843  
 drawing  
   creating objects for, 795–797  
   with graphics, 792–793  
   strokes, 794–795  
 drawLine method, **778**, 779–780, 785  
 drawOval method, **782**, 783  
 drawPolygon method, **784**, 785–786  
 drawRect method, **779**  
 drawRoundRect method, **780**, 782  
 drawString method, 774, **775**,  
   776–778, 798  
 dual-alternative if statement, **217**  
 dynamic method binding, overview,  
   474, **475**, 476–477  
 dynamically resizable classes, **398**

## E

-ea option, 554–555  
 elements. *See also* See array  
   elements  
 else keyword, 16  
 Elvis operator, 236  
 Employee class, 16, 120–136, 163,  
   171–173, 342, 349, 385–387,  
   426–437, 470, 474, 477–479,  
   907  
 Employee2 class, 907–908, 909, 911  
 EmployeeWithTerritory class,  
   428–432  
 empty statements, **216**  
 encapsulation, **9**  
 endcap styles, **794**  
 endsWith method, **313**  
 EnterSmallValue class, 269, 275–276  
 enum constants, **404**, 405–409  
 enum keyword, 16, 404  
 EnumDemo class, 406–407  
 EnumDemo2 class, 408  
 enumerated data type, **404**, 405–409  
 enumerations, creating, 404–409,  
   413–415  
 equals method, 309–211, 321, 405,  
   **483**, 484–486  
 equivalency operator, **214**, 216, 302  
 error(s). *See also* compile-time  
   errors; exceptions  
   arrays and, 348, 403  
   classes and, 125, 442  
   correcting, 29–32  
   dialog boxes and, 87  
   file input/output and, 594

inheritance and, 442, 444–449, 470  
 logic, 4, **30**, 552  
 run-time, **31**, 551  
 semantic, **3**  
 Swing components and, 679  
 syntax, **3**, 24, 551  
 variable scope and, 164  
 Error class, **520**, 521  
 ErrorTest class, 30–31  
 escape sequences, **65**  
 EvenOdd class, 552–554  
 event(s). *See also* event handling  
   applets and, 849–950  
   closer examination of, 725–730  
   described, **664**  
   -driven programs, **664**, 665–669  
   listeners, **669**, 670–672  
   messages, preparing classes to  
     accept, 665  
   mouse, 725–727, 731, 733–739  
   sources, distinguishing, 684–685  
   telling your class how to respond  
     to, 665–668  
 Event class, 242–246  
 event handling. *See also* events  
   closer examination of, 725–730  
   described, **671**  
   examples, 728–730  
 Evergreen class, 429, 430  
 exception(s). *See also* errors;  
   exception handling;  
   exceptions (listed by name)  
   catching, 525–529, 555–557,  
     560–562  
   categories of, 520  
   checked, **541**  
   creating, 548–551, 563–564  
   dealing with multiple, 530–534  
   file input/output and, 603  
   graphics and, 774  
   learning about, 519–524  
   overview, 115  
   passing, 559–560  
   runtime, **520**, 543, 551  
   specification, **539**, 540–543  
   Strings and, 316  
   throwing, 530–534, 539–543,  
     555–559, 562–563, 603  
   tracing, through call stacks,  
     544–547  
   unchecked, **541**  
 Exception class, **520**, 521, 526  
 exception handling. *See also*  
   exceptions  
   advantages of, understanding,  
     537–538

  catching exceptions, 525–529,  
     555–557, 560–562  
   described, **520**  
   overview, 519–578  
   throwing exceptions, 530–534,  
     539–543, 555–559,  
     562–563, 603  
   try code and, 525–529  
 exceptions (listed by name). *See*  
   also exceptions  
   ArithmeticException, 522,  
     526–527, 530–531, 532,  
     536, 543, 548  
   ArrayIndexOutOfBoundsException  
     Exception, 543, 545  
   DirectoryNotEmptyException, 587  
   IndexOutOfBoundsException, 536  
   InputMismatchException, 522,  
     530–531  
   IOException, 535, 586  
   NoSuchFileException, 587  
   NullPointerException, 548, 774  
   NumberFormatException, 316  
   RuntimeException, 543, 551  
 EXECUTE argument, 585  
 executing  
   programs, 873–874  
   statements, **2**, **3**  
 exists method, 583, 585  
 exit method, 535, 536  
 explicit conversion, **74**  
 extends keyword, 16, 430,  
   431–432, 657

## F

factory methods, **582**  
 false keyword, 13, 16  
 FAQs (Frequently Asked  
   Questions), **32**  
 fault-tolerant applications, **524**  
 field(s)  
   classes and, 142–143  
   constructors and, 133–134  
   default, 613  
   described, **118**  
   instance, 142–143  
   key, **611**  
   organizing classes and, 129–132  
   private access to, **121**  
   size, specifying, 891–892  
   static, 121, 123–124, 173, 179, 182  
 file(s). *See also* data; random access  
   files  
   accessibility, checking, 585–598  
   binary, **580**

- file(s) (*continued*)
    - closing, **592**, 593
    - creating empty, 624–625
    - described, **580**
    - hidden, 590
    - names, 827–828, 873
    - opening, **592**
    - organization, 591–594
    - read-only, 590
    - reading from, 599–601
    - setting up programs to read, 628–629
    - statistics, displaying, 629–630
    - text, **580**
    - understanding, 580–581
    - writing to, 597–599
  - file channels
    - described, **608**
    - seekable, **608**
  - FileChannel class, 608, 609, 611, 613
  - FileOut class, 598–599
  - FileOutputStream class, 595
  - FileSystem class, 582
  - fill
    - gradient, **792**
    - patterns, **792**
  - fill method, 394, 795
  - fillArc method, **784**
  - fillOval method, **782**, 783
  - fillPolygon method, **785**
  - fillRoundRect method, 781, 782
  - final keyword, 16, **55**, 170, 181, 448, 449
  - finally block, 525, **534**, 535–536
  - finally keyword, 16, 536
  - FindDiscount class, 357–358
  - FindPrice class, 354, 355
  - FindRent class, 390
  - First class, 13, 15–18, 23, 25–27, 104, 106–107
  - FirstDialog class, 27–32
  - Fish class, 118
  - Float class, 318
  - float data type, **52**, 61
  - float keyword, 16, 52
  - floating-point data types, 61–62
  - floating-point division, **70**
  - floating-point numbers, 886, 880–881, 891
    - described, **61**
    - imprecision in, 71–73
  - FloatingPointTest class, 881
  - floor method, 184
  - floor variable, 391
  - flowcharts
    - decisions and, example of, 213
    - described, **212**
    - loops and, 260
  - FlowLayout layout manager, 655, 656, 706, **708**, 709–712, 717, 747–748
  - flush method, 596, 603
  - flushing, **593**
  - FocusListener interface, 670, 671, 727
  - folders. *See also* paths
    - changing, 871–872
    - compiling and, 24
    - described, **580**
  - font(s)
    - applets and, 832
    - changing, 652–653
    - height of, **790**, 791
    - learning more about, 787–791
    - metrics/statistics, 790, 805–809
    - using, 799
  - Font class, **652**
  - for keyword, 16, 273
  - for loops, 353–355, 364, 383
    - creating, 273–275
    - described, 273
    - enhanced, **348**, 350
    - overview, 260
  - foreach loops, **348**
  - format method, 893
  - format specifiers, **889**
  - format strings, **889**
  - Formatter class, 888–889
  - fragile classes, **442**
  - Frame class, 644
  - FULL\_WEEK constant, 218–220
  - FullTimeStudent class, 442
  - fully qualified identifier, **107**
- ## G
- garbage values, **54**
  - GeneralPath class, 797
  - get method, 129–130, 186–187, 403, 426, 442, 582
  - getAcctNum method, 483
  - getArray method, 362
  - getAscent method, 790
  - getAvailableFontFamilyNames method, 787, 788
  - getBalance method, 483
  - getBlue method, 703
  - getButton method, 727, 734
  - getBytes method, 594, 609
  - getClass method, 480
  - getClickCount method, 727, 731, 734
  - getCodeBase method, 838, 844–845
  - GetComponent method, 730, 731
  - getContentPane method, **700**, 701, 702, 774
  - getDate method, 118–119
  - getDefault method, 582
  - getDefaultToolkit method, **789**
  - getDescent method, 790
  - getDocumentBase method, 844–845
  - getEmployeeData method, 137
  - getEmpNum method, 123, 128, 173–174
  - getFontMetrics method, 790
  - getGreen method, 703
  - getHeight method, 790
  - getHoursOfTraining method, 490
  - getImage method, 838
  - getItem method, 675, 731
  - getItemCount method, 678
  - getKeyChar method, 731
  - getLeading method, 790
  - getLineMetrics method, 790
  - getLocalGraphicsEnvironment method, 787
  - getMaximumRowCount method, 678
  - getMessage method, 527, 531, 546, 548, 549
  - getModifiers method, 731
  - getName method, 471, 490, 583
  - getNameCount method, 583
  - getPoint method, 731
  - getProperty method, 603, 613
  - getRed method, 703
  - getSalary method, 387
  - getScreenResolution method, **789**
  - getScreenSize method, 789, **790**
  - getSelectedIndex method, 678, 679
  - getSelectedItem method, 678
  - getSelectedObjects method, 678
  - getSource method, 668, 731
  - getStateChange method, 731
  - getText method, 651, 660, 674
  - getTime method, 118–119
  - getTitle method, 646
  - GetUserInfo class, 78
  - GetUserInfo2 class, 79
  - GetUserInfo3 class, 80
  - getWindow method, 730, 731
  - getX method, 731, 734, 737
  - getY method, 734, 737
  - glass pane, **700**
  - goto keyword, 16



- gradient(s)
    - acyclic, **792**, 793
    - cyclic, **793**
    - fill, **792**
  - graphic(s). *See also* images
    - drawing with, 792–793
    - overview, 769–823
    - rendered, **770**
  - Graphics class, 770, 774–775, 796, 800–801
  - Graphics2D class, **792**, 795
  - GraphicsEnvironment class, 787
  - graphical user interfaces. *See* GUIs (graphical user interfaces)
  - GregorianCalendar class, 184–188, 429, 470
  - GridBagLayout layout manager, 706, 714
  - GridLayout layout manager, 706, **710**, 711–712, 717, 748–749
  - GUIs (graphical user interfaces). *See also* components; *specific components*
    - advanced topics, 699–769
    - customizing, 648–649
    - described, **6**
    - input using, using the JOptionPane class for, 81–87
    - method names and, 10
    - OOP and, relationship between, 6–7
    - program types and, 12
  - Guitar class, 432
- H**
- Harvard University, 31
  - has-a relationships, **189**
  - hash code, **481**, 483
  - hashCode method, 483
  - hasRemaining method, 609
  - heavyweight components, **644**
  - height, of fonts, **790**, 791
  - heightOfFont variable, 791
  - Hello class, 33–34
  - HelloThereNewLine class, 66
  - HelloTherePrintlnTwice class, 66
  - help, finding, 29–32
  - hexadecimal numbering system, **882**
  - HideAndGoSeekPlayer class, 448–449
  - high-level programming languages, **2**. *See also* C++ (high-level language); C# (high-level language)
  - HourlyEmployee class, 433, 470, 477
  - hoursWorked variable, 220
  - HouseData class, 192
  - .htm filename extension, 828
  - HTML (HyperText Markup Language), 22, 906, 909–910
    - applets and, 827
    - described, **827**
    - documents, writing, 828–830, 846
    - filenames, 827–828
    - images and, 839
  - .html filename extension, 828
- I**
- identifiers, for classes, **15**, 16–17
  - if keyword, 16
  - if statements, 214–224, 228, 311
    - described, **214**
    - misplaced semicolons in, 215–216
    - nested, **222**, 223–224, 364–365
    - using multiple statements in, 218–222
  - if...else statements, 228–229, 241–242
    - described, **217**
    - nested, **222**, 223–224
    - overview, 214–218
    - using multiple statements in, 218–222
  - image(s). *See also* graphics
    - adding, to applets, 838–839
    - described, **838**
    - displaying, 854–855
    - file formats, 838
    - multimedia and, 837–838
    - overview, 825–868
  - ImageIcon class, 841–844
  - ImageObserver interface, 838–839
  - immutable objects, **308**
  - implementation hiding, **108**, 109
  - implements keyword, 16, 665
  - implicit conversion, **73**, 475
  - import keyword, 16
  - import statement, **28**, 185–186, 653
  - IncrementDemo class, 272
  - indentation, 18–19, 218, 219, 224
  - indexOf method, **313**
  - IndexOutOfBoundsException, 536
  - information hiding, **121**, 441–443
  - inheritance
    - achieving good software design with, 486–487
    - advanced concepts, 469–517
    - calling constructors and, 434–438
    - described, **9**
    - information hiding and, 441–443
    - learning about, 426–430
    - multiple, **487**, 488–494
    - overview, 9–10, 425–468
    - Swing components and, 659
    - terminology, 429–430
  - init method, 830, **831**, 832, 834, 835, 836
  - initialization, of variables, **53**
  - inlining code, **448**
  - inner loops, **278**, 279–281
  - input devices, **76**
  - input dialog boxes, **81**, 82
  - InputMismatchException, 522, 530–531
  - InputStream class, 594, 595, 599, 604
  - insert method, 322
  - instanceof keyword, 16, 668
  - instanceof operator, **432**
  - instances, of classes, **7**
  - instant access files. *See* random access files
  - instantiation, 7, 118, 143–144, 500–501
  - InsuredAutomobile class, 487
  - InsuredItem class, 487
  - int data type, **52**, 57, 134–135
  - int keyword, 16, 52
  - integer(s). *See also* numbering systems; numbers
    - converting Strings to, 326–327
    - described, **57**
    - division, **70**
    - overview, 57–59
    - rounding, 886–887. *See also* integers
    - working with, 87–92
  - Integer class, **317**
  - interactive applications, **11**, 608
  - interface(s). *See also specific interfaces*
    - to called methods, **109**
    - constants and, 492–494
    - creating, 487–494
    - described, **488**
    - using, 502–505
  - interface keyword, 16
  - interpreters. *See* compilers
  - intValue method, 317
  - invalidate method, 651, 709
  - Inventory class, 119
  - InventoryItem class, 16
  - IOException, 535, 586
  - isAltDown method, 731
  - is-a-relationships, **118**
  - isControlDown method, 731

- isDigit method, 304
  - isEven method, 552–554
  - isLetter method, 304
  - isLetterOrDigit method, 304, 305
  - isLowerCase method, 304, 305
  - isPerfectScore variable, 216
  - isResizable method, 646
  - isSelected method, 674, 676, 741
  - isShiftDown method, 731
  - isUpperCase method, 303, 304, 305
  - isWhitespace method, 304, 305
  - ItemListener interface, 670–671, 727
  - itemOrdered variable, 353
  - itemStateChanged method, 675
  - iteration, **260**
- J**
- JApplet class, **826**, 827, 830–837, 844–850
  - JAR (Java ARchive) file, **494**
  - Java
    - described, **10**
    - environment, 11–12
    - overview, 10–12
    - platform, working with, 869–875
  - Java API (Application Program Interface), **32**, 910, 911
  - Java applications. *See also* applications; programs; *specific types*
    - console output and, 13–21
    - creating, 27–29, 33–37
    - described, **12**
    - that produce GUI output, 27–29
    - running, 25
  - Java Enterprise Edition (EE), **870**
  - .java filename extension, 23, 406, 494
  - Java interpreter, **11**, 12
  - Java Micro Edition (ME), **870**
  - Java SE 7 (Java Platform, Standard Edition 7), **870**, 871
  - java.awt package, 665, 702–703, 725, 787, 795
  - javac command, 24, 25
  - Javadoc, 22, 906–912
    - comments, **22**, 906–911
    - described, **906**
    - documentation, generating, 908–909
    - overview
    - tags, **906**
    - visibility types, 911–912
  - java.io package, 586
  - java.lang package, 182–183, 304, 480, 494, 522, 542, 645
  - java.swing package, 644
  - java.util package, 185, 403, 394, 494, 530, 888
  - javax.swing, 28, 644, 676, 494
  - JButton class, 661, 662–663, 665, 668, 670, 683–684, 706, 709–713, 725, 773, 833
  - JCheckBox class, 670, 671, **672**, 673–675, 671, 676, 685–688
  - JComboBox class, **677**, 678–679
  - JDemo3DRectangles class, 782
  - JDemoBorderLayout class, 707
  - JDemoCardLayout class, 712–713
  - JDemoFlowLayout class, 709–710
  - JDemoFont class, 777
  - JDemoGridLayout class, 711
  - JDemoKeyFrame class, 729, 730
  - JDemoLocation class, 773
  - JDemoManyPanels class, 717–719
  - JDemoPaint class, 771
  - JDemoRectangle class, 779–781
  - JDemoRoundRectangles class, 781
  - JDK (Java Development Kit), 22, 827, 870. *See also* SDKs (Software Development Kits)
    - described, **32**
    - layout managers and, 705
  - JFC (Java Foundation Classes), **644**
  - JFontList class, 788–789
  - JFrame class, **644**, 645–649, 654–659, 663–664, 668–671, 679–682, 700–702, 709–712, 717, 727, 772–774, 776–778, 785, 787–788, 791
  - JFrame1 class, 647
  - JFrame2 class, 648–649
  - JFrame3 class, 650
  - JFrame4 class, 652–653
  - JFrame5 class, 654
  - JFrameWithColor class, 704
  - JFrameWithExplicitContentPane class, 701–702
  - JFrameWithManyComponents class, 662, 663–664
  - JFrameWithPanels class, 715–716
  - JGradient class, 793–794
  - JHello2 class, 833
  - JHelloFrame class, 666–667
  - JLabel class, **650**, 652–654, 656, 666, 833
  - JMenu class, 738–744
  - JMenuBar class, 738–744
  - JMenuFrame class, 740–741
  - JMenuFrame2 class, 742
  - JMenuFrame3 class, 743
  - JMouseActionFrame class, 735–737
  - JMyFrame class, 657, 658
  - JOptionPane class, **27**, 28–29, 36–37, 81–87, 644
  - JPanel class, 714, **715**, 716–722, 751–755
  - JRadioButton class, 676
  - JScrollPane class, 723–724
  - JScrollPane class, 722–725
  - JStroke class, 794–795
  - JTabbedPane class, 714
  - JTextField class, **659**, 660–664, 683–684, 725
  - juncture styles, **794**
  - JVM (Java Virtual Machine), **10**, 11–12, 20, 31, 544
- K**
- K & R style, **18**
  - keepScore method, 491
  - keyboard buffers, **79**
  - KeyListener interface, 669–671, **728**, 729–730
  - keyPressed method, 728, 733, 735, 737
  - keyReleased method, 728, 733
  - keyTyped method, 728, 730, 733
  - keywords
    - list of, 16
    - reserved, 16
- L**
- Landin, Peter J., 542
  - lastModifiedTime method, 588
  - late method binding, **476**
  - layout manager(s). *See also specific layout managers*
    - advanced, 714
    - described, **654**, 655–656
    - learning more about, 705–714
  - leading, **790**
  - leaf menu items, **744**
  - len variable, 312–313
  - length field, **347**, 391–392
  - length method, 312–313, 348
  - length property, **320**
  - lexicographical comparisons, **310**
  - lightweight components, **644**

- line(s)
    - blank, 14
    - comments, **22**
    - creating, 795–796, 809–810
    - drawing, 778–787, 802–803
    - terminator characters, 66
  - lineTo method, 797
  - Linux, 32
  - listeners, **664**
  - literal
    - constants, **52**
    - strings, of characters, **13**
  - log method, 184
  - logic
    - described, **2**
    - errors, 4, **30**, 552
  - logical AND operator, **225**, 226–227, 231–232, 239–240, 352–353
  - logical NOT operator, 239
  - logical OR operator, 225–227, 231–232, 239–240
  - Long class, 318
  - long data type, **52**, 57
  - long keyword, 16, 52
  - “look and feel,” described, **648**, 649
  - loop(s). *See also* loop body; loop control variables
    - definite, **261**, 262–266
    - described, **260**
    - fusion, **284**
    - indefinite, **261**, 266–270
    - infinite, **261**
    - nested, 278–281, 289–290
    - overview, 259–299
    - performance, improving, 281–284
  - loop body
    - described, **260**
    - empty, **264**
  - loop control variables
    - decrementing, **265**
  - described, **261**
    - for loops and, 273–275
    - incrementing, **265**
    - writing definite loops and, 261–266
  - loopCount variable, 263
  - low-level programming languages, **2**
  - lvalue, **54**
- M**
- machine language, **2**
  - magic numbers, **55**
  - main method, 17–21, 104–107, 111–113, 117, 120, 123, 125, 137, 161, 178, 302, 359–360, 407, 441, 520, 523, 526, 530–531, 545, 647, 656, 658, 673, 727, 830, 890
  - Math class, 183, 184, 121, 887, 898–900
  - matrix, **388**. *See also* tables; two-dimensional arrays
  - max method, 183, 184
  - member classes
    - nonstatic, **191**
    - static, **191**
  - member-level Javadoc comments, **908**. *See also* comments
  - memory, 2, 6, 63, 112, 126. *See also* RAM (random access memory)
    - String objects and, 307
    - this references and, 173
    - variable scope and, 164
  - menu bars. *See also* menus
    - described, **700**
    - using, 751–755
  - menus. *See also* menu bars
    - described, **738**
    - using, 738–744
  - method(s). *See also* methods (listed by name)
    - abstract, **470**, 471, 726
    - accessor, **125**, 313
    - automatically imported, 182–188
    - binding, 474, **475**, 476, 477
    - body, **104**, 105, 106
    - called, **104**, 109
    - calling, **104**, 109, 112
    - calls, **104**, 114, 117–118
    - creating, 104–105
    - described, **8**
    - headers (declarations), 19, **104**, 109
    - instance, 123–125
    - mutator, **125**
    - names, 105, 113
    - nonstatic, 123–124, 173
    - overloading, **165**, 166–167, 195–196
    - overriding, **433**, 443–450
    - passing arrays to/from, 359–362, 369–370, 390–391
    - prewritten, 182–188
    - that require multiple parameters, 112–114
    - that return values, 114–118, 140–141
    - signatures, **113**, 170
    - static, 123–124, 137–141, 394, 405, 443–446
    - types, **115**
    - using, 103–155
  - method1 method, 284
  - method2 method, 284
  - methodGetsArray method, 360
  - methodGetsOneInt method, 359–360
  - methods (listed by name). *See also* methods
    - abs method, 183
    - actionPerformed method, **665**, 666, 667, 668, 712, 726–727, 772, 773, 774, 741, 833, 834, 841
    - add method, 399, **650**, 700–702, 706, 712, 715, 717, 720, 739
    - addActionListener method, **665**, 667, 670, 727
    - addAdjustmentListener method, 670
    - AddChangeListener method, 670
    - addFocusListener method, 665, 670, 730
    - addItem method, 677, 678
    - addItemListener method, 670, 727
    - addKeyListener method, 665
    - AddMouseListener method, 670
    - addPoint method, 786
    - addSeparator method, 743
    - AddWindowListener method, 670
    - append method, 322
    - applyBraces method, 431
    - atan method, 183
    - atan2 method, 184
    - billPatients method, 431
    - binarySearch method, 395, 397
    - bubbleSort method, 386–387
    - calculateInterest method, 165–166, 169–170
    - calculateInterestUsingDouble method, 167
    - calculateInterestUsingInt method, 167
    - calculatePay method, 478
    - capacity method, **320**
    - catch method, 525
    - ceil method, 184
    - charAt method, 77, 304, **313**, 322, 396
    - checkAccess method, 585, 586
    - clearRect method, **779**
    - clearRoundRect method, 781
    - clone method, 480
    - close method, 596, 600, 603
    - closePath method, 797
    - compareTo method, **311**, 312, 405, 407, 589

- methods (listed by name) (*continued*)
- conductExam method, 431
  - copyArea method, **786**, 787
  - cos method, 184
  - creationTime method, 588
  - currentTimeMillis method, 283
  - delete method, 583, 587–588
  - deleteIfExists method, 583, 588
  - destroy method, 835, **836**, 837
  - display method, 189, 190, 394, 400, 438
  - displayMessage method, 446
  - displayPrice method, 539–530
  - displayRateOfPay method, 433
  - displayRateOfPayForHourly method, 433
  - displayRules method, 491
  - draw method, 795
  - draw3DRect method, **781**, 782
  - drawArc method, **783**, 784, 796
  - drawImage method, 839, 843
  - drawLine method, **778**, 779–780, 785
  - drawOval method, **782**, 783
  - drawPolygon method, **784**, 785–786
  - drawRect method, **779**
  - drawRoundRect method, **780**, 782
  - drawString method, 774, **775**, 776–778, 798
  - endsWith method, **313**
  - equals method, 309–211, 321, 405, **483**, 484–486
  - exists method, 583, 585
  - exit method, 535, 536
  - fill method, 394, 795
  - fillArc method, **784**
  - fillOval method, **782**, 783
  - fillPolygon method, **785**
  - fillRoundRect method, 781, 782
  - floor method, 184
  - flush method, 596, 603
  - format method, 893
  - get method, 129–130, 186–187, 403, 426, 442, 582
  - getAcctNum method, 483
  - getArray method, 362
  - getAscent method, 790
  - getAvailableFontFamilyNames method, 787, 788
  - getBalance method, 483
  - getBlue method, 703
  - getButton method, 727, 734
  - getBytes method, 594, 609
  - getClass method, 480
  - getClickCount method, 727, 731, 734
  - getCodeBase method, 838, 844–845
  - getComponent method, 730, 731
  - getContentPane method, **700**, 701, 702, 774
  - getDate method, 118–119
  - getDefault method, 582
  - getDefaultToolkit method, **789**
  - getDescent method, 790
  - getDocumentBase method, 844–845
  - getEmployeeData method, 137
  - getEmpNum method, 123, 128, 173–174
  - getFontMetrics method, 790
  - getGreen method, 703
  - getHeight method, 790
  - getHoursOfTraining method, 490
  - getImage method, 838
  - getItem method, 675, 731
  - getItemCount method, 678
  - getKeyChar method, 731
  - getLeading method, 790
  - getLineMetrics method, 790
  - getLocalGraphicsEnvironment method, 787
  - getMaximumRowCount method, 678
  - getMessage method, 527, 531, 546, 548, 549
  - getModifiers method, 731
  - getName method, 471, 490, 583
  - getNameCount method, 583
  - getPoint method, 731
  - getProperty method, 603, 613
  - getRed method, 703
  - getSalary method, 387
  - getScreenResolution method, **789**
  - getScreenSize method, 789, **790**
  - getSelectedIndex method, 678, 679
  - getSelectedItem method, 678
  - getSelectedObjects method, 678
  - getSource method, 668, 731
  - getStateChange method, 731
  - getText method, 651, 660, 674
  - getTime method, 118–119
  - getTitle method, 646
  - getWindow method, 730, 731
  - getX method, 731, 734, 737
  - getY method, 734, 737
  - hashCode method, 483
  - hasRemaining method, 609
  - indexOf method, **313**
  - init method, 830, **831**, 832, 834, 835, 836
  - insert method, 322
  - intValue method, 317
  - invalidate method, 651, 709
  - isAltDown method, 731
  - isControlDown method, 731
  - isDigit method, 304
  - isEven method, 552–554
  - isLetter method, 304
  - isLetterOrDigit method, 304, 305
  - isLowerCase method, 304, 305
  - isResizable method, 646
  - isSelected method, 674, 676, 741
  - isShiftDown method, 731
  - isUpperCase method, 303, 304, 305
  - isWhitespace method, 304, 305
  - itemStateChanged method, 675keepScore method, 491
  - keyPressed method, 728, 733, 735, 737
  - keyReleased method, 728, 733
  - keyTyped method, 728, 730, 733
  - lastModifiedTime method, 588
  - length method, 312–313, 348
  - lineTo method, 797
  - log method, 184
  - main method, 17–21, 104–107, 111–113, 117, 120, 123, 125, 137, 161, 178, 302, 359–360, 407, 441, 520, 523, 526, 530–531, 545, 647, 656, 658, 673, 727, 830, 890
  - max method, 183, 184
  - method1 method, 284
  - method2 method, 284
  - methodGetsArray method, 360
  - methodGetsOneInt method, 359–360
  - methodThat
    - UsesInstanceAttributes method, 163
  - methodWithInvalidStatements method, 160
  - methodWithNestedBlocks method, 159
  - min method, 184
  - mouseClicked method, 733, 735, 737
  - mouseDragged method, 733
  - mouseEntered method, 733, 735
  - mouseExited method, 733, 735
  - mousePressed method, 733
  - mouseReleased method, 733, 735, 737
  - moveTo method, 797
  - newByteChannel method, 608, 609
  - newInputStream method, 599
  - newOutputStream method, 597

next method, 77, 78, 79, 80  
 nextByte method, 77  
 nextChar method, 77  
 nextDouble method, 77, 79, 80  
 nextFloat method, 77  
 nextInt method, 77, 79, 80, 81  
 nextLine method, 76–81, 601  
 nextLong method, 77  
 nextShort method, 77  
 notExists method, 583  
 notify method, 480  
 notifyAll method, 480  
 outputLabel method, 280  
 outputSound method, 492  
 paint method, **770**, 771–777, 780, 792, 835, 842–843  
 paintIcon method, 841  
 parseDouble method, 84, **318**, 606  
 parseFloat method, 318  
 parseInt method, 84, 188, 318, 606, 620  
 parseLong method, 318  
 play method, 432, 844, 845  
 playNote method, 492  
 position method, 608  
 pow method, 184  
 predictRaise method, 109–112, 115–116, 117  
 predictRaiseUsingRate method, 112–113  
 print method, 15, 67, 76, 78, 314  
 printf method, 887, **888**, 891–893  
 println method, 14–15, 17–18, 20, 25, 28, 63, 66–67, 76, 82, 104, 106, 108, 116, 120, 158, 214–215, 220, 222, 307, 314, 433, 445, 588, 887–888, 890  
 printStackTrace method, 546, 547  
 random method, 184, 898–900  
 read method, 599, 600, 608  
 readBasicFileAttributes method, 588  
 readLine method, 600, 604  
 remove method, 650, 700, 702  
 removeAllItems method, 678  
 removeItem method, 678  
 repaint method, **770**, 771–775  
 replace method, **313**, 651  
 rewind method, 609  
 round method, 184, 887  
 secondMethod method, 161  
 set method, 129, 130, 426  
 setAlignment method, 708  
 setBackground method, 702, 716  
 setBounds method, 646, 658  
 setCharAt method, 322

setColor method, 10, 774, 776–778, 792  
 setDate method, 118–119  
 setDefaultCloseOperation method, 657, 658, 648  
 setDefaultLookAndFeel  
   FeelDecorated method, 648–649  
 setEditable method, 660, 678  
 setEmpNum method, 124, 127, 128, 171  
 setEnabled method, **669**  
 setFont method, **652**, 774, 776–777  
 setForeground method, 702  
 setHeight method, 10  
 setHoursOfTraining method, 490  
 setIDNum method, 442  
 setJMenuBar method, 739  
 setLayout method, 702, 708, 717  
 setLayoutManager method, 700  
 setLength method, 320, 321  
 setLocation method, 658, **772**, 773–774  
 setMaximumRowCount method, 678  
 setMnemonic method, 743–744  
 setName method, 471, 473, 490  
 setResizable method, 646  
 setSelected method, 741, 674, 675  
 setSelectedIndex method, 678  
 setSelectedItem method, 678  
 setSize method, 646, 657  
 setStroke method, **794**  
 setText method, 651, 660, 674, 675, 833  
 setTime method, 118–119  
 setTitle method, 646, 657  
 setToolTipText method, **663**  
 setValues method, 163  
 setVisible method, 646, 647, 657–658, 676  
 show method, 647  
 showConfirmDialog method, **85**  
 showInputDialog method, 81, 82, 83, 316, 317  
 showMessageDialog method, 14, 28, 68, 107, 307  
 showOrigins method, 443, 445  
 shuffle method, 491  
 simpleMethod method, 167–169  
 size method, 399, 588, 608  
 sleep method, 275  
 sort method, 392, 394, 397, 403  
 speak method, 471–476, 478, 489, 490  
 split method, 605

sqrt method, 184  
 square method, 108  
 square1 method, 108  
 square2 method, 108  
 start method, 834, 835, **836**  
 startsWith method, **313**  
 static (fixed) method binding, **476**  
 stop method, 9, 835, **836**  
 stringWidth method, **791**  
 substring method, 314  
 talkingAnimal method, 476–477  
 toAbsolutePath method, 584–585  
 toLowerCase method, 304, 305, 312  
 toString method, **313**, 314, 403, 405, 480, 481–483, 485, 583, 679  
 toUpperCase method, 303, 304, 305, 312  
 turn method, 9  
 update method, 776  
 validate method, 651, 709, 834  
 valueOf method, 317, 318, 405, 407  
 work method, 489, 490  
 write method, 594, 596, 601, 603, 608, 612  
 MethodsThatUseAnEmployee  
   class, 136  
 methodThatUsesInstanceAttributes  
   method, 163  
 methodWithInvalidStatements  
   method, 160  
 methodWithNestedBlocks method, 159  
 min method, 184  
 mission critical, use of the term, **523**  
 mnemonic, **743**  
 modulus (remainder) operator, 69, **70**, 900  
 MortgageLoan class, 192  
 mouse events, 725–727, 731, 733–739  
 MouseAdapter class, 727  
 mouseClicked method, 733, 735, 737  
 mouseDragged method, 733  
 mouseEntered method, 733, 735  
 MouseEvent class, **725**, 726, 727, 731, 734  
 mouseExited method, 733, 735  
 MouseInputListener interface, **733**  
 MouseListener interface, 670, 671, 727, **733**  
 MouseMotionListener interface, 670, 727, **733**  
 mousePressed method, 733  
 mouseReleased method, 733, 735, 737

MouseWheelListener interface,  
728, 734  
moveTo method, 797  
multidimensional arrays, **392**  
multimedia. *See also* graphics;  
images; sound  
described, **837**  
understanding, 837–838  
multiple inheritance, **487**, 488–494  
multiplication operator, 69  
multiply and assign operator, **270**  
MusicalInstrument class, 432, 492  
myNewSalary variable, 116

## N

named constants  
declaring, 54–46  
described, **54**  
NaN (Not a Number), **184**  
native keyword, 16  
new keyword, 16, 307, 319–320,  
345, 350, 474  
new operator, **126**  
newByteChannel method, 608, 609  
newInputStream method, 599  
newline character, 66, 591, 890  
newOutputStream method, 597  
next method, 77, 78, 79, 80  
nextByte method, 77  
nextChar method, 77  
nextDouble method, 77, 79, 80  
nextFloat method, 77  
nextInt method, 77, 79, 80, 81  
nextLine method, 76–81, 601  
nextLong method, 77  
nextShort method, 77  
nonvolatile storage, **580**  
NoSuchFileException, 587  
NOT operator, **237**, 238  
Notepad, 11, 874  
notExists method, 583  
notify method, 480  
notifyAll method, 480  
null keyword, 13, 16  
null Strings, **68**  
NullPointerException, 548, 774  
NUMBER\_OF\_SCORES constant,  
347  
NumberFormatException, 316  
numbering systems. *See also*  
numbers  
binary, **878**, 879  
decimal, **878**, 880, 886–887, 891  
hexadecimal, **882**

overview, 878–881  
numbers. *See also* integers;  
numbering systems  
pseudorandom, **898**  
random, 897, **898**, 899–903  
representing, 880–881  
rounding, 886–887  
NumbersDialog class, 68–69  
numeric constants, **52**  
numeric type conversion, 73–75  
numOfItems variable, 356–357

## O

object(s)  
anonymous, **307**  
arrays of, 349–352, 366–368,  
385–387  
comparing, 307–312  
declaring, 126–129, 307–312  
described, 7  
immutable, **308**  
-oriented programs, **6**, 7  
references to, 126, 501–502  
Object class, 594, 644–645, **479**,  
480–486  
octothorpe. *See* pound sign (#)  
OMG (Object Management  
Group), 427  
one-dimensional arrays, **388**,  
389–390  
operands, **69**  
operator(s). *See also specific  
operators*  
arithmetic, **69**, 270–272  
binary, **69**  
Boolean, 59  
precedence, **70**, 238–240  
relational, **59**, 60–61, 216–217  
Orthodontist class, 431  
outer loops, **278**, 279–281  
output  
devices, **15**  
formatting, 885–895  
outputLabel method, 280  
outputSound method, 492  
OutputStream class, 594, 595, 596,  
597–599  
ovals, creating, 786  
OverridingVariable class, 161, 162

## P

package(s). *See also specific  
packages*  
creating/using, 494–496, 504–507  
default, **495**

described, **28**  
overview, 182  
package access specifier, 105  
package keyword, 16  
paint method, **770**, 771–777, 780,  
792, 835, 842–843  
paintIcon method, 841  
painting  
application-triggered, 770  
described, **770**  
system-triggered, **770**  
parameter(s)  
actual, **114**  
adding, to methods, 108–114  
constructors and, 171–173  
described, **108**  
formal, **114**  
method overloading and, 165–166  
methods that require multiple,  
112–114  
superclasses and, 476–477  
parent classes, **429**  
parse, use of the term, **84**  
parsing, **30**  
parseDouble method, 84, **318**, 606  
parseFloat method, 318  
parseInt method, 84, 188, 318, 606,  
620  
parseLong method, 318  
PartTimeStudent class, 442  
Party class, 118–119  
Pascal casing, **17**  
PassArray class, 361  
PassArrayElement class, 359–360  
path(s)  
absolute, 584–585  
converting, 584–585  
creating, 582–583  
deleting, 587–588  
delimiters, **581**  
described, **581**  
relative, 584–585  
retrieving information about,  
583–584  
Path class, 581–591, 608  
PathDemo class, 584  
PathDemo2 class, 585  
PathDemo3 class, 586  
PathDemo4 class, 587  
PathDemo5 class, 588–589  
PathDemo6 class, 589–590  
pattern Strings, 893  
payRate variable, 75  
Payroll class, 118–119  
Periodontist class, 431

permanent storage devices, **580**  
 PI constant, 183  
 PI field, 122  
 Piano class, 492  
 pixels, **646**  
 PizzaConstants interface, 492–494  
 PizzaDemo class, 493  
 play method, 432, 844, 845  
 playNote method, 492  
 point size argument, **652**  
 polygons, 784–786, 797  
 polymorphism  
   ad-hoc, 476  
   described, **9**  
   inheritance and, 432, 434, 475  
   overview, 9–10, 432–434  
   pure (inclusion), **476**  
   subtype, **434**  
 position method, 608  
 POSIX, 590  
 postfix decrement operator, **271**  
 postfix increment operator, **270**,  
   271, 286–288  
 posttest loops, **276**  
 pow method, 184  
 predictRaise method, 109–112,  
   115–116, 117  
 predictRaiseUsingRate method,  
   112–113  
 preferred size, of components, **708**  
 PreferredCustomer class, 439  
 prefix decrement operator, **271**  
 prefix increment operator, **270**,  
   271, 286–288  
 pretest loops, **276**  
 PriceList class, 539–530  
 PriceListApplication2 class, 540–541  
 primary keys, **130**  
 priming input, **268**  
 priming read, **268**  
 primitive data types, 83, 116  
   arrays and, 344, 346, 385  
   classes and, 134–135  
   described, **52**  
   parameters and, 109  
 print method, 15, 67, 76, 78, 314  
 printf method, 887, **888**, 891–893  
 println method, 14–15, 17–18, 20,  
   25, 28, 63, 66–67, 76, 82,  
   104, 106, 108, 116, 120, 158,  
   214–215, 220, 222, 307, 314,  
   433, 445, 588, 887–888, 890  
 printStackTrace method, 546, 547  
 PrintStream class, 15, 594, 595

private access specifier, 105, **121**,  
   442. *See also* access  
   specifiers  
 private keyword, 16, 441, 442  
 procedural programming, **5**, **6**  
 procedures, **5**  
 ProfessionalBaseballPlayer class,  
   443–446  
 ProfessionalBasketBall Player class,  
   446–447  
 ProfessionalHideAnd  
   GoSeekPlayer class,  
   448–449  
 program(s). *See also* applications;  
   Java applications  
   described, **2**  
   files, **580**  
   statements, **2**  
   types, overview of, 12  
 program comments. *See* comments  
 programmer-defined data types,  
   **135**  
 promotions, **73**, 475  
 prompts, **78**, 871, 909  
 properties, of objects, **7**  
 protected access specifier, 16, 105,  
   442. *See also* access  
   specifiers  
 protected keyword, 16, 442  
 pseudocode, **212**  
 pseudorandom numbers, **898**  
 public access specifier, 105. *See also*  
   access specifiers  
 public classes, saving, 23  
 public keyword, 16, 121, 441, 442  
 pure (inclusion) polymorphism, **476**

## Q

quizScore variable, 214, 215, 216,  
 217–218

## R

ragged arrays, **392**  
 RAISE constant, 110, 111  
 RAM (random access memory),  
   **580**, 591, 633. *See also*  
   memory  
 random access files  
   creating, 622–624  
   described, **608**  
   overview, 607–611  
   random access to, 620–622  
   reading records from, 618–622  
   writing records to, 611–618  
 Random class, 900–901  
 random method, 184, 898–900  
 random numbers, 897, **898**,  
   899–903  
 RandomAccessTest class, 609–618  
 range checks, **227**, 228–232  
 range matches  
   described, **357**  
   searching arrays for, 356–358  
 rateOfPay variable, 5  
 READ argument, 585, 586  
 read method, 599, 600, 608  
 readability, improving, 16  
 readBasicFileAttributes method, 588  
 ReadEmployeeFile class, 604, 605,  
   607  
 ReadEmployeeFile2 class, 606–607  
 ReadEmployeesRandomly class,  
   620–622  
 ReadEmployeesSequentially class,  
   618–620  
 Reader class, 594, 596  
 ReadFile class, 599–600  
 readLine method, 600, 604  
 real-time applications, **608**  
 RealEstateListing class, 191–192  
 records  
   described, **592**  
   reading, 618–622  
   writing, 611–618  
 rectangles  
   creating. *See also*  
   drawing, 779–781  
   shadowed, 781–782  
 reference(s). *See also* reference types  
   described, **174**  
   overview, 303  
   passed by, **360**  
   this, 164, 173, **174**, 175–178  
 reference types. *See also* references  
   arrays and, 360  
   described, **52**  
   overview, 360  
 relational operators  
   comparing objects using, 216–217  
   described, **59**  
   overview, 59–61  
 relative path, **582**, 583  
 remainder and assign operator, **270**  
 remainder (modulus) operator, 69,  
   **70**, 900  
 remove method, 650, 700, 702  
 removeAllItems method, 678  
 removeItem method, 678

- repair method, **770**, 771–775
  - replace method, **313**, 651
  - reserved keywords, list of, 16
  - return keyword, 16
  - return statement, **115**, 116
  - return type, **105**
  - rewind method, 609
  - robustness, **524**
  - root directories, **580**
  - round method, 184, 887
  - run time
    - described, **3**
    - errors, **31**, 551
  - runtime exceptions, **520**, 543, 551
  - RuntimeException, 543, 551
  - rvalue, **54**
- S**
- Sailboat class, 9
  - SalariedEmployee class, 470, 477
  - SalaryDialog class, 83–85
  - saleAmount variable, 225
  - sandboxes, **828**
  - scalar (primitive) variables, **346**
  - Scanner class, 52, 76–81, 495–496, 522, 530, 599
  - School class, 190
  - SchoolDemo class, 190
  - scientific notation, **61**
  - scope
    - “comes into,” described, **158**
    - demonstrating, 193–194
    - described, **56**
    - “goes out of,” described, **158**
    - overview, 158–165
  - screen
    - coordinates, examining, 801–802
    - statistics, 789–790
  - ScreenOut class, 596–598
  - SDKs (Software Development Kits), **32**, 870. *See also* JDK (Java Development Kit)
  - SearchList class, 351–352
  - secondMethod method, 161
  - seeds, **898**
  - semantic errors, **3**
  - sequence structure, **212**
  - sequential data files, creating/using, 601–607
  - sequential file access
    - described, **592**
    - overview, 618–631
    - to random access files, 618–629
  - set method, 129, 130, 426
  - setAlignment method, 708
  - setBackground method, 702, 716
  - setBounds method, 646, 658
  - setCharAt method, 322
  - setColor method, 10, 774, 776–778, 792
  - setDate method, 118–119
  - setDefaultCloseOperation method, 657, 658, 648
  - setDefaultLookAndFeelDecorated method, 648–649
  - setEditable method, 660, 678
  - setEmpNum method, 124, 127, 128, 171
  - setEnabled method, **669**
  - setFont method, **652**, 774, 776–777
  - setForeground method, 702
  - setHeight method, 10
  - setHoursOfTraining method, 490
  - setIDNum method, 442
  - setJMenuBar method, 739
  - setLayout method, 702, 708, 717
  - setLayoutManager method, 700
  - setLength method, 320, 321
  - setLocation method, 658, **772**, 773–774
  - setMaximumRowCount method, 678
  - setMnemonic method, 743–744
  - setName method, 471, 473, 490
  - setResizable method, 646
  - setSelected method, 741, 674, 675
  - setSelectedIndex method, 678
  - setSelectedItem method, 678
  - setSize method, 646, 657
  - setStroke method, **794**
  - setText method, 651, 660, 674, 675, 833
  - setTime method, 118–119
  - setTitle method, 646, 657
  - setToolTipText method, **663**
  - setValues method, 163
  - setVisible method, 646, 647, 657–658, 676
  - shapes
    - arcs, 780, 781, 783–784, 786
    - drawing, 778–787
    - ovals, 786
    - polygons, 784–786, 797
    - rectangles, 779–781, 786
    - working with, 810–811
  - short data type, **52**, 57
  - short keyword, 16, 52
  - short-circuit evaluation, **226**, 227, 282
  - short-circuit operators, 282
  - show method, 647
  - showConfirmDialog method, **85**
  - showInputDialog method, 81, 82, 83, 316, 317
  - showMessageDialog method, 14, 28, 68, 107, 307
  - showOrigins method, 443, 445
  - shuffle method, 491
  - significant digits, **61**
  - simpleMethod method, 167–169
  - single-alternative if statement. *See* if...else statements
  - single-dimensional array. *See* one-dimensional arrays
  - single-precision floating-point numbers, **62**
  - size method, 399, 588, 608
  - sleep method, 275
  - Snake class, 472, 474, 478
  - Solaris, 32, 581
  - SomeRandomNumbers class, 899
  - SomeRandomNumbers2 class, 901–902
  - SomeRandomNumbers3 class, 902–903
  - sort method, 392, 394, 397, 403
  - sorting
    - array elements, 382–387
    - arrays of objects, 385–387
    - described, **382**
  - sound
    - adding, to applets, 844–845
    - file formats, 844
    - overview, 825–868
    - playing, 855–857
  - source code. *See* code
  - source, of events, **664**
  - speak method, 471–476, 478, 489, 490
  - split method, 605
  - sqrt method, 184
  - square method, 108
  - square1 method, 108
  - square2 method, 108
  - stack trace
    - described, **523**
    - history list, **523**
  - standard input devices, **76**
  - standard output devices, **15**
  - StandardOpenOption arguments, 597, 608
  - start method, 834, 835, **836**
  - startsWith method, **313**
  - state, of objects, 7



- statement(s). *See also* if statements;  
 if...else statements  
 assert, **552**  
 break, 356  
 described, **2**  
 dual-alternative if, **217**  
 efficient writing of, 71  
 empty, **216**  
 ending, with a semicolon, 13  
 executing, **2, 3**  
 import, **28**, 185–186, 653  
 return, **115**, 116  
 throw, **525**, 526–529  
 unreachable, **116**
- static import feature, **586**
- static keyword, **19**, 105, 121  
 123, 586
- static (fixed) method binding, **476**
- stop method, 9, 835, **836**
- storage devices, **580**
- streams  
 described, **593**  
 overview, 591–594
- String(s)  
 converting, to numbers, 316–319  
 creating, 319–324  
 data problems, 302–303  
 exception handling and, 548  
 file input/output and, 583, 603,  
 605, 609  
 fonts and, 791  
 manipulating arrays of, 350–352  
 null (empty), **68**  
 objects, comparing, 307–312  
 pattern, **893**
- String class, **64**, 67, 303–304,  
 307–316, 324–327
- String variable, **307**, 308–312
- StringBuffer class, **303**, 319–324
- StringBuilder class, **303**, 319–324,  
 327–328
- StringBuilderDemo class, 320–321
- stringWidth method, **791**
- strokes  
 described, **794**  
 setting, 794–795  
 using, 809–810
- strongly typed language, **53**
- stubs, **105**
- Student class, 174–179, 181–182,  
 441, 442
- style argument, **652**
- sub variable, 347
- subclass(es)  
 creating, 452–454  
 described, **429**  
 instantiating objects from,  
 500–501  
 objects, creating arrays of,  
 477–479  
 overriding methods and, 443–450
- subscripts, **343**, 346–348
- substring method, 314
- subtract and assign operator, **270**
- subtraction operator, 69
- super keyword, 16, 434, 437, 440,  
 657
- superclass(es), 432–451, 456–458  
 creating, 450–451  
 described, **429**  
 methods, 432–434, 438–440,  
 443–450  
 used as method parameter types,  
 476–477
- Swing class, 650, 700, 722
- Swing components. *See also*  
 components; *specific*  
*components*  
 described, **644**  
 event-driven programs and,  
 664–669  
 overview, 644–698  
 understanding, 644–645
- switch keyword, 16, 233, 234
- switch statement, **232**, 233–236
- symbolic constants. *See* named  
 constants
- synchronized keyword, 16
- syntactic salt, **542**
- syntactic sugar, **542**
- syntax  
 described, **2**  
 errors, **3**, 24, 551
- System class, 14–15, 28, 120
- T**
- tables, **388**. *See also* two-  
 dimensional arrays
- tag(s)  
 attributes, **829**  
 described, 829  
 Javadoc, **906**
- talkingAnimal method, 476–477
- TalkingAnimalDemo class, 476–477
- temp variable, 387
- ternary operator, **236**
- TestBankAccount class, 482
- TestCharacter class, 304–306
- TestCustomer class, 439–440
- TestEmployeeMethods class, 164
- TestPlayer class, 179–180
- TestProPlayer class, 446
- TestStudent class, 175
- text files, **580**
- TextPad, 874–875
- this keyword, 16, 440
- this references, 164, 173, **174**,  
 175–178
- throw keyword, 16
- throw statements, **525**, 526–529
- Throwable class, 527, 548
- throws keyword, 16
- timers, 199–200
- toAbsolutePath method, 584–585
- TOCTTOU bug, **587**
- tokens, 76
- toLowerCase method, 304, 305, 312
- tool tips, **663**, 664
- Toolkit class, 789–790
- top-level containers, **700**
- toString method, **313**, 314, 403, 405,  
 480, 481–483, 485, 583, 679
- toUpperCase method, 303, 304,  
 305, 312
- transient keyword, 16
- Tree class, 429
- true keyword, 13, 16
- try blocks, **525**, 526–529
- try keyword, 16, 525, 536
- TryToCompareStrings class,  
 302–303, 309–310
- turn method, 9
- two-dimensional arrays, **388**,  
 389–393, 409–411
- type casting, 74
- type-ahead buffer, **79**
- typeface argument, **652**
- type-wrapper classes, **83**
- U**
- UI components, **644**. *See also*  
 components
- UML (Unified Modeling Language)  
 described, **426**  
 diagrams, 426–428  
 inheritance and, 428
- unary cast operator, **74**
- unary operator, **74**
- Unicode, 344, 580, 591, 731  
 described, **15**  
 overview, 881–882  
 values, character equivalents to,  
 63–64

unifying type, **73**  
 UNIX, 185, 581, 583, 590  
 unnamed constant, **52**  
 unreachable statements, **116**  
 upcast operands, **432**  
 update method, 776  
 UseAnimal class, 472–473  
 UseCustomerAccount class, 550  
 user interfaces. *See* GUIs (graphical user interfaces)

## V

validate method, 651, 709, 834  
 validating data  
   described, **268**  
   writing loops for, 285–286  
 value  
   comparing, 308–312  
   passed by, **360**  
   returning, **105**, 114–118, 140–141  
 valueOf method, 317, 318, 405, 407  
 variable(s). *See also* scope  
   declarations, **53**  
   described, **5**  
   instance, **119**  
   overriding, **161**, 162–163  
   overview, 52–57  
   passing, 361–362  
   redeclaring, **161**  
   scalar (primitive), **346**  
   static, 178–180

Vehicle class, 9  
 VerifyCode class, 396–397  
 viewports, **722**  
 Violin class, 492  
 virtual classes, **470**. *See also*  
   abstract classes  
 virtual key codes, **728**  
 virtual method calls, **448**  
 Visual Basic (Microsoft), 536  
 void, **19**  
 void keyword, 16  
 void methods, 116  
 volatile keyword, 16  
 volatile storage, **580**

## W

Web browsers. *See* browsers  
 while keyword, 16  
 while loop(s), 260–270, 273  
   described, **261**  
   performance, improving, 281–282  
 whitespace, **18**  
 widgets, 644  
 wildcard symbols, **185**  
 window decorations, **648**  
 windowed applications, **12**  
 WindowListener interface, 670, 728  
 Windows (Microsoft)  
   configuring, to work with the Java  
     SE Development kit,  
     870–871

JDK for, 32  
   path names and, 583  
 WORA (“Write once, run  
   anywhere”), **12**  
 work method, 489, 490  
 Worker interface, 489  
 WorkingDog class, 489, 490  
 wrapped arrays, **608**  
 wrapper classes, **317**, 318  
 write method, 594, 596, 601, 603,  
   608, 612  
 WriteEmployeeFile class, 601,  
   603, 604

## X

x-axis, 732, 776–777  
 x-coordinates, **732**, 776–780,  
   783–784, 786–787,  
   795–796, 841  
 XHTML (Extensible Hypertext  
 Markup Language),  
**827**, 829

## Y

y-axis, 732  
 y-coordinates, **732**, 779–780,  
   783–784, 786–787,  
   795–796, 841

## Z

zero, comparisons to, 282